

Changes for the Better

for a greener tomorrow



ENERGY RECOVERY VENTILATORS <LOSSNAY>
AIR CURTAIN
AIR CONDUCTING FAN
JET TOWEL



Mitsubishi Electric Corporation

Over 90 years of Excellence

From pushing the limits of precision in microelectronics to producing entire space satellites, Mitsubishi Electric has built up a reputation for innovating key technologies and achieving technological feats in a wide range of fields for nearly a century.

Especially for a long-term investment like photovoltaic products, it is crucial to have a reliable and stable manufacturer to honor its warranties and provide lasting support. Mitsubishi Electric is the brand name that you can trust to be there for you in the long run... For centuries to come.

Just a few of our achievements



Power Semiconductors

DIP-IPMs are compact power semiconductors that realize dramatically enhanced efficiency. Used in home appliances and other diverse applications, they contribute to significant energy savings.



Transforming Equipment Development Technologies

We verify the reliability of our transforming equipment by simulating severe natural environments, including extreme cold/heat, lightning strikes and earthquakes at the world's largest testing facilities.



Hole-piercing Laser-processing Technologies for Printed Circuit Boards

High-speed, precise laser processing enables printed circuit boards to be pierced at 4,500 holes per second; an FA technology supporting the evolution of smartphones.



Large-scale, High-purity Plastic Recycling

Our recycling technology recovers up to 70% of plastic for use in new products. Typically, only about 6% is recoverable.



Compact EV motor drive systems

Our 60kW electric vehicle (EV) motor drive system prototype with a reduced cubic volume of 14.1 liters is the smallest EV motor drive in this category.

1921

Mitsubishi Electric is branched off from Mitsubishi corporation as a separate identity



1928

E52, the first large-scale electric locomotive produced in Japan



1935

Commencement of elevator & escalator production



1953

Launched first commercial television



1964

Produced radar equipment for the weather station atop Mt. Fuji



1980

Debut of Diamond Vision display at Dodger Stadium in the United States



1990

Launched world's first commercial car navigation system incorporating GPS



2000

Adopted MISTY® technology as encryption standard for 3rd-generation mobile phones



2007

Completed 173-meter-tall elevator testing tower (world's tallest at the time)



2008

Launched SUPERBIRD-C2, Japan's first domestically produced commercial satellite



2011

Debut of Hayabusa Series E5, holder of the Japanese speed record for a train



2014

Unveiled world's largest full ultra-HD video display* in Times Square, New York City

*As of Nov. 18, 2014 (based on total area)

C O N T

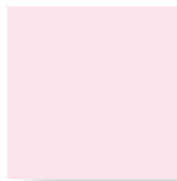
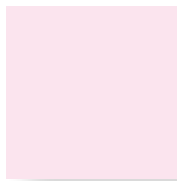
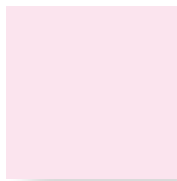
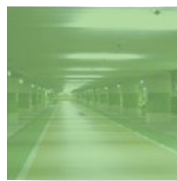
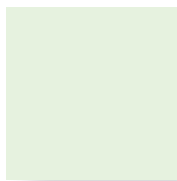
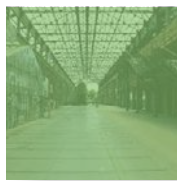
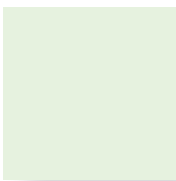
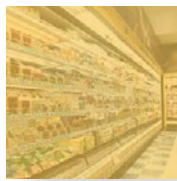
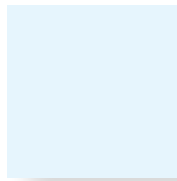
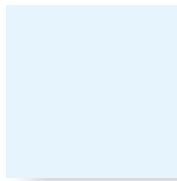
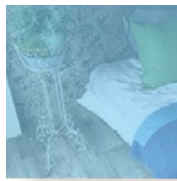
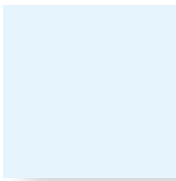
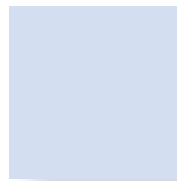
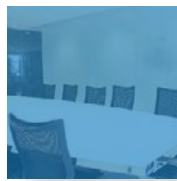
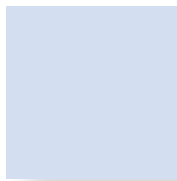
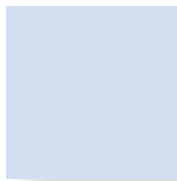







E N T S

■ Lossnay	5 - 10
■ LGH Series	11 - 26
■ LGF-100GX-E	27 - 30
■ GUF Series	31 - 36
■ VL-220CZGV-E	37 - 42
■ VL-100 (E) U ₅ -E	43 - 46
■ Accessories	47 - 48
■ Air curtain	49 - 52
■ Air conducting fan	53 - 56
■ Jet Towel	57 - 60

Heat Recovery Ventilator

Lossnay

Line up

Application	Model	Air volume												
		100 CMH	150 CMH	250 CMH	350 CMH	400 CMH	500 CMH	650 CMH	800 CMH	1000 CMH	1500 CMH	2000 CMH	2500 CMH	
Commercial Use	LGH-RVX Series 		●	●	●		●	●	●	●	●	●		
	LGH-RVXT Series NEW 										●	●	●	
	LGF-100GX-E 									●				
	GUF Series 						●		●					
Residential Use	LGH-50RSDC-E1 					●								
	VL-220CZGV-E NEW 			●										
	VL-100(E)U₅-E 	●												

■ LGH-RVX Series

This commercially oriented system can be utilized virtually anywhere with high performance and functions.

■ LGH-RVXT Series

Thin large air volume models in LGH series with high performance and functions.

■ LGH-50RSDC-E1

Centralized ventilation for residential use with energy heat exchange. (for Europe only)

■ LGF-100GX-E

Floor standing heat recovery ventilation units which is compliant with VDI 6022 (German regulation)(for Europe only)

■ GUF Series

Heat recovery with heating and cooling system using the heat resource of City Multi outdoor unit.

■ VL-220CZGV-E

Centralized ventilation for residential use with sensible heat exchange.

■ VL-100(E)U₅-E

Wall mount model. Particularly suitable for houses and small offices.

• While every effort has been made to represent product colours herein accurately, slight deviations from actual colour may be noted due to the printing process.

Indoor air quality inside a building is optimised through

Lossnay is a total heat exchange ventilation system that uses paper characteristics to perform temperature (sensible heat) and humidity (latent heat) exchange.

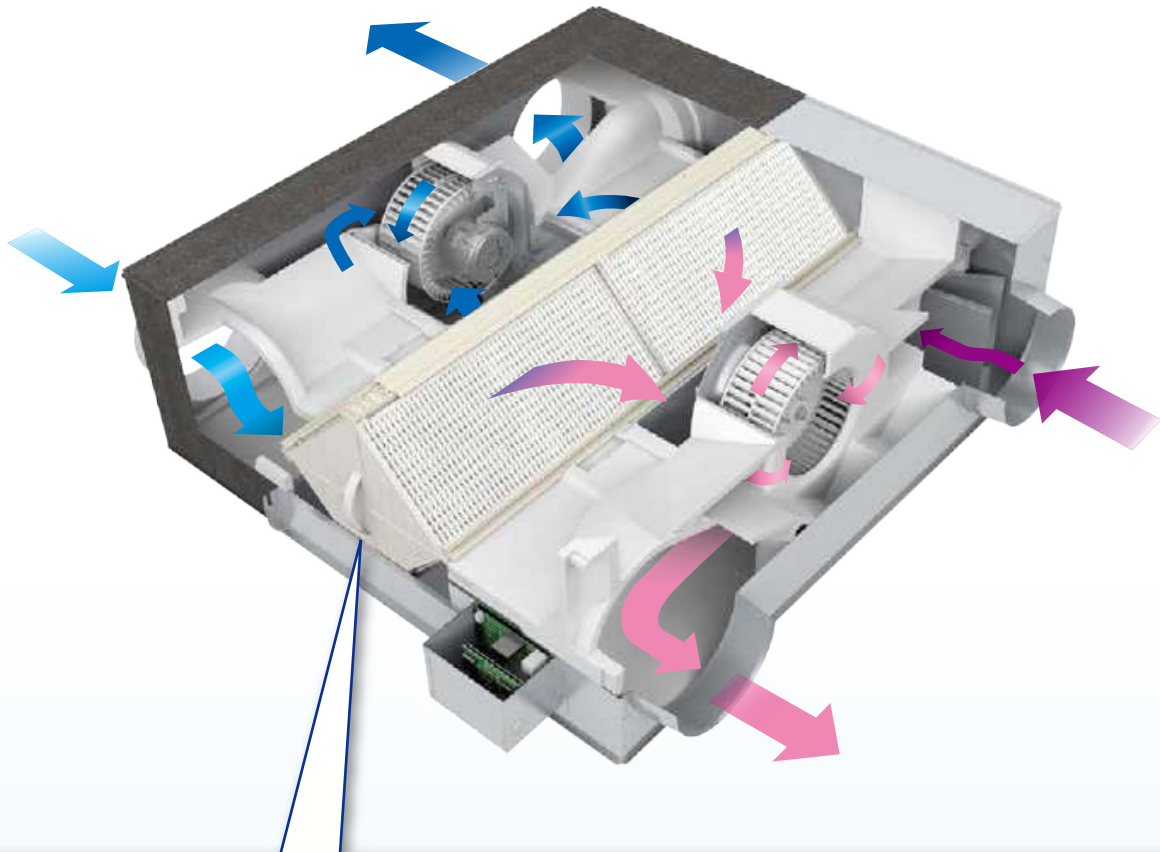

■ The concept of sensible heat and latent heat exchange using Lossnay core

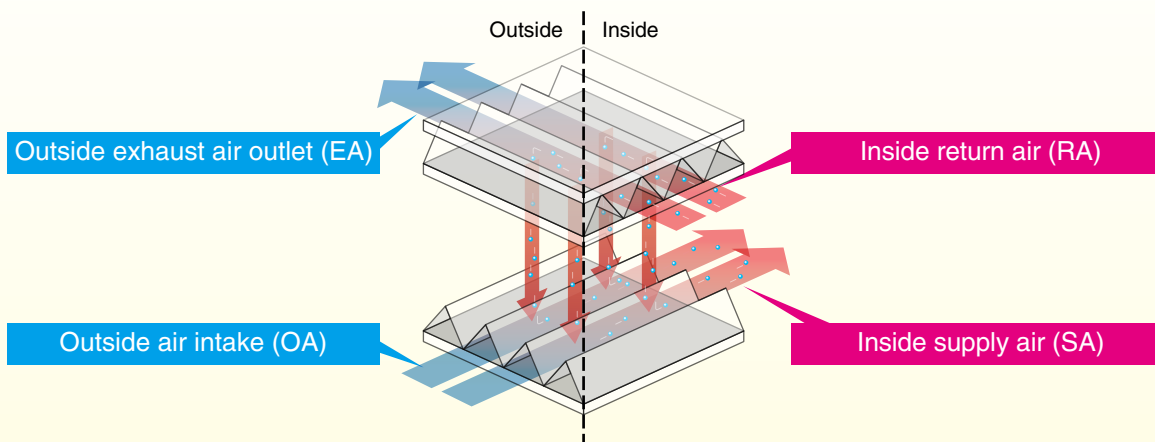

After launching its first generation in 1970, Lossnay has evolved by always looking ahead of the air conditioning needs of the times, which continue to diversify.

The technology is used in a wide range of applications and units have been widely adopted in residences, office buildings, hospitals, schools, etc.

temperature and humidity exchange by Lossnay

The need for ventilation

The need for fresh air

Poor air quality can be attributed to many problems arising in the workplace and in the home. It is believed to contribute to a significant loss in productivity, low morale and higher rates of sickness. Providing good ventilation in residential and commercial buildings is to provide conditions under which people can live and work comfortably and safely.

Effect of oxygen deficiency on human body

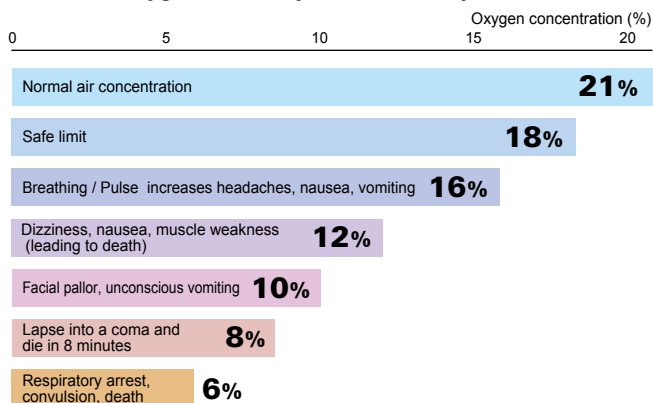

Source: SE Series "Safety of New Construction" Author: "Oxygen Deficiency" Doctor of Medicine/ Hiroshi Yamaguchi, issued by Research Institute for Safety Engineering

The need for appropriate humidity management

Viruses such as influenza are found to be active and the survival rate high in low humidity and dry environments.

In general, the survival rate is said to decrease significantly when the relative humidity is 50% or more the temperature is 20°C. During the winter, keeping an appropriate humidity and heating temperature can help prevent influenza.



Influenza virus survival rate

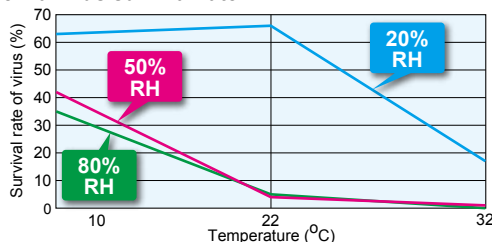

Source: Survival rate after 6 hours by G.J. Harper, Takehito Takano and other "Health Housing Science Seminar"

Activity range of microorganisms by humidity range

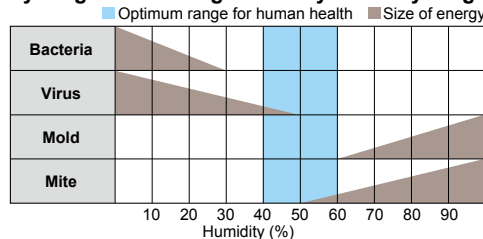

Source: ASHRAE Trans. 91 - 1B (1985)

What can be improved by introducing Lossnay?

Ventilation with maximised comfort

In summer

Air similar to the conditions of the cooled (dehumidified) indoor air is supplied.

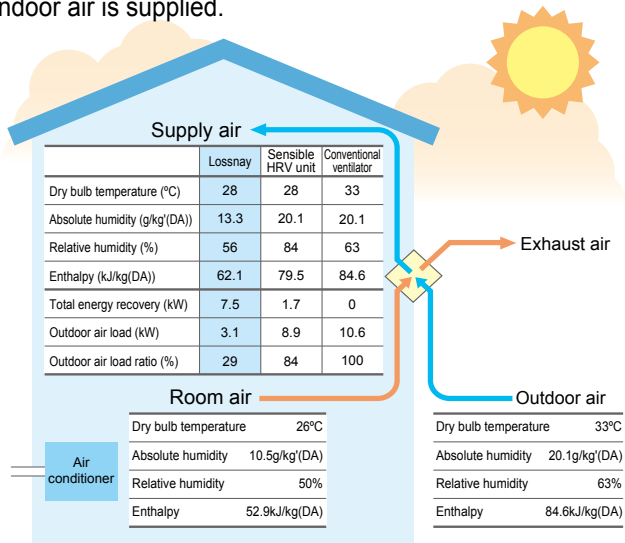

Heat recovery calculation

$$\text{Indoor supply-air temperature (°C)} = \text{Outdoor temperature (°C)} - \left(\text{Outdoor temperature (°C)} - \text{Indoor temperature (°C)} \right) \times \text{Temp recovery efficiency (\%)}$$

Calculation example : 28°C=33°C-(33°C-26°C)×72%

*The above applies to the case of LGH-100RVX (fan speed 4).

In winter

Air similar to the conditions of the heated (humidified) indoor air is supplied.

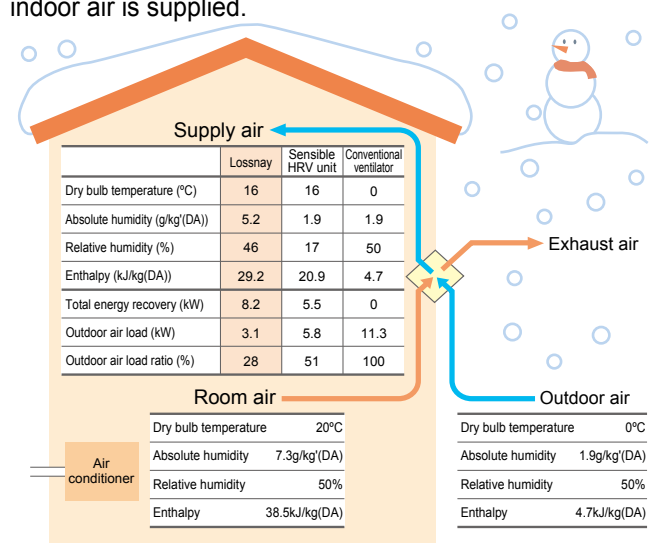

Heat recovery calculation

$$\text{Indoor supply-air temperature (°C)} = \text{Indoor temperature (°C)} - \left(\text{Outdoor temperature (°C)} - \text{Indoor temperature (°C)} \right) \times \text{Temp recovery efficiency (\%)} + \text{Outdoor temperature (°C)}$$

Calculation example : 16°C=(20°C-0°C)×80%+0°C

MITSUBISHI ELECTRIC Air Management :

Easy Installation

- Installable in tight ceiling spaces

Energy Efficiency

- Heat recovery ventilation
- Scheduled ventilation programs
- Contribute to EPBD
(Energy Performance of Buildings Directive)

Improve Indoor air quality

- Ventilation on demand
- Simultaneous air supply and exhaust

Air Management

CLEAN

Ventilation and clean, fresh air contribute to a healing living environment.

COMFO

Heat recovery ventilation operation assures a comfortable indoor environment.

MITSUBISHI ELECTRIC is New Solutions for



LGH-RVXT Series

for a healthier, more comfortable work place and home.



Solutions

COMFORTABLE

and low noise
environment.

ENERGY SAVING

A highly efficient EC motor operates at a lower energy consumption. Heat recovery ventilators also help to reduce the load on air conditioning systems.

better air management.



VL-220CZGV-E

LGH Series



Improved Air Volume Range

Wide range air volume

Unlike the air volume produced by previous models, in which there are the three settings of “High,” “Low,” and “Extra-low,” the new model is equipped with four fan speeds. In addition, each speed has a range setting of 25, 50, 75 and 100%, allowing much finer air volume control.

When used in combination with the CO₂ sensor or timer function, the air volume can be controlled according to conditions that realize better performance and reduce power consumption.

■ Previous model (LGH-RX_s series) characteristic curves

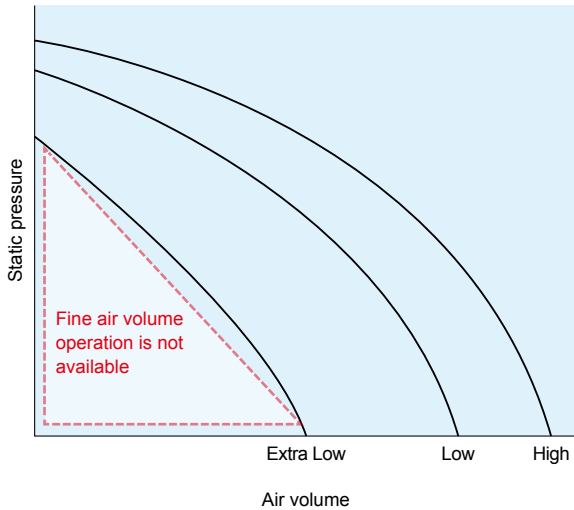

■ LGH-RVX/RVXT series model characteristic curves

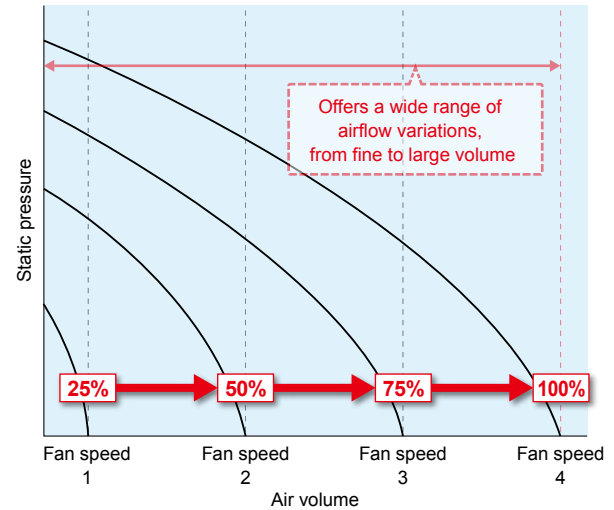

Air volume control by CO₂ sensor

An external CO₂ sensor can be connected directly to the Lossnay RVX/RVXT units allowing the fan speed to vary according to the CO₂ levels detected.

When the CO₂ concentration is low, the unit can operate at a lower air volume compared to previous models and this improves total heat exchange efficiency and contributes to energy saving.

Fan speed 4

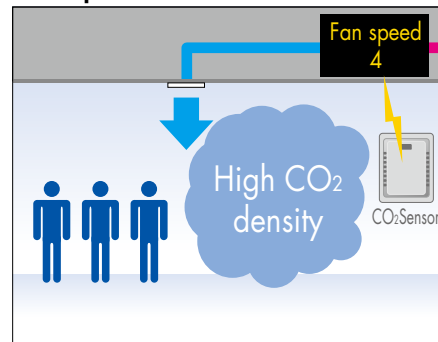

Fan speed 1

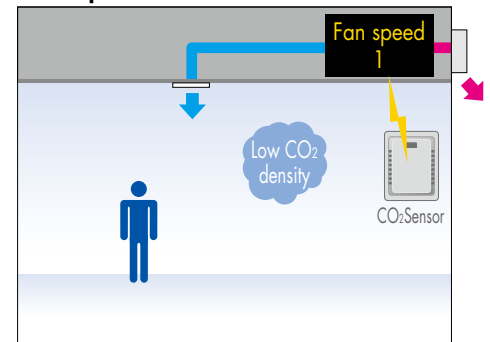

Weekly timer

The operation pattern for each day of the week, ON / OFF and air volume can be set using the weekly timer function (up to eight zones per day). Compared to previous models, much finer operation control contributes to enhanced energysaving operation. With a wider range of air volumes the Lossnay RVX/RVXT units enable optimised ventilation not just at different times of the day, but for different days of the week as well, enabling further energy savings.

LGH-RX_s series model

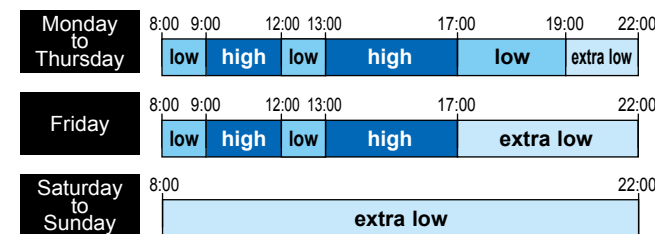

LGH-RVX/RVXT series model

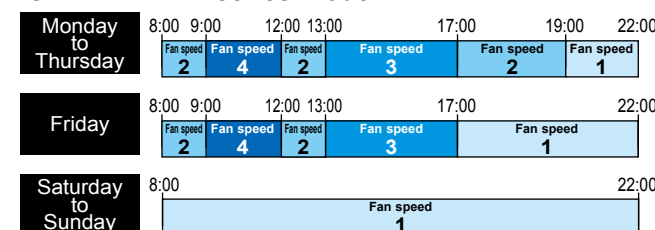

■ Total power consumption in a week

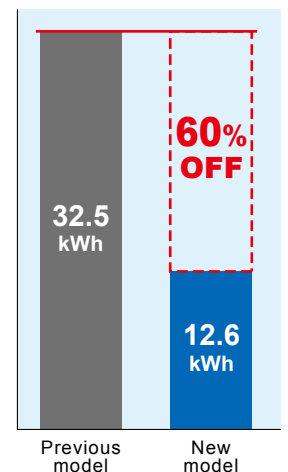

*Comparison of LGH-100RX_s-E and LGH-100RVX-E

Improved external static pressure

External static pressure has been improved compared to previous models. By increasing the external static pressure, highly flexible duct work becomes possible thus renewal from existing equipment is easy.

When the equipment layout is reviewed during renewal, even if new obstacles are found, installation can be smooth.

Often complicated installation under the roof can be handled flexibly!

Fan speed adjustment function

The default fan speed value can be adjusted slightly. Use the PZ-61DR-E remote controller to reset the speed.

- 1) Considering the total hours of Lossnay operation (filter clogging), the fan power can be adjusted automatically after a given period of time.
- 2) After the unit is installed, when if the air volume is slightly lower than the desired airflow, it is possible to make fine adjustments.

■ P-Q curve image

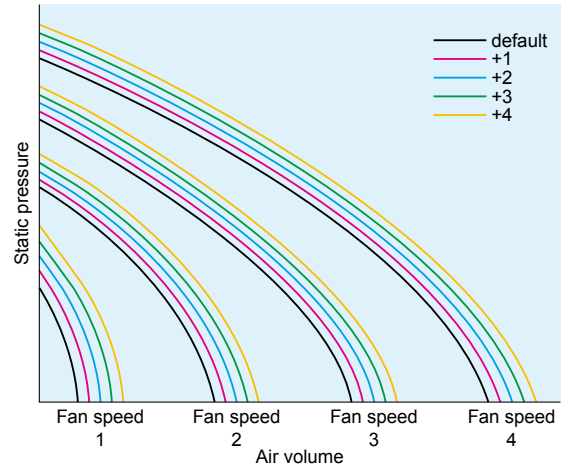

Improved Installation

Connect ducts in two different directions (OA, EA side)

Ducts can be connected in two different directions to the outdoor vents thanks to collars and aperture plates that can be interchangeably placed in two different positions. This flexibility allows for installations close to the surface of a wall and helps avoid cases where the stale air exhaust vent would be blocked by an obstruction of some kind. This makes both planning and installation that much simpler.

Standard installation	Installation with duct direction changed	
<p>A space is necessary to prevent the influx of rainwater.</p> <p>EA ↓ ↑ OA</p>	<p>Can be installed close to the surface of the wall.</p> <p>EA ↓ ↑ OA</p>	<p>Avoid installations where the stale air exhaust aperture would be blocked by lighting or air conditioning units.</p> <p>EA ↓ ↑ OA</p>
<p>Flange Plate</p>	<p>Changing the duct direction</p> <p>Exchangeable</p>	<p>Remove the flange (factory-standard direction) and the side panel plate and switch their placements. They are both equipped with screw stoppers making the switch extremely simple. The direction of the ducts can only be changed on the outside (OA and EA). The inside cannot be changed (SA and RA).</p>

OA/EA square duct (LGH-150 / 200RVX-E)

OA/EA is square duct. This simplifies installation and reduces total installation time.

Thin new series (LGH-RVXT-E)

The LGH-RVXT-E series have a large air volume of 1500 - 2500 CMH, but has a thin body @500mm. Installing the unit behind the ceiling is easy.

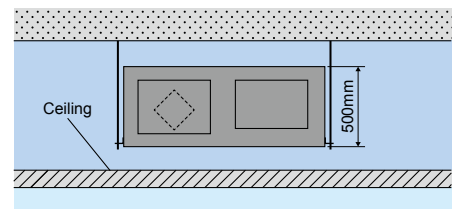

Further Energy Saving Features

Flexibility in setting Night purge and Auto ventilation have improved

Night purge

During the summer season, the Night Purge mode draws cooler outside air into the room at night. This energy conservation mode reduces the load when the air conditioning is started up the next morning.

With previous models, the unit is operated with only one condition that is set initially. With new models, it is possible to freely set* the night purge operation for the start conditions, air volume, and operation time and flexibly answer to the operating environment requests that vary with each customer.

* Settings can only be made using the PZ-61DR-E

Previous model

Night purge function operation time

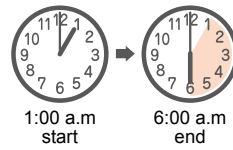

Start condition

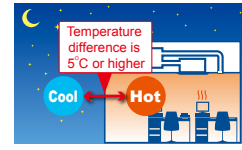

Fan speed

Start the operation at the same fan speed before stopping



New model

Operating time

Possible to set to any time

Start condition (inside-outside temperature difference)

Can be set to between 0°C and 7°C (1°C increments)

Fan speed

Select from Fan Speed 1 to 4

Ventilation mode switching

With operation from PZ-61DR-E, it is possible to select manual switching or automatic switching between "Lossnay ventilation (with heat exchange)" and "Bypass ventilation (without heat exchange)".

What is Lossnay ventilation?

Room air is discharged to outside via Lossnay core. Heat exchanged outside air is supplied to the room. In summer and winter, air conditioning energy can be recovered by Lossnay unit.

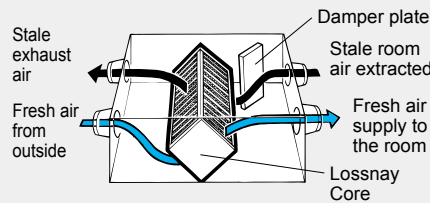

What is bypass ventilation?

Stare room air is discharged to outside without passing through the Lossnay core. In spring and fall when air conditioning is not necessary, the unit operates in bypass ventilation mode.

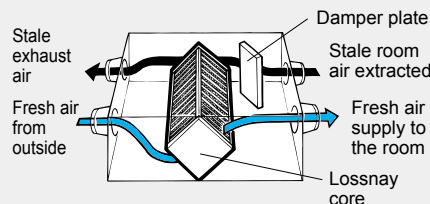

■ Bypass / Lossnay ventilation map in automatic ventilation mode

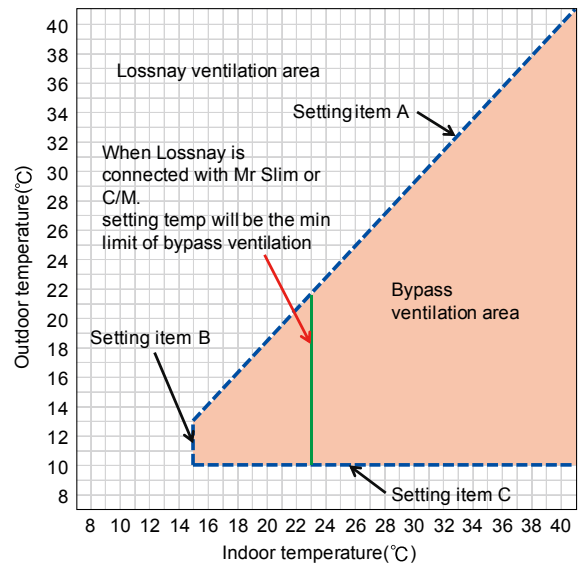

With the previous model, the auto ventilation mode is based on the initial setting condition; however, with the new model it becomes possible to set three setting points, as shown in the table on the right.

* Settings can only be made using the PZ-61DR-E

Improved control with a BMS system

Using a 0-10V signal from the building management system, the air volume of the Lossnay unit can be changed.

■ Connection example : BMS (Building Management System)

Input voltage [VDC]	Fan speed	Fan speed changing from remote controller
0 - 1.0	—	Available
1.5 - 2.5	1	Not available
3.5 - 4.5	2	Not available
5.5 - 7.0	3	Not available
8.5 - 10.0	4	Not available

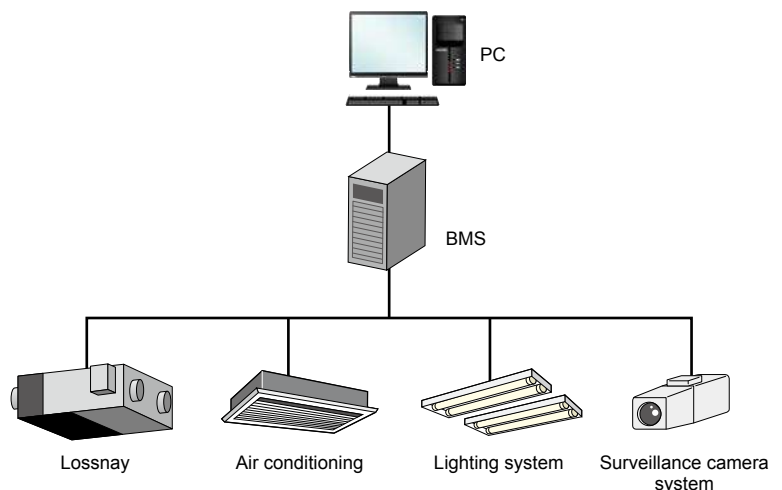

Control

The New Remote Controller PZ-61DR-E enables simple control setting

LGH Series

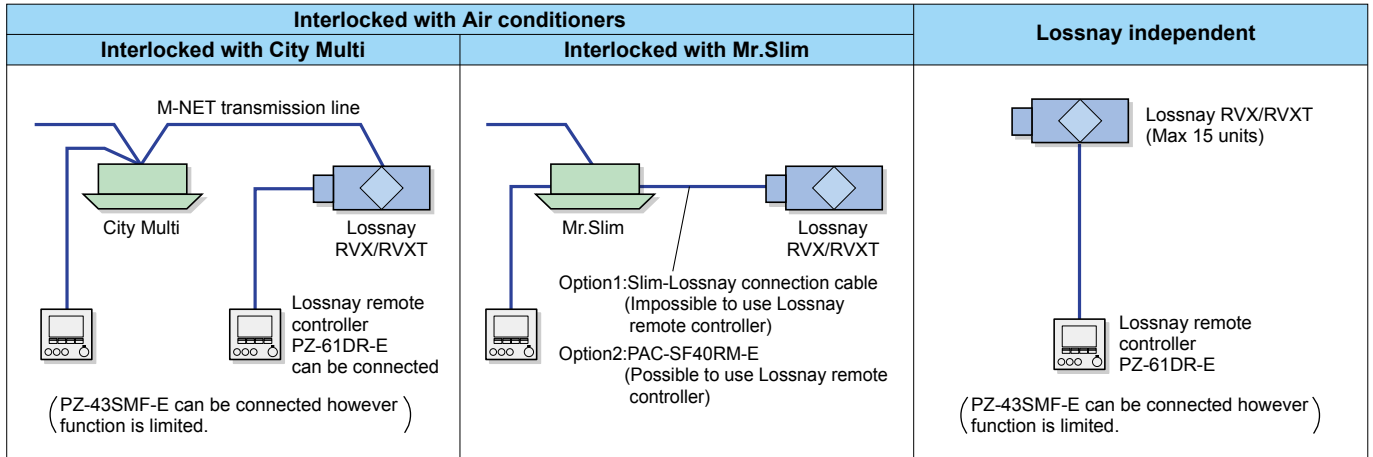

Centralised Controller System

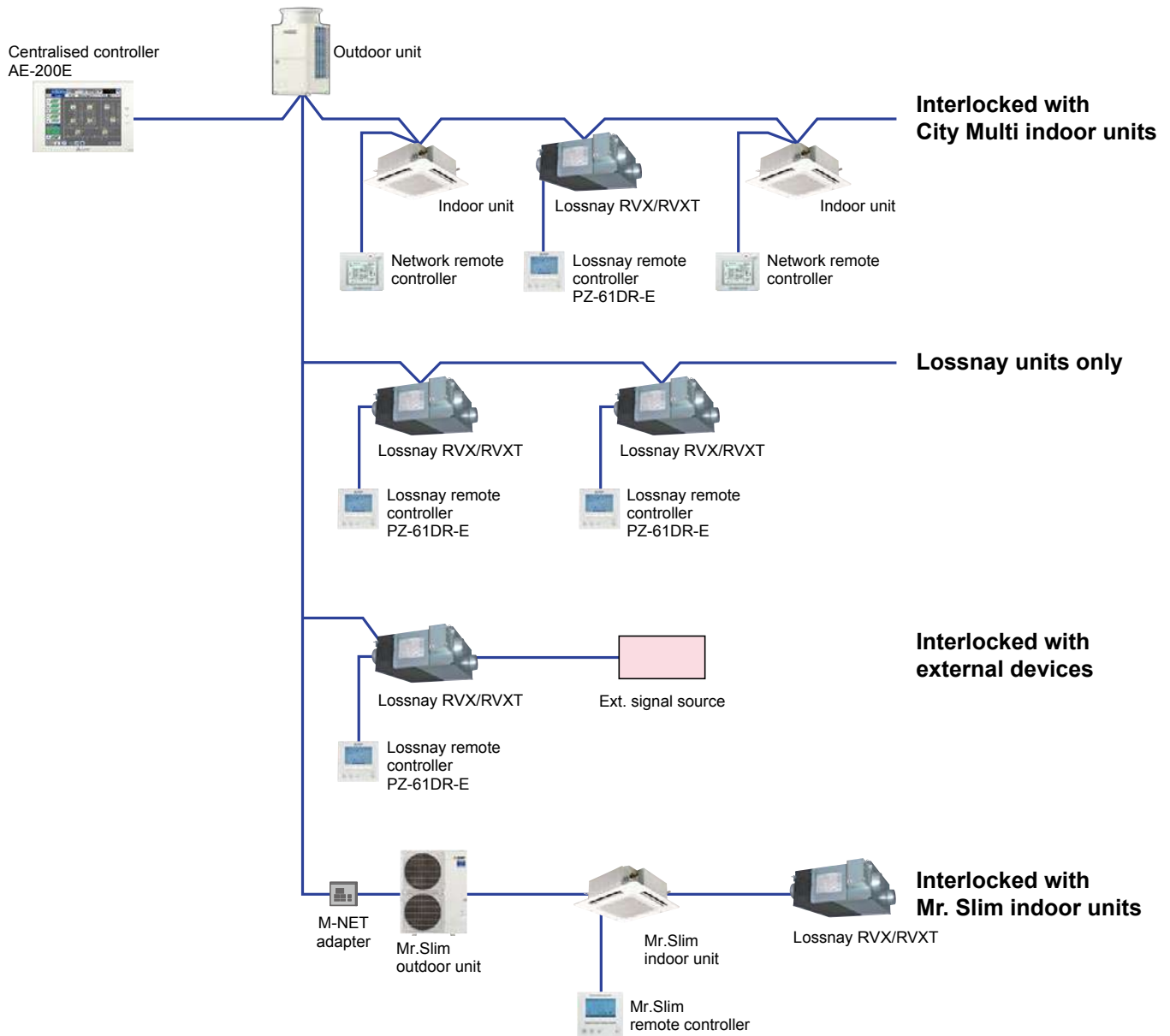

Features of New Centralised Controller "AE-200E"

In an easy and flexible manner, an optimum system can be established according to the scale of facilities.

- Implements control on up to 50 indoor units of air-conditioning equipment.
- By using three units of expansion controller "AE-50E", the centralized control is implemented for the maximum of 200 indoor units.
- Connection with PC allows implementation of control on more than 200 indoor units via Web browser.*1

*1. Please contact your local distributor for when the feature is supported.

System structure

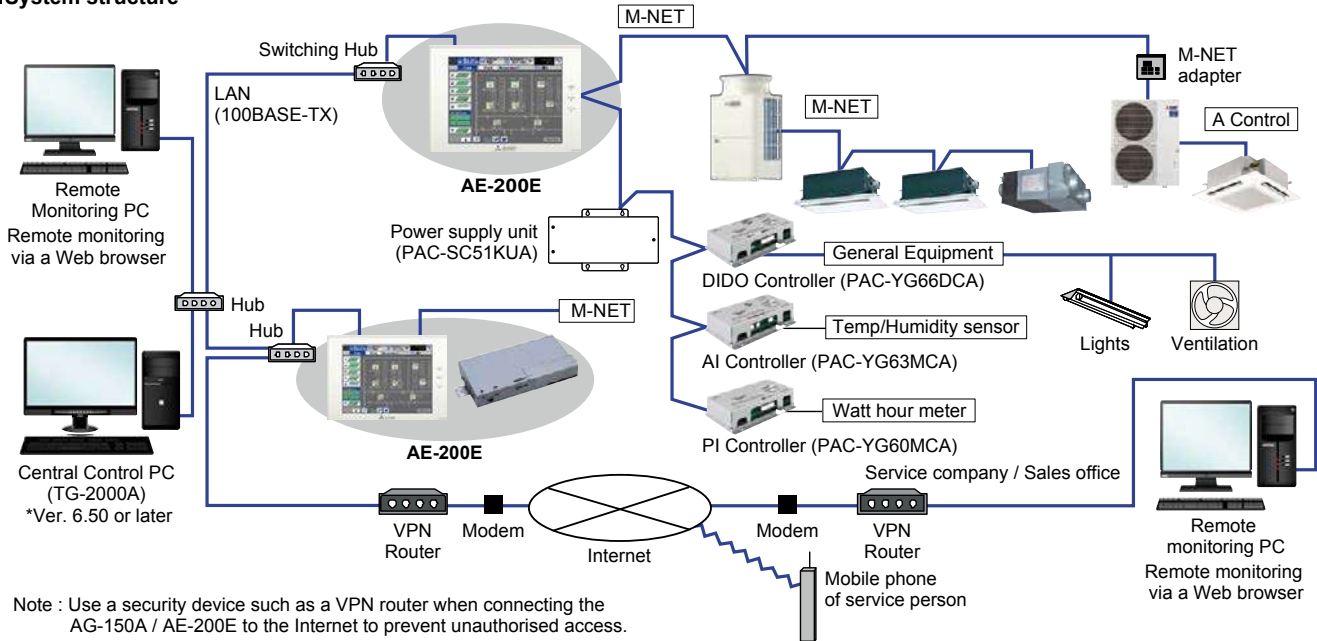

Note : Use a security device such as a VPN router when connecting the AG-150A / AE-200E to the Internet to prevent unauthorised access.

Functions

□ : Each unit ○ : Each group ● : Each block △ : Each floor ◎ : Collective × : Not available

Item	Description	Operations	Display
Controllable number of unit	Up to 50 units/50 groups		
ON/OFF	ON and OFF operation for the air conditioning units and general equipment. (To operate general equipment, PAC-YG66DCA is required.)	○○△●	○○◎
Operation mode	Switches between several operation modes depending on the air conditioning unit. Air conditioning unit : Cool/Dry/Auto(*)/Fan/Heat LOSSNAY unit : Heat Recovery/Bypass/Auto CAHV, CRHV, Air To Water (PWFY) units : Heating, Heating ECO, Hot Water, Anti-freeze, Cooling(**) * Auto mode is for CITY MULTI R2 and WR2 series only. ** Only PWFY	○○△●	○
Temperature setting	Cool/Dry : 19°C (67°F) -35°C (95°F) [14°C (57°F) -30°C (87°F)] Heat : 4.5°C (40°F) -28°C (83°F) [17°C (63°F) -28°C (83°F)] Auto : 19°C (67°F) -28°C (83°F) [17°C (63°F) -28°C (83°F)] The range of temperature depends on the air conditioning unit. [] in case of using middle-temperature on PDFY, PEFY-VML/VMR/VMS/VMH-by setting DipSW7-1 to ON. Yet, PEFY-P-VMH-E-F is excluded.	○○△●	○
Fan speed setting	Models with 4 air flow speed settings : Hi/Mid-2/Mid-1/Low Models with 3 air flow speed settings : Hi/Mid/Low Models with 2 air flow speed settings : Hi/Low Fan speed setting (including Auto) varies depending on the model.	○○△●	○
Air flow direction setting	Air flow direction angles, 4-angles or 5-angles Swing, Auto (Louver cannot be set)	○○△●	○
Schedule operation	Weekly schedule can be set by groups based on daily operation pattern.	○○△●	○
Permit/prohibit local operation	Individually prohibits operation of each local remote controller function. (ON/OFF, Operation mode, Set temperature, Filter sign reset, Air Direction*, Fan Speed*, Timer*) * This function depends on the model.	○○△●	○
Indoor unit intake temperature	Measures the intake temperature of the indoor unit only when the indoor unit is operating.	×	○
Error	When an error is currently occurring on an air conditioning unit, the afflicted unit and the error code are displayed.	×	□◎
Test run	This operates air conditioning units in test run mode.	○○△●	○
Ventilation interlock	The ventilation unit (LOSSNAY) is able to automatically start its operation when operation of the interlocked indoor unit starts.	○○△●	○
External input/output	By using optional external input/output adapter (PAC-YG10HA-E) you can set and monitor the following. Input : By level signal : "Batch ON/OFF", "Batch emergency stop" By pulse signal : "Batch ON/OFF", "Enable/disable local remote controller" Output : "ON/OFF", "Error/Normal"	◎	◎
Energy Management	Bar Graph : Indoor unit Electric Energy, FAN operation time, Thermo-ON time (TOTAL, Cooling, Heating) can be displayed hourly, daily and monthly. Line Graph : Outdoor temp., Room temp., Set temp. (Heating, Cooling) Input from PAC-YG63MCA and temp. From AHC.	×	□○●
Advanced HVAC Controller (AHC)	The status of AHC can only be monitored.	×	○
Smart ME controller	The status of sensor on this controller can be monitored.	×	○
Smartphone/Tablet	The specified Web browser on iOS and Android OS can monitor and operate AE-200E. *2	○	○
New Web design	The web screen design is renewed for user friendly interface. *2	○○△●	○
Initial setting software	The initial setting can be configured without the connection of AE-200E. *2	×	×
Apportionment of power consumption	Apportionment of power consumption can be calculated on AE-200 without TG-2000A. *2	●	□●
BACnet® communication	ANSI/ASHRAE 135-2010 (ISO16484-5) is supported and approved by the BTL. *2	○	×

*2 Please contact your local distributor for when the feature is supported.

Specifications

LGH-15 to 100RVX-E



LGH-150 and 200RVX-E



LGH-150 to 250RVXT-E



LGH-15/25RVX-E

Model	LGH-15RVX-E								LGH-25RVX-E							
Electrical power supply	220-240V/50Hz, 220V/60Hz								220-240V/50Hz, 220V/60Hz							
Ventilation mode	Heat recovery mode				Bypass mode				Heat recovery mode				Bypass mode			
Fan speed	SP4	SP3	SP2	SP1	SP4	SP3	SP2	SP1	SP4	SP3	SP2	SP1	SP4	SP3	SP2	SP1
Running current (A)	0.40	0.24	0.15	0.10	0.41	0.25	0.15	0.10	0.48	0.28	0.16	0.10	0.48	0.29	0.16	0.11
Input power (W)	49	28	14	7	52	28	14	8	62	33	16	7.5	63	35	17	9
Air volume	(m ³ /h)															
	(L/s)															
External static pressure (Pa)	95	54	24	6	95	54	24	6	85	48	21	5	85	48	21	5
Temperature exchange efficiency (%)	80.0	81.0	83.0	84.0	—	—	—	—	79.0	80.0	82.0	86.0	—	—	—	—
Enthalpy exchange efficiency (%)	Heating															
	Cooling															
Noise (dB) (Measured at 1.5m under the center of unit in an anechoic chamber)	28.0	24.0	19.0	17.0	29.0	24.0	19.0	18.0	27.0	22.0	20.0	17.0	27.5	23.0	20.0	17.0
Weight (kg)	20								23							
Specific energy consumption class	A								A							

*The Air outlets noise (45° angle, 1.5 meters in front of the unit) is about 13dB(LGH-15RVX-E) / 15dB(LGH-25RVX-E) greater than the indicated value. (at Fan speed 4)

*The running current, the input power, the efficiency and the noise are based on the rating air volume, and 230V/50Hz.

*For the specification at the other frequency contact your dealer.

*Figures in the chart is measured according to Japan Industrial Standard (JIS B 8628). Characteristic Curves are measured by chamber method.

Characteristic Curve of the LGH-15RVX-E

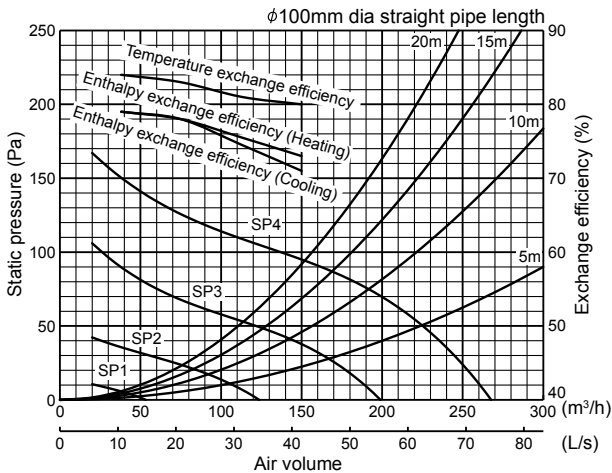

Characteristic Curve of the LGH-25RVX-E

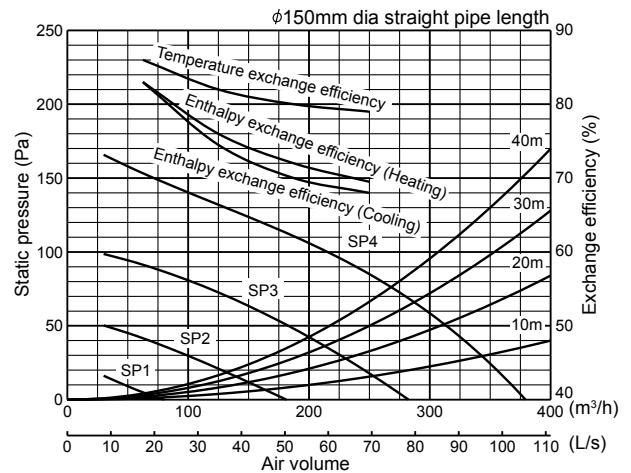

Dimensions of the LGH-15RVX-E

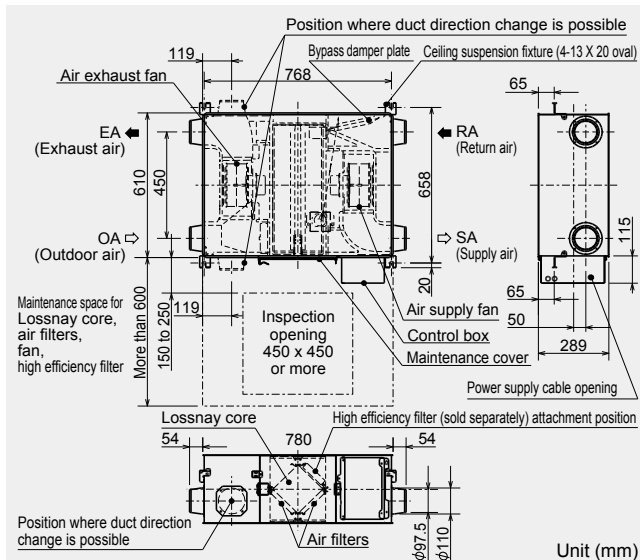

Dimensions of the LGH-25RVX-E

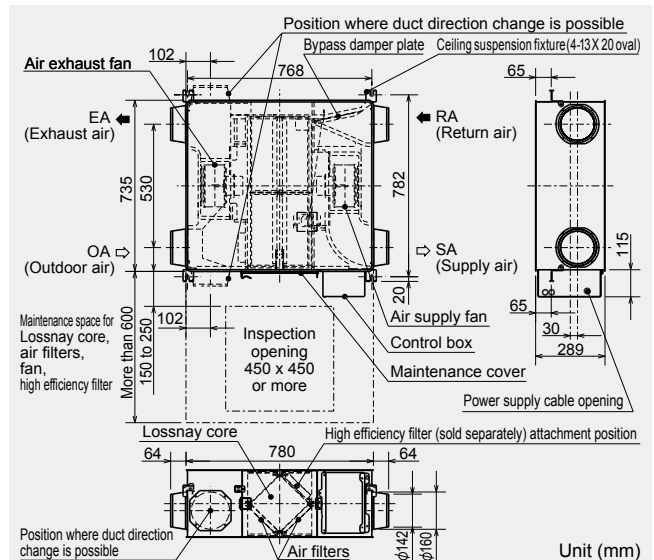

LGH-35/50RVX-E

Model		LGH-35RVX-E								LGH-50RVX-E									
Electrical power supply		220-240V/50Hz, 220V/60Hz								220-240V/50Hz, 220V/60Hz									
Ventilation mode		Heat recovery mode				Bypass mode				Heat recovery mode				Bypass mode					
Fan speed		SP4	SP3	SP2	SP1	SP4	SP3	SP2	SP1	SP4	SP3	SP2	SP1	SP4	SP3	SP2	SP1		
Running current (A)		0.98	0.54	0.26	0.12	0.98	0.56	0.28	0.13	1.15	0.59	0.26	0.13	1.15	0.59	0.27	0.13		
Input power (W)		140	70	31	11	145	72	35	13	165	78	32	12	173	81	35	14		
Air volume		(m ³ /h)		350	263	175	88	350	263	175	88	500	375	250	125	500	375	250	125
		(L/s)		97	73	49	24	97	73	49	24	139	104	69	35	139	104	69	35
External static pressure (Pa)		160	90	40	10	160	90	40	10	120	68	30	8	120	68	30	8		
Temperature exchange efficiency (%)		80.0	82.5	86.0	88.5	—	—	—	—	78.0	81.0	83.5	87.0	—	—	—	—		
Enthalpy exchange efficiency (%)		Heating		71.5	74.0	78.5	83.5	—	—	—	—	69.0	71.0	75.0	82.5	—	—	—	—
		Cooling		71.0	73.0	78.0	82.0	—	—	—	—	66.5	68.0	72.5	82.0	—	—	—	—
Noise (dB) (Measured at 1.5m under the center of unit in an anechoic chamber)		32.0	28.0	20.0	17.0	32.5	28.0	20.0	18.0	34.0	28.0	19.0	18.0	35.0	29.0	20.0	18.0		
Weight (kg)		30								33									

*The Air outlets noise (45° angle, 1.5 meters in front of the unit) is about 12dB(LGH-35RVX-E) / 18dB(LGH-50RVX-E) greater than the indicated value. (at Fan speed 4)

*The running current, the input power, the efficiency and the noise are based on the rating air volume, and 230V/50Hz.

*For the specification at the other frequency contact your dealer.

*Figures in the chart is measured according to Japan Industrial Standard (JIS B 8628). Characteristic Curves are measured by chamber method.

Characteristic Curve of the LGH-35RVX-E

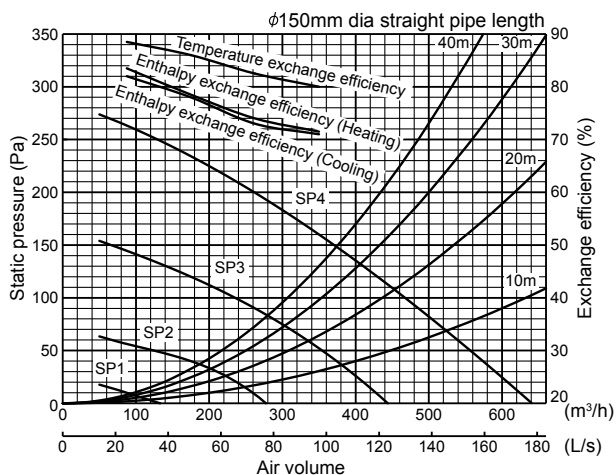

Characteristic Curve of the LGH-50RVX-E

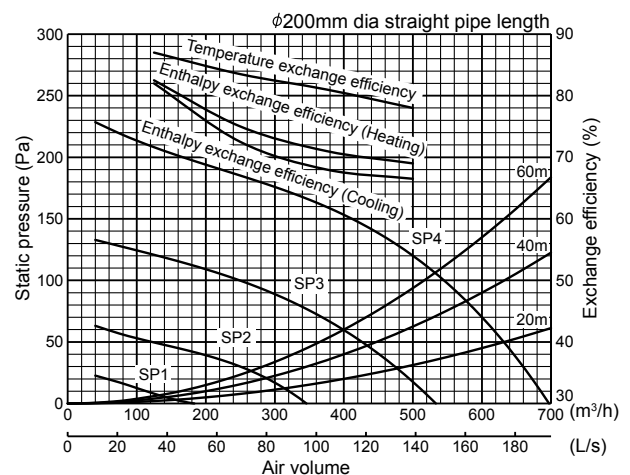

Dimensions of the LGH-35RVX-E

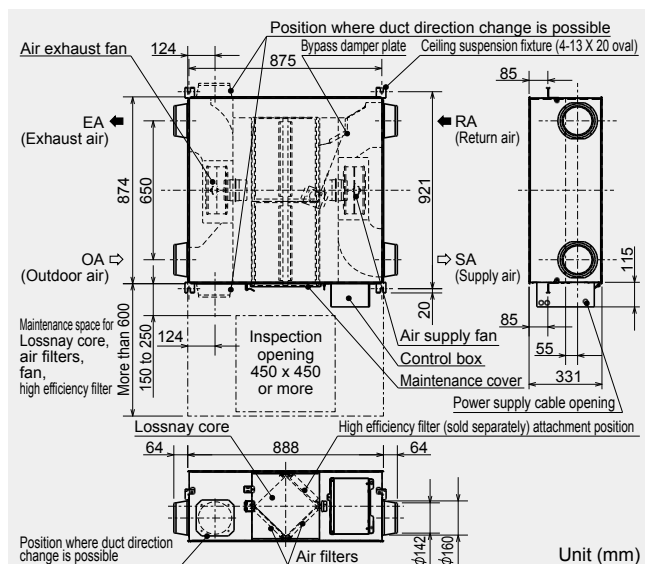

Dimensions of the LGH-50RVX-E

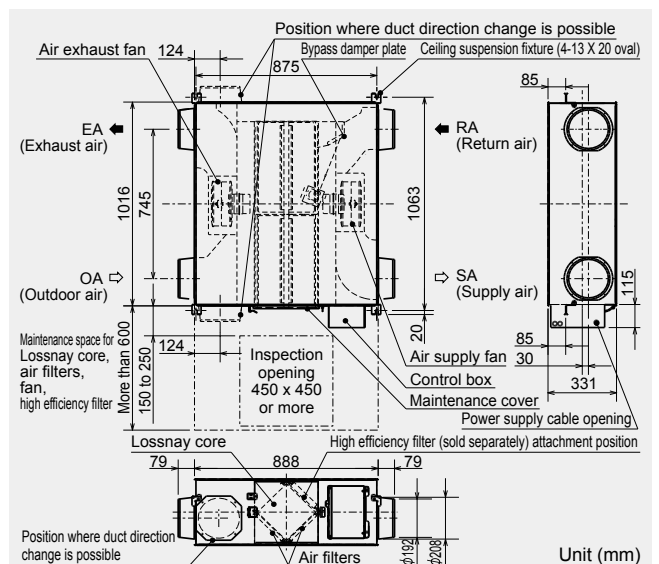

LGH-65/80RVX-E

Model		LGH-65RVX-E								LGH-80RVX-E									
Electrical power supply		220-240V/50Hz, 220V/60Hz								220-240V/50Hz, 220V/60Hz									
Ventilation mode		Heat recovery mode				Bypass mode				Heat recovery mode				Bypass mode					
Fan speed		SP4	SP3	SP2	SP1	SP4	SP3	SP2	SP1	SP4	SP3	SP2	SP1	SP4	SP3	SP2	SP1		
Running current (A)		1.65	0.90	0.39	0.15	1.72	0.86	0.38	0.16	1.82	0.83	0.36	0.15	1.97	0.86	0.40	0.15		
Input power (W)		252	131	49	15	262	131	47	17	335	151	60	18	340	151	64	20		
Air volume		(m ³ /h)		650	488	325	163	650	488	325	163	800	600	400	200	800	600	400	200
		(L/s)		181	135	90	45	181	135	90	45	222	167	111	56	222	167	111	56
External static pressure (Pa)		120	68	30	8	120	68	30	8	150	85	38	10	150	85	38	10		
Temperature exchange efficiency (%)		77.0	81.0	84.0	86.0	—	—	—	—	79.0	82.5	84.0	85.0	—	—	—	—		
Enthalpy exchange efficiency (%)		Heating		68.5	71.0	76.0	82.0	—	—	—	—	71.0	73.5	78.0	81.0	—	—	—	—
		Cooling		66.0	69.5	74.0	81.0	—	—	—	—	70.0	72.5	78.0	81.0	—	—	—	—
Noise (dB) (Measured at 1.5m under the center of unit in an anechoic chamber)		34.5	29.0	22.0	18.0	35.5	29.0	22.0	18.0	34.5	30.0	23.0	18.0	36.0	30.0	23.0	18.0		
Weight (kg)		38								48									

*The Air outlets noise (45° angle, 1.5 meters in front of the unit) is about 16dB(LGH-65RVX-E) / 24dB(LGH-80RVX-E) greater than the indicated value. (at Fan speed 4)
 *The running current, the input power, the efficiency and the noise are based on the rating air volume, and 230V/50Hz.
 *For the specification at the other frequency contact your dealer.
 *Use this unit with static pressure 240Pa or less at Fan speed 4. Otherwise the noise level might be large. (Only LGH-80RVX-E)
 *Figures in the chart is measured according to Japan Industrial Standard (JIS B 8628). Characteristic Curves are measured by chamber method.

Characteristic Curve of the LGH-65RVX-E

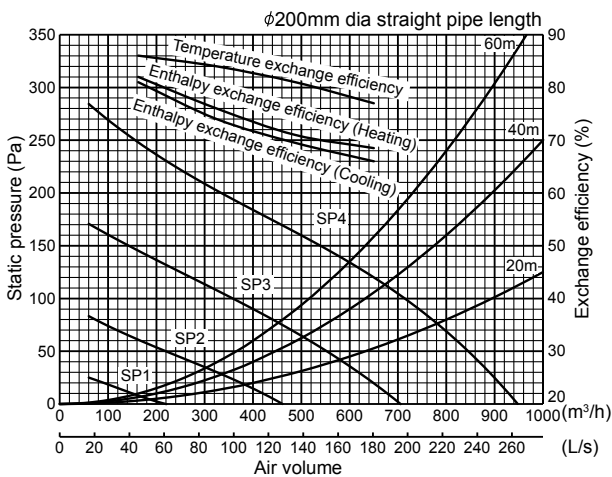

Characteristic Curve of the LGH-80RVX-E

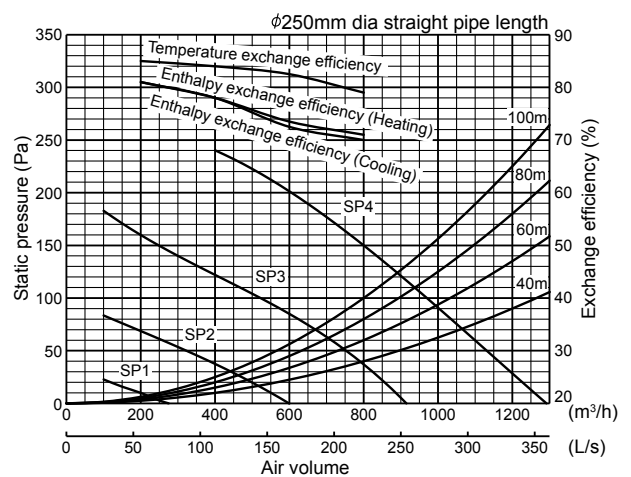

Dimensions of the LGH-65RVX-E

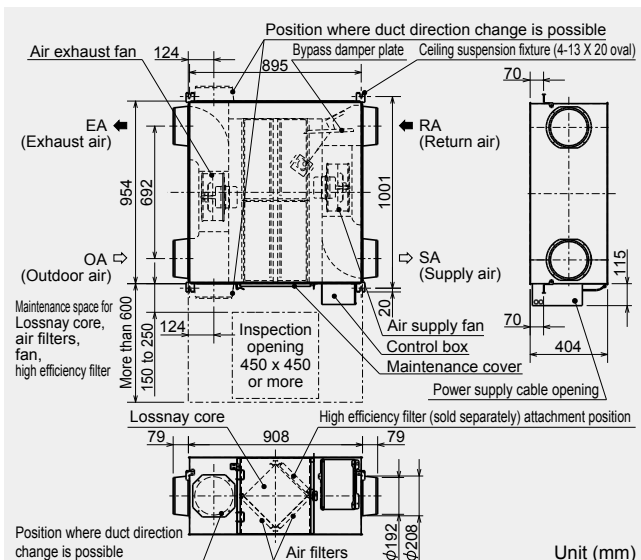

Dimensions of the LGH-80RVX-E

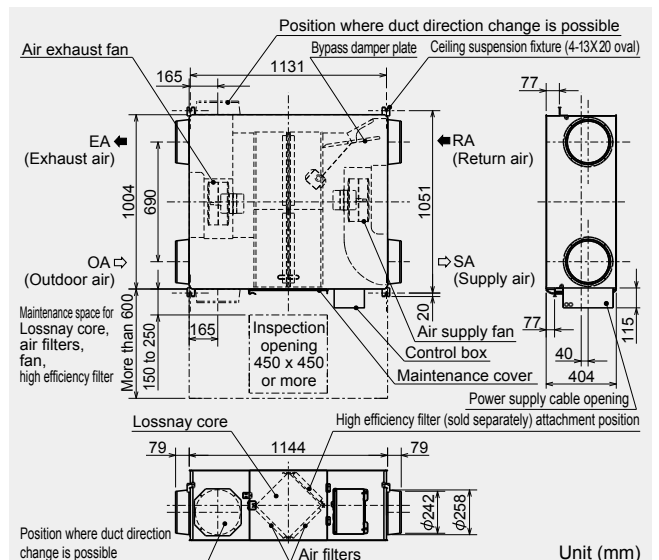

LGH-100/150RVX-E

Model	LGH-100RVX-E								LGH-150RVX-E								
Electrical power supply	220-240V/50Hz, 220V/60Hz								220-240V/50Hz, 220V/60Hz								
Ventilation mode	Heat recovery mode				Bypass mode				Heat recovery mode				Bypass mode				
Fan speed	SP4	SP3	SP2	SP1	SP4	SP3	SP2	SP1	SP4	SP3	SP2	SP1	SP4	SP3	SP2	SP1	
Running current (A)	2.50	1.20	0.50	0.17	2.50	1.20	0.51	0.19	3.71	1.75	0.70	0.29	3.85	1.78	0.78	0.30	
Input power (W)	420	200	75	21	420	200	75	23	670	311	123	38	698	311	124	44	
Air volume	(m³/h)	1000	750	500	250	1000	750	500	250	1500	1125	750	375	1500	1125	750	375
	(L/s)	278	208	139	69	278	208	139	69	417	313	208	104	417	313	208	104
External static pressure (Pa)	170	96	43	11	170	96	43	11	175	98	44	11	175	98	44	11	
Temperature exchange efficiency (%)	80.0	83.0	86.5	89.5	—	—	—	—	80.0	82.5	84.0	85.0	—	—	—	—	
Enthalpy exchange efficiency (%)	Heating	72.5	74.0	78.0	87.0	—	—	—	—	72.0	73.5	78.0	81.0	—	—	—	—
	Cooling	71.0	73.0	77.0	85.5	—	—	—	—	70.5	72.5	78.0	81.0	—	—	—	—
Noise (dB) (Measured at 1.5m under the center of unit in an anechoic chamber)	37.0	31.0	23.0	18.0	38.0	32.0	24.0	18.0	39.0	32.0	24.0	18.0	40.5	33.0	26.0	18.0	
Weight (kg)	54								98								

*The Air outlets noise (45° angle, 1.5 meters in front of the unit) is about 21dB(LGH-100RVX-E) / 22dB(LGH-150RVX-E) greater than the indicated value. (at Fan speed 4)

*The running current, the input power, the efficiency and the noise are based on the rating air volume, and 230V/50Hz.

*For the specification at the other frequency contact your dealer.

*Use this unit between static pressure 60Pa and 240Pa at Fan speed 4. Otherwise the motor protection may work and reduce its output or the noise level might be larger. (Only LGH-100RVX-E)

*Use this unit with static pressure 250Pa or less at Fan speed 4. Otherwise the noise level might be larger. (Only LGH-150RVX-E)

*Figures in the chart is measured according to Japan Industrial Standard (JIS B 8628). Characteristic Curves are measured by chamber method.

Characteristic Curve of the LGH-100RVX-E

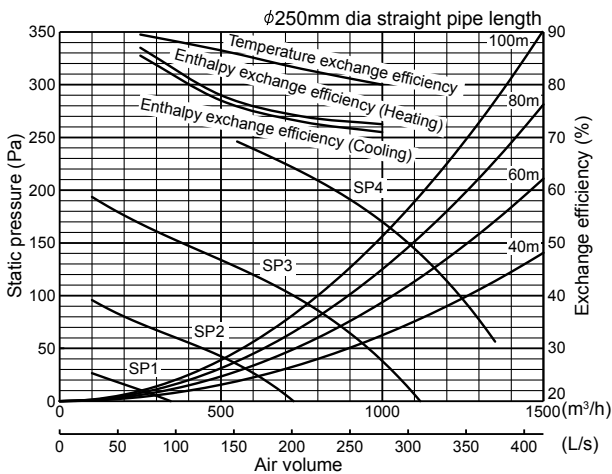

Characteristic Curve of the LGH-150RVX-E

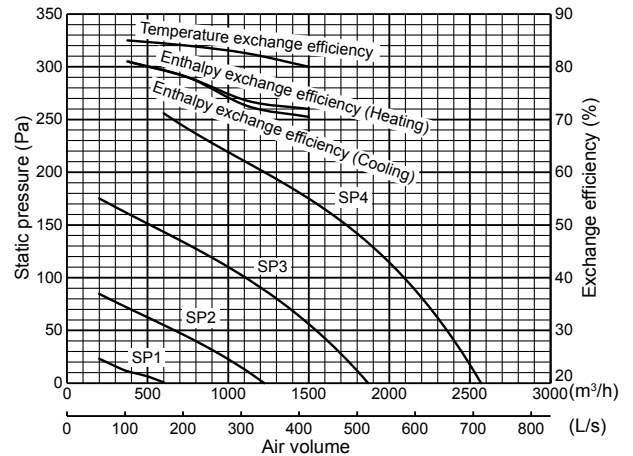

Dimensions of the LGH-100RVX-E

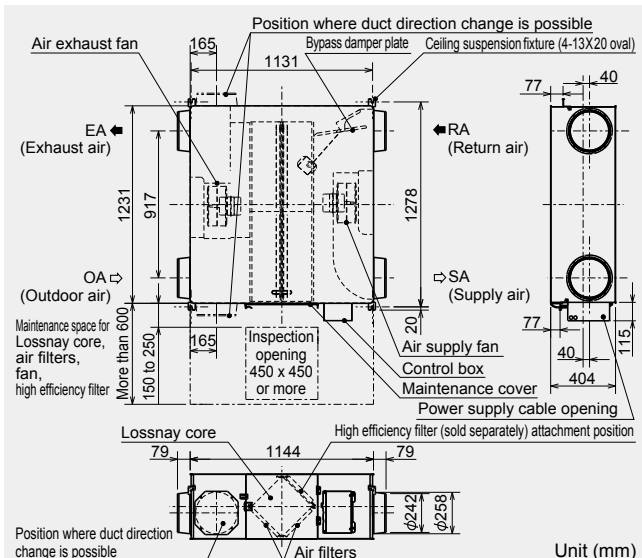

Dimensions of the LGH-150RVX-E

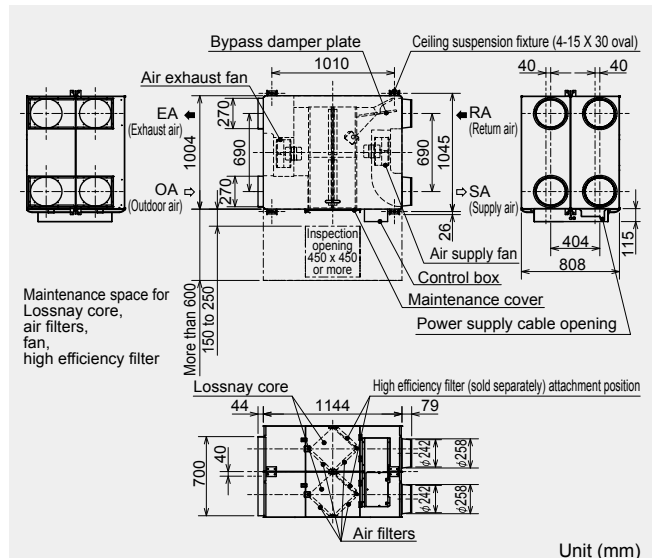

LGH-200RVX-E

Model		LGH-200RVX-E								
Electrical power supply		220-240V/50Hz, 220V/60Hz								
Ventilation mode		Heat recovery mode				Bypass mode				
Fan speed		SP4	SP3	SP2	SP1	SP4	SP3	SP2	SP1	
Running current (A)		4.88	2.20	0.88	0.33	4.54	2.06	0.87	0.35	
Input power (W)		850	400	153	42	853	372	150	49	
Air volume		(m ³ /h)	2000	1500	1000	500	2000	1500	1000	500
		(L/s)	556	417	278	139	556	417	278	139
External static pressure (Pa)		150	84	38	10	150	84	38	10	
Temperature exchange efficiency (%)		80.0	83.0	86.5	89.5	—	—	—	—	
Enthalpy exchange efficiency (%)		Heating	72.5	74.0	78.0	87.0	—	—	—	
		Cooling	71.0	73.0	77.0	85.5	—	—	—	
Noise (dB) (Measured at 1.5m under the center of unit in an anechoic chamber)		40.0	36.0	28.0	18.0	41.0	36.0	27.0	19.0	
Weight (kg)		110								

*The Air outlets noise (45 angle, 1.5meters in front of the unit) is about 21dB greater than the indicated value. (at Fan speed 4)
 *The running current, the input power, the efficiency and the noise are based on the rating air volume, and 230V/50Hz.
 *For the specification at the other frequency contact your dealer.
 *Use this unit between static pressure 50Pa and 220Pa at Fan speed 4. Otherwise the motor protection may work and reduce its output or the noise level might be large.
 *Figures in the chart is measured according to Japan Industrial Standard (JIS B 8628). Characteristic Curves are measured by chamber method.

Characteristic Curve

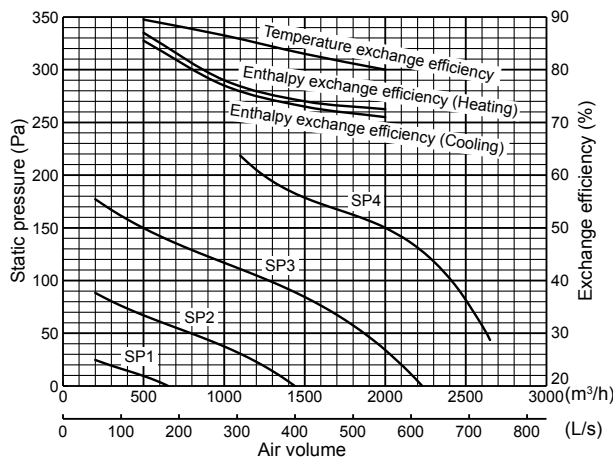

Dimensions

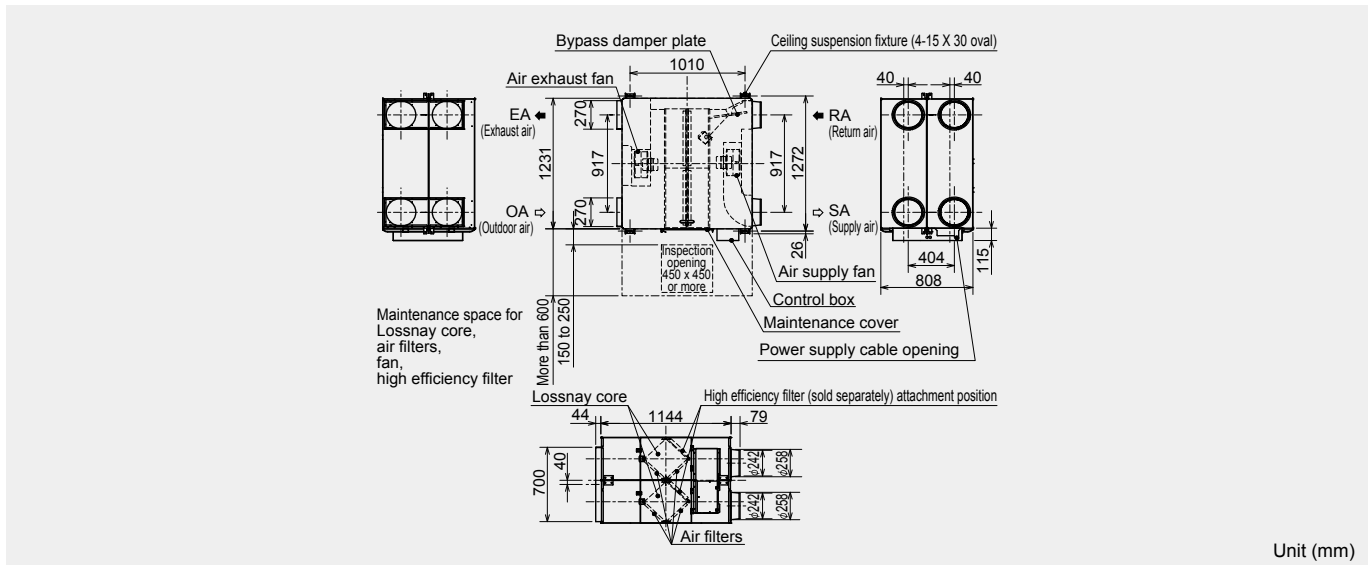

• Certain ratings and specifications may change due to product improvements or modifications. • Refer to the product manuals for safety precautions.

LGH-150/200RVXT-E

Model		LGH-150RVXT-E								LGH-200RVXT-E									
Electrical power supply		220-240V/50Hz, 220V/60Hz								220-240V/50Hz, 220V/60Hz									
Ventilation mode		Heat recovery mode				Bypass mode				Heat recovery mode				Bypass mode					
Fan speed		SP4	SP3	SP2	SP1	SP4	SP3	SP2	SP1	SP4	SP3	SP2	SP1	SP4	SP3	SP2	SP1		
Running current (A)		4.30	2.40	1.10	0.36	3.40	1.80	0.77	0.31	5.40	2.70	1.10	0.39	5.00	2.20	0.85	0.34		
Input power (W)		792	421	176	48	625	334	134	37	1000	494	197	56	916	407	150	45		
Air volume		(m ³ /h)		1500	1125	750	375	1500	1125	750	375	2000	1500	1000	500	2000	1500	1000	500
		(L/s)		417	313	208	104	417	313	208	104	556	417	278	139	556	417	278	139
External static pressure (Pa)		Supply		175	98	44	11	175	98	44	11	175	98	44	11	175	98	44	11
		Return		100	56	25	6	100	56	25	6	100	56	25	6	100	56	25	6
Temperature exchange efficiency (%)		80.0	80.5	81.0	81.5	—	—	—	—	80.0	81.0	82.5	84.0	—	—	—	—		
Enthalpy exchange efficiency (%)		Heating		70.0	71.0	73.0	75.0	—	—	—	—	72.5	73.5	77.0	83.0	—	—	—	—
		Cooling		69.0	70.0	72.0	74.0	—	—	—	—	70.0	71.0	74.5	80.5	—	—	—	—
Noise (dB)		39.5	35.5	29.5	22.0	39.0	33.0	26.5	20.5	39.5	35.5	28.0	22.0	40.5	34.5	27.0	20.5		
Weight (kg)		156								159									

*The running current, the input power, the efficiency and the noise are based on the rating air volume, and 230V/50Hz.
 *For the specification at the other frequency contact your dealer.
 *Figures in the chart is measured according to Japan Industrial Standard (JIS B 8628). Characteristic Curves are measured by chamber method.

Characteristic Curve of the LGH-150RVXT-E

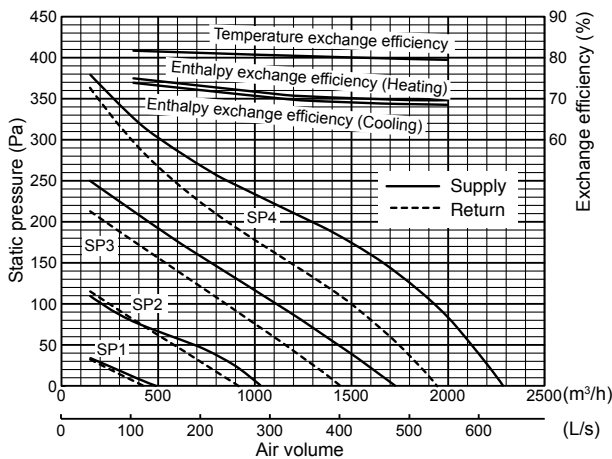

Characteristic Curve of the LGH-200RVXT-E

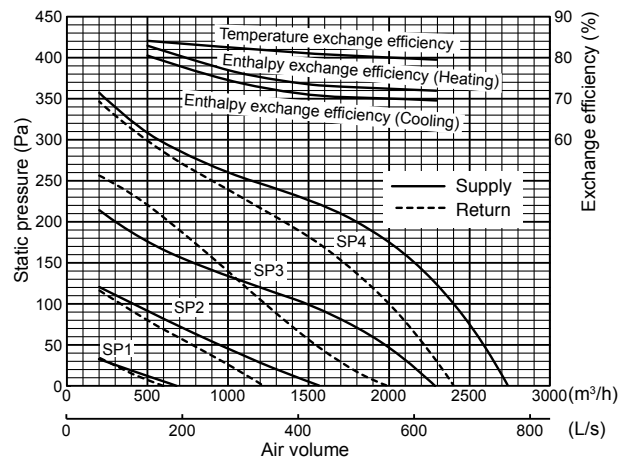

Dimensions of the LGH-150RVXT-E

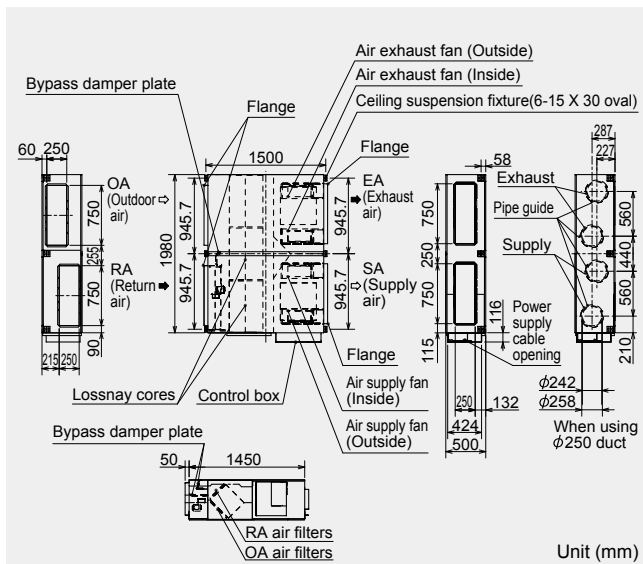

Dimensions of the LGH-200RVXT-E

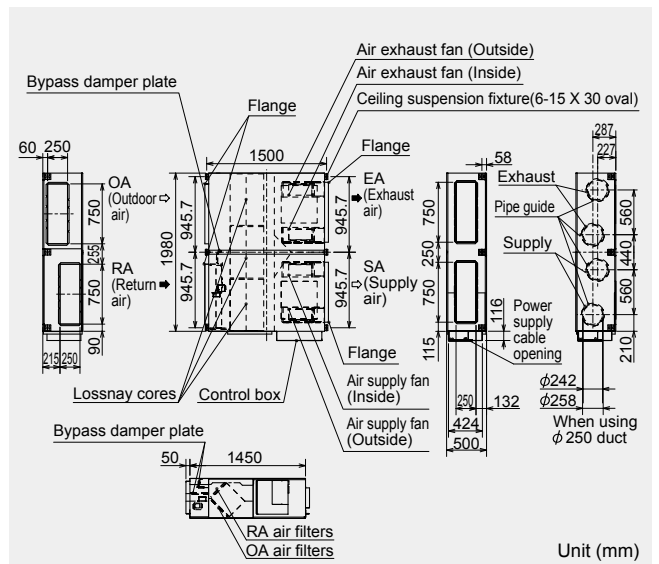

LGH-250RVXT-E

Model		LGH-250RVXT-E								
Electrical power supply		220-240V/50Hz, 220V/60Hz								
Ventilation mode		Heat recovery mode				Bypass mode				
Fan speed		SP4	SP3	SP2	SP1	SP4	SP3	SP2	SP1	
Running current (A)		7.60	3.60	1.40	0.57	6.90	3.10	1.30	0.49	
Input power (W)		1446	687	244	82	1298	587	212	69	
Air volume		(m ³ /h)	2500	1875	1250	625	2500	1875	1250	625
		(L/s)	694	521	347	174	694	521	347	174
External static pressure (Pa)		Supply	175	98	44	11	175	98	44	11
		Return	100	56	25	6	100	56	25	6
Temperature exchange efficiency (%)		77.0	79.0	80.5	82.5	—	—	—	—	
Enthalpy exchange efficiency (%)		Heating	68.0	71.5	74.0	79.0	—	—	—	—
		Cooling	65.5	69.0	71.5	76.5	—	—	—	—
Noise (dB)		43.0	39.0	32.0	24.0	44.0	38.5	31.0	22.5	
Weight (kg)		198								

*The running current, the input power, the efficiency and the noise are based on the rating air volume, and 230V/50Hz.
 *For the specification at the other frequency contact your dealer.
 *Figures in the chart is measured according to Japan Industrial Standard (JIS B 8628). Characteristic Curves are measured by chamber method.

Characteristic Curve

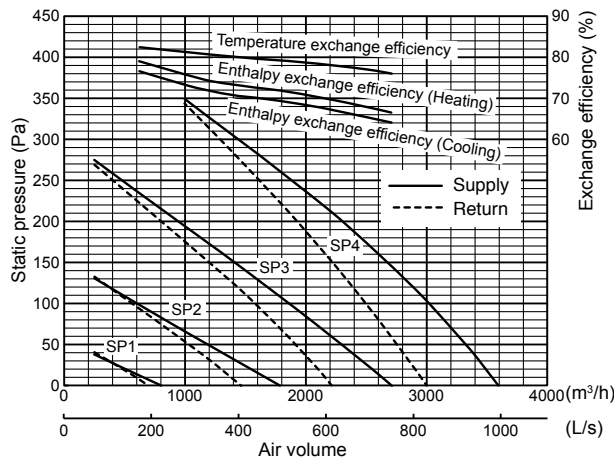

Dimensions

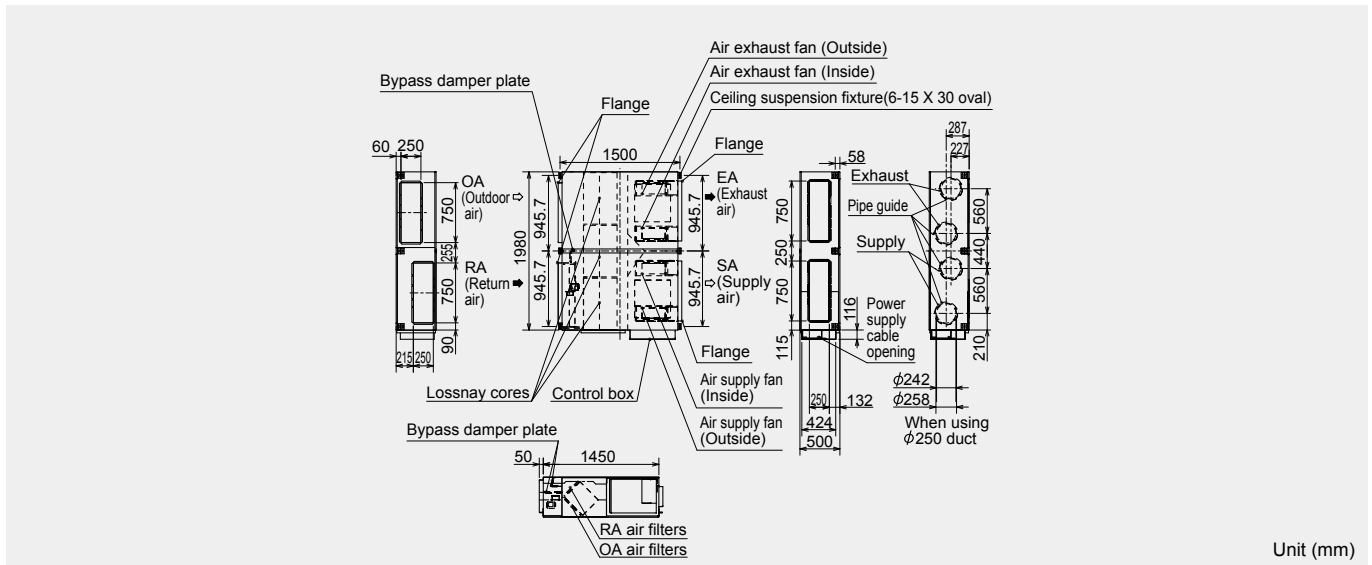

Unit (mm)

LGH-50RSDC-E1

Model		LGH-50RSDC-E1										
Electrical power supply		220-240V/50Hz										
Ventilation mode		Heat recovery mode					Bypass mode					
Fan speed		1	2	3	4	5	Power	1	2	3	4	5
Running current (A)		1.17	0.67	0.35	0.20	0.13	1.80	1.20	0.70	0.35	0.20	0.13
Input power (W)		165	90	41	22	14	265	164	90	40	21	14
Air volume	(m ³ /h)	395	305	215	144	90	468	395	305	215	144	90
	(L/s)	110	85	60	40	25	130	110	85	60	40	25
External static pressure (Pa)		100	60	30	15	7	135	100	60	30	15	7
Temperature exchange efficiency (%)		77.5	81.5	85.5	88	90	—	—	—	—	—	—
Enthalpy exchange efficiency (%)	Heating	71	75	79	82	84	—	—	—	—	—	—
	Cooling	68	72.5	77	80.5	83	—	—	—	—	—	—
Noise (dB) (Measured at 1.5m under the center of panel in an anechoic chamber)		31	26.5	21	18	18	35	31	26.5	21	18	18
Weight (kg)		48										

*This specifications are under 230V/50Hz.

*Exchange efficiency test condition is following.

Winter heating condition (EN308) OA:5C°DB 2.5C°WB, RA:25C°DB 14C°WB

Summer cooling condition (JIS B 8628) OA:34.5C°DB 30.5C°WB, RA:26.5C°DB 21.5C°WB

*Figures in the chart is measured according to Japan Industrial Standard (JIS B 8628) except temperature and humidity condition of exchange efficiency test. Characteristic Curves are measured by chamber method.

*This model does not have the functions on page 12 to 16.

Characteristic Curve

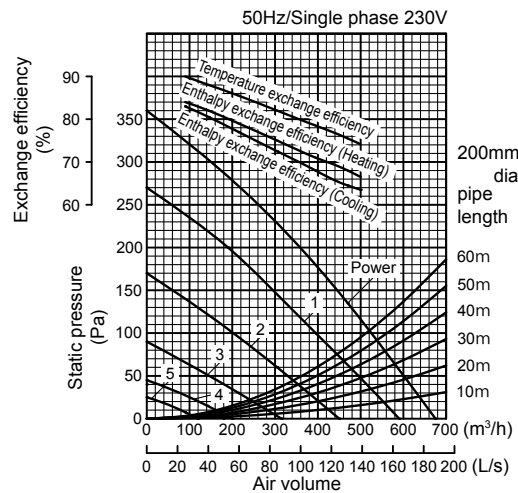

Dimensions

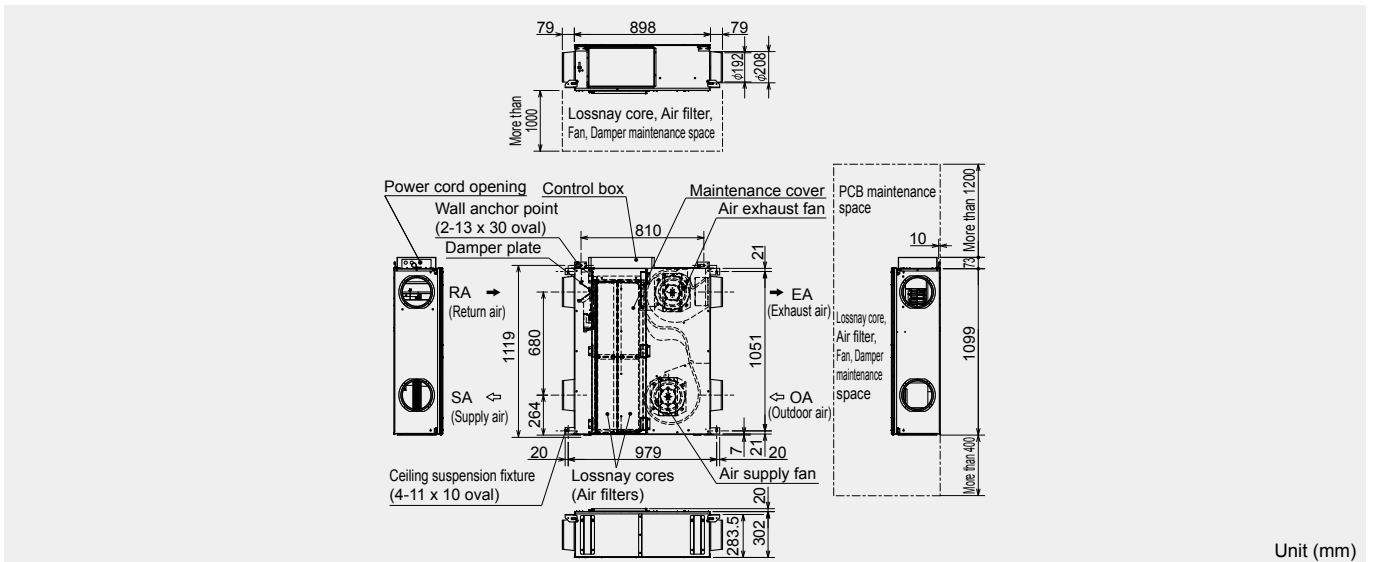

Unit (mm)

LGF-100GX-E



Hygiene Certified According to VDI6022

This model is compliant with hygiene regulation "VDI6022" (German regulation).
 All components are easy to be access and cleaned from front panel.
 The front panel opens for easy cleaning and maintenance.

Easy Maintenance



LGF-100GX-E

Top Out Duct Flange Style



The floor standing type is perfect for placement in mechanical rooms.
 Due to its top-duct flange style the top has space for flexible installation and duct work.

Multi Ventilation Mode

Featuring "Multi-ventilation Mode," which allows the air supply/exhaust balance to be varied dynamically.
 The supply/exhaust balance can be selected to suit the usage environment and location, such as allowing for air exhausted via extractor fans. Modes can be selected easily by setting the dip-switches on the circuit board.

Remote Controller	Ventilation mode	Supply airflow	Exhaust airflow	Unit setting (* Factory setting is "High" for both supply and exhaust.)	
				Air supply	Air exhaust
High	Power air supply/exhaust mode	High	High	High	High
	Power air supply mode	High	Low	High	Low
	Power air exhaust mode	Low	High	Low	High
Low	Energy-saving ventilation mode	Low	Low	Air supply and exhaust are "Low" irrespective of unit setting.	

* "High fan speed" can also be further set to "Extra High" using the unit switch.

Offers choice of 9 air supply/exhaust combination patterns.

Normal office, etc.

Providing efficient ventilation while maintaining air supply/exhaust balance...

Power air supply /exhaust

Smaller offices or tenant buildings, etc.

Using Lossnay compensates for using extractor fans...

Power air supply

Smoking areas, etc.

Priority on air exhaust...

Power air exhaust

• While every effort has been made to represent product colours herein accurately, slight deviations from actual colour may be noted due to the printing process.

MODEL

LGF-100GX-E

LGF-100GX-E

Model		LGF-100GX-E					
Electrical power supply		230V/50Hz					
Ventilation mode		Heat recovery mode			Bypass mode		
Fan speed		Extra high	High	Low	Extra high	High	Low
Running current (A)		4.20	3.50	3.45	4.35	3.75	3.70
Input power (W)		922	790	785	960	845	840
Air volume	(m ³ /h)	995	995	890	995	995	890
	(L/s)	276	276	247	276	276	247
External static pressure (Pa)		200	150	119	200	150	119
Temperature exchange efficiency (%)		80	80	81	—	—	—
Enthalpy exchange efficiency (%)	Heating	72.5	72.5	74	—	—	—
	Cooling	71	71	72	—	—	—
Noise (dB) (Measured at 1.0m away from the unit in an anechoic chamber)		49	47	44	51	49	46
Weight(kg)		164					

*Figures in the chart is measured according to Japan Industrial Standard (JIS B 8628). Characteristic Curves are measured by chamber method.

Characteristic Curve

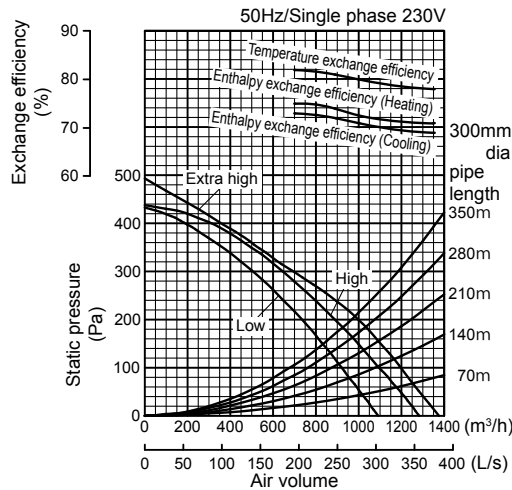

Dimensions

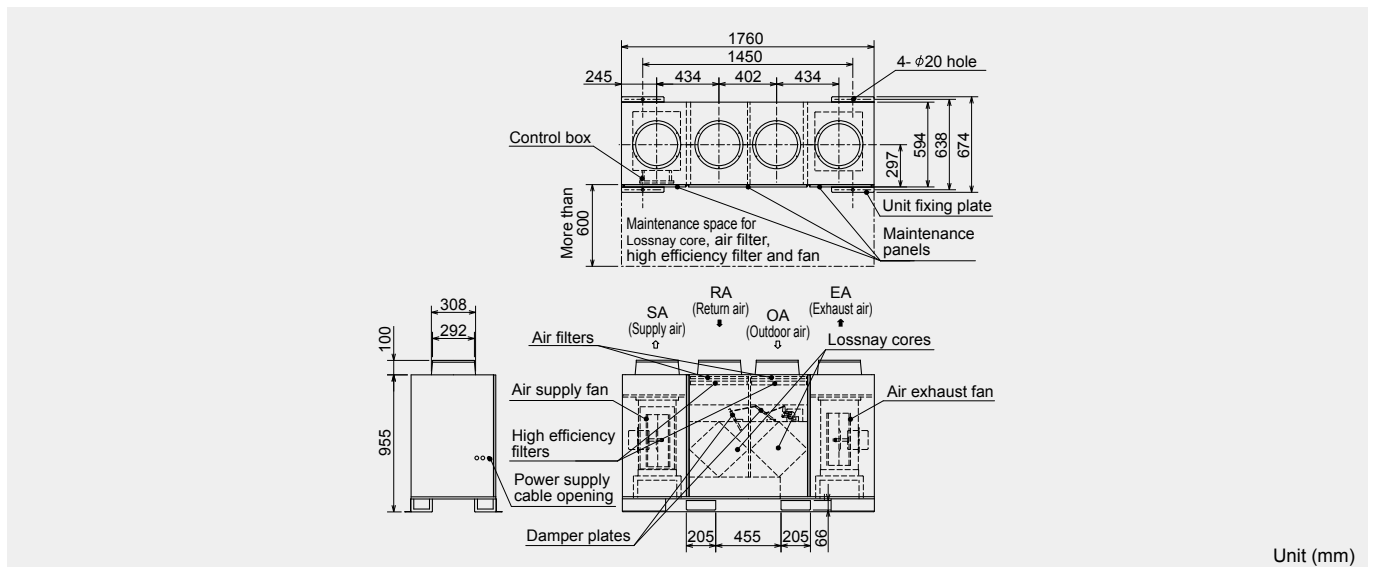

GUF Series



Lossnay Ventilation and Air Conditioning

The OA (Outdoor-air) Processing Unit creates an optimum environment while providing substantial energy savings. The OA Processing Unit comprises forced air ventilation, heat recovery, heating and cooling, and air purification. This total air conditioning system keeps indoor air fresh and comfortable all year round, and keeps it free of contaminants preventing ailments such as sick building syndrome. Inside the OA Processing Unit is the Lossnay core, a heat exchange unit that transfers heat efficiently, cutting ventilation load by as much as 70%. A remarkable product found nowhere else, this special combination of functionality and performance contained within a single unit ensures users ample comfort, good health, and energy savings.

GUF-RD type

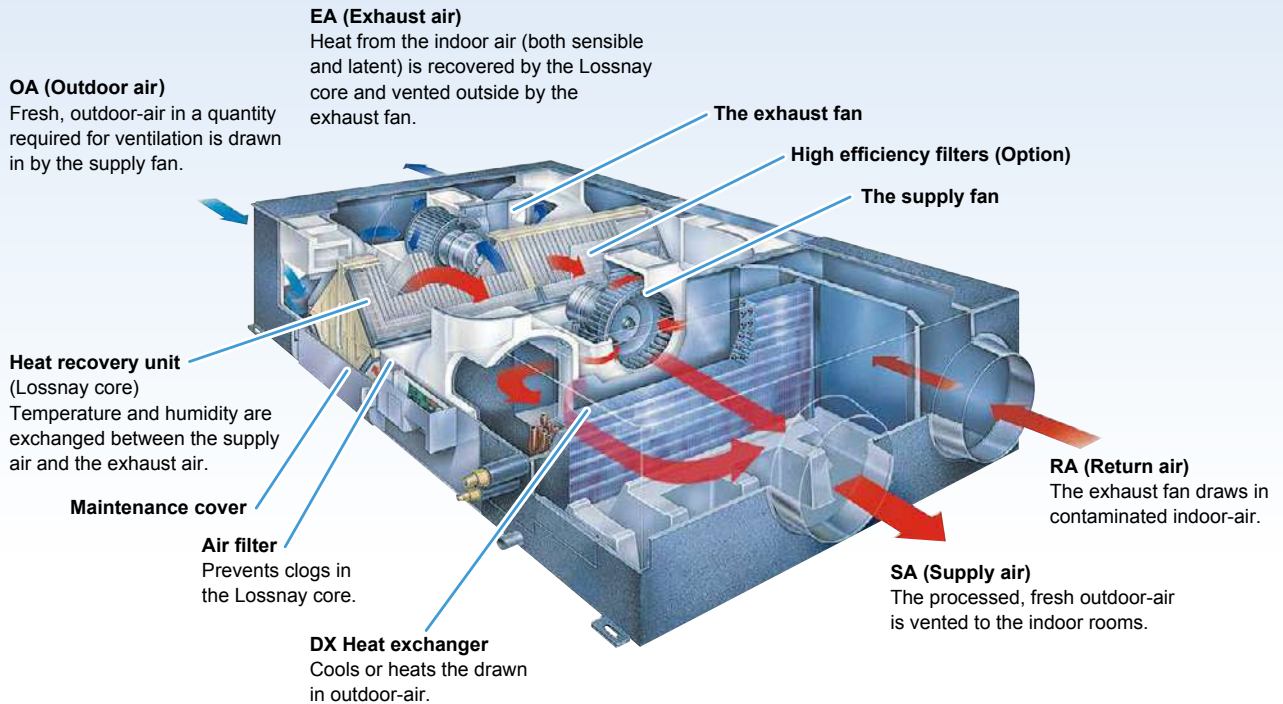

GUF Series

GUF-RDH type

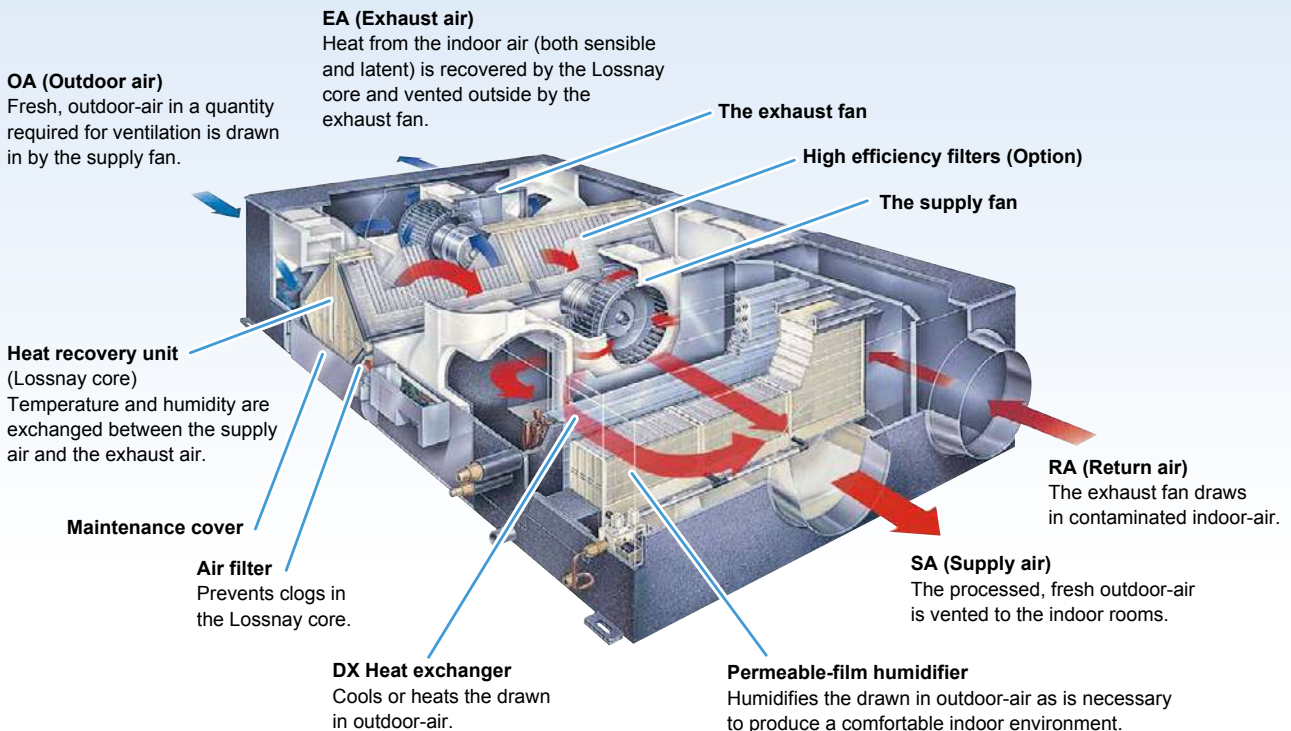

These Units can be Used on R410A. GUF-RD and RDH type

Outdoor units available in the GUF-RD/RDH series:

(For details see Mitsubishi Electric's "CITY MULTI" catalogue)

R410A refrigerant units

Model size	P200	P250	P300	P350	P400	P450	P500	P550	P600	P650	P700	P750	P800
Y series	●	●	●	●	●	●	●	●	●	●	●	●	●
R2 series	●	●	●	●	●	●	●	●	●	●			

Permeable Film Humidifier GUF-RDH type only

Comfortable Level of Humidity for Exceptionable Air Quality

The OA Processing Unit is equipped with a permeable film humidifier developed by Mitsubishi Electric. Steam transmission efficiency has been improved remarkably by lowering the resistance of the material. By providing an optimum level of humidity, the OA Processing Unit creates a comfortable interior environment preventing irritations such as dried out eyes or a parched throat that can be caused by insufficiently low levels of humidity in the air.

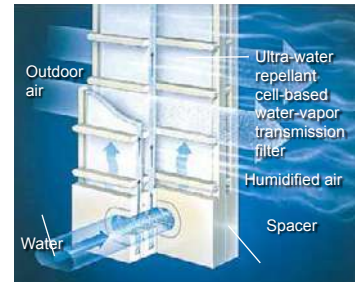

Highly Efficient Humidification

Improvements in the system of airflow patterns and water injection techniques have resulted in a substantial increase in humidifying volume. The system also controls the humidity level of the air that is exhausted, ensuring an efficient, environmentally friendly manner of operation.

Note: In the case in which the level of residual impurities exceeds 100mg/l please use a water purifier

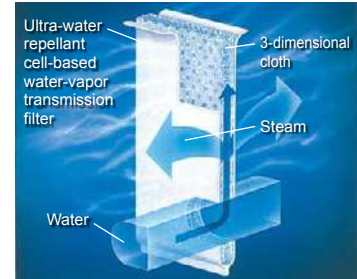

Dual-Fan System GUF-RD and RDH type

Reliable Ventilation

The OA Processing Unit utilizes a dual-fan configuration for the intake and exhaust of air from a building. A forced air method is incorporated for the simultaneous supply and exhaust of air to guarantee effective ventilation even in highly insulated air-tight rooms. The Lossnay core is designed such that the passages for air being drawn into and exhausted from a building are entirely separate. This setup prevents the mixing of indoor and outdoor air for safe, reliable ventilation.

Free Cooling GUF-RD and RDH type

When the air-conditioning system is operating in its cooling mode and the temperature of the air outdoors drops below the temperature indoors (e.g. a summer night), the OA Processing Unit detects this and automatically switches to a mode of operation which bypasses the heat recovery unit. Bringing in cool air from outside serves to help reduce the air conditioner's cooling load.

Heat Processing GUF-RD and RDH type

A direct expansion heat exchanger is incorporated to compensate for any heat loss that may occur during ventilation. It also improves the efficiency of humidification in the winter.

Variable Duct Positions GUF-RD and RDH type

The connection position of the outside duct is variable allowing for more complicated duct installations.

Standard installation	Installation with duct direction changed
<p>A space is necessary to prevent the influx of rainwater.</p> <p style="text-align: center;">EA ↓ ↑ OA</p>	<p>Can be installed close to the surface of the wall.</p> <p style="text-align: center;">EA ↓ ↑ OA</p> <p>Avoid installations where the stale air exhaust aperture would be blocked by lighting or air conditioning units.</p> <p style="text-align: center;">EA ↓ ↑ OA</p>

*There is no pressure loss with a change in the duct position.

MODEL

GU-F-50/100RD4

GUF Series

Model		GU-F-50RD4				GU-F-100RD4				
Electrical power supply		220-240V/50Hz				220-240V/50Hz				
Ventilation mode		Heat recovery mode		Bypass mode		Heat recovery mode		Bypass mode		
Fan speed		High	Low	High	Low	High	Low	High	Low	
Running current (A)		1.15	0.70	1.15	0.70	2.20	1.73	2.25	1.77	
Input power (W)		235-265	150-165	235-265	150-165	480-505	370-395	490-515	385-410	
Air volume		(m ³ /h)	500	400	500	400	1000	800	1000	800
		(L/s)	139	111	139	111	278	222	278	222
External static pressure (Pa)		140	90	140	90	140	90	140	90	
Temperature exchange efficiency (%)		77.5	80	—	—	79.5	81.5	—	—	
Enthalpy exchange efficiency (%)		Heating	68	71	—	—	71	74	—	—
		Cooling	65	67	—	—	69	71	—	—
Cooling capacity (kW)		5.57(1.94)				11.44(4.12)				
Heating capacity (kW)		6.21(2.04)				12.56(4.26)				
Capacity equivalent to the indoor unit		P32				P63				
Noise (dB) (Measured at 1.5m under the center of the unit)		33.5-34.5	29.5-30.5	35-36	29.5-30.5	38-39	34-35	38-39	35-36	
Weight (kg)		48				82				

*Cooling/Heating capacity indicates the maximum value at operation under the following condition.

Cooling: Indoor: 27 cDB/19 cWB Outdoor: 35 cDB/24 cWB

Heating: Indoor: 20 cDB/13.8 cWB Outdoor: 7 cDB/6 cWB

*The figures in () indicates heat recovering capacity of heat exchange core.

*Figures in the chart is measured according to Japan Industrial Standard (JIS B 8628). Characteristic Curves are measured by chamber method.

Characteristic Curve of the GU-F-50RD4

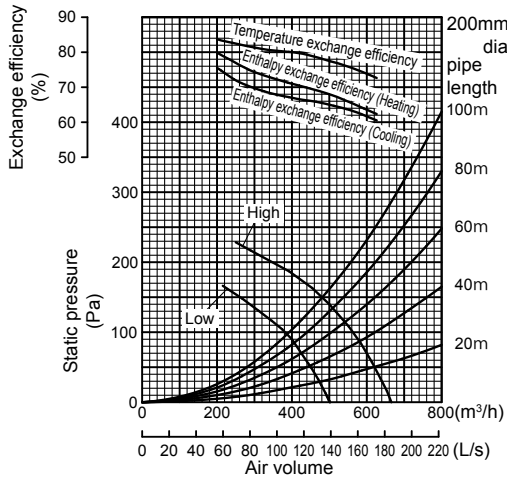

Characteristic Curve of the GU-F-100RD4

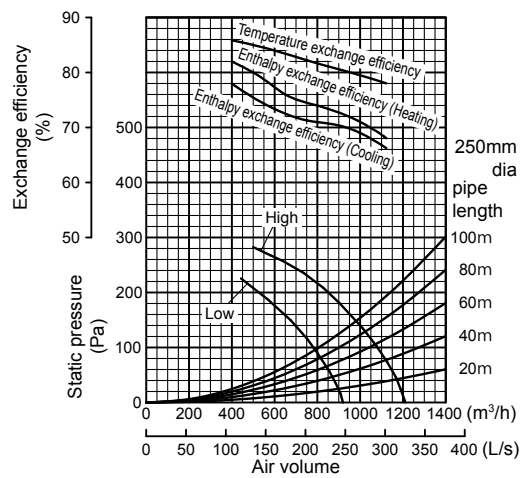

Dimensions of the GU-F-50RD4

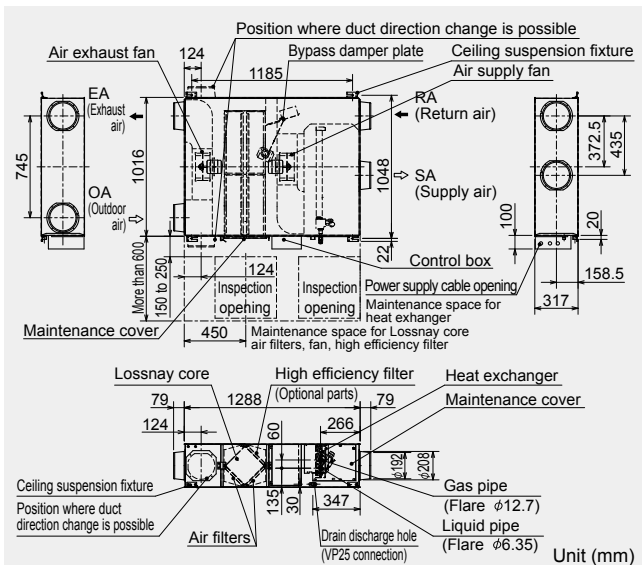

Dimensions of the GU-F-100RD4

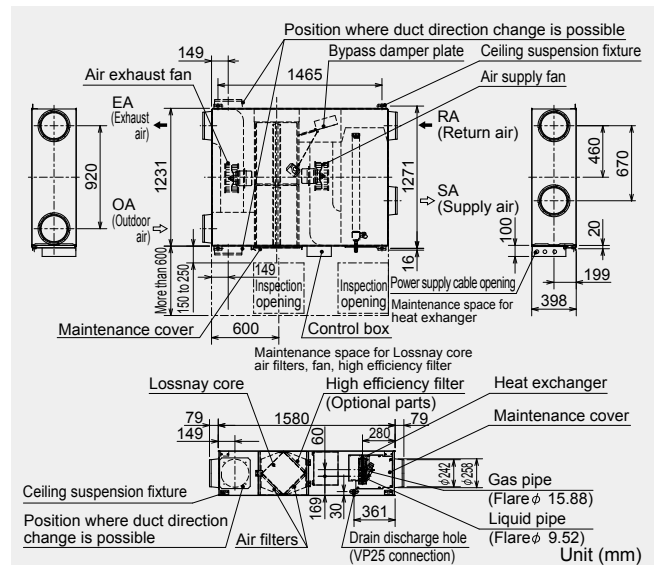

• Certain ratings and specifications may change due to product improvements or modifications. • Refer to the product manuals for safety precautions.

GU-F-50/100RDH4

Model		GU-F-50RDH4				GU-F-100RDH4				
Electrical power supply		220-240V/50Hz								
Ventilation mode		Heat recovery mode		Bypass mode		Heat recovery mode		Bypass mode		
Fan speed		High	Low	High	Low	High	Low	High	Low	
Running current (A)		1.15	0.70	1.15	0.70	2.20	1.76	2.25	1.77	
Input power (W)		235-265	150-165	235-265	150-165	480-505	385-400	490-515	385-410	
Air volume		(m ³ /h)	500	400	500	400	1000	800	1000	800
		(L/s)	139	111	139	111	278	222	278	222
External static pressure (Pa)		125	80	125	80	135	86	135	86	
Temperature exchange efficiency (%)		77.5	80	—	—	79.5	81.5	—	—	
Enthalpy exchange efficiency (%)		Heating	68	71	—	—	71	74	—	—
		Cooling	65	67	—	—	69	71	—	—
Cooling capacity (kW)		5.57(1.94)				11.44(4.12)				
Heating capacity (kW)		6.21(2.04)				12.56(4.26)				
Capacity equivalent to the indoor unit		P32				P63				
Humidifier	Humidifying	Permeable film humidifier								
	Humidifying capacity(kg/h)	2.7(heating)				5.4(heating)				
	Water supply pressure	Minimum pressure : 2.0 × 10 ⁴ Pa				Maximum pressure : 49.0 × 10 ⁴ Pa				
Noise (dB)	(Measured at 1.5m under the center of the unit)	33.5-34.5	29.5-30.5	35-36	29.5-30.5	38-39	34-35	38-39	35-36	
Weight (kg)		51(filled with water 55)				88(filled with water 96)				

*Cooling/Heating capacity indicates the maximum value at operation under the following condition.
 Cooling: Indoor: 27 cDB/19 cWB Outdoor: 35 cDB/24 cWB
 Heating: Indoor: 20 cDB/13.8 cWB Outdoor: 7 cDB/6 cWB
 *The figures in () indicates heat recovering capacity of heat exchange core.
 *Figures in the chart is measured according to Japan Industrial Standard (JIS B 8628). Characteristic Curves are measured by chamber method.

Characteristic Curve of the GU-F-50RDH4

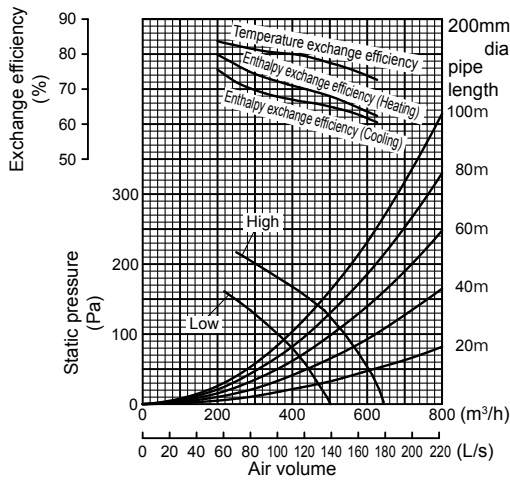

Characteristic Curve of the GU-F-100RDH4

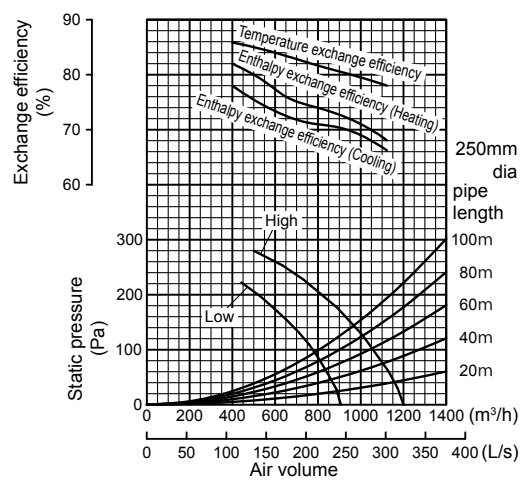

Dimensions of the GU-F-50RDH4

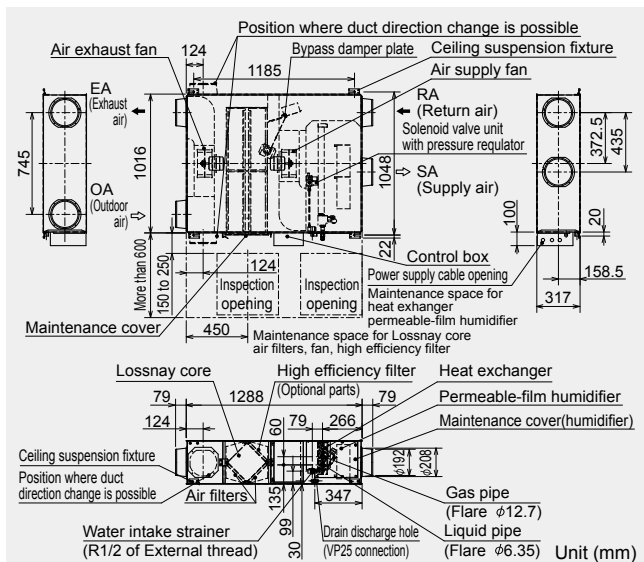

Dimensions of the GU-F-100RDH4

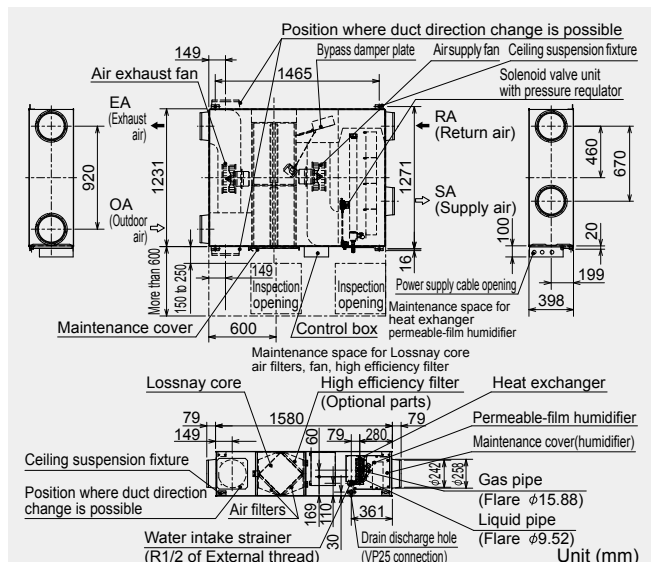

VL-220CZGV-E



Unprecedented energy saving ventilation system will fulfill your life environment more comfortable and enhance the indoor environment with a energy-saving ventilation system.

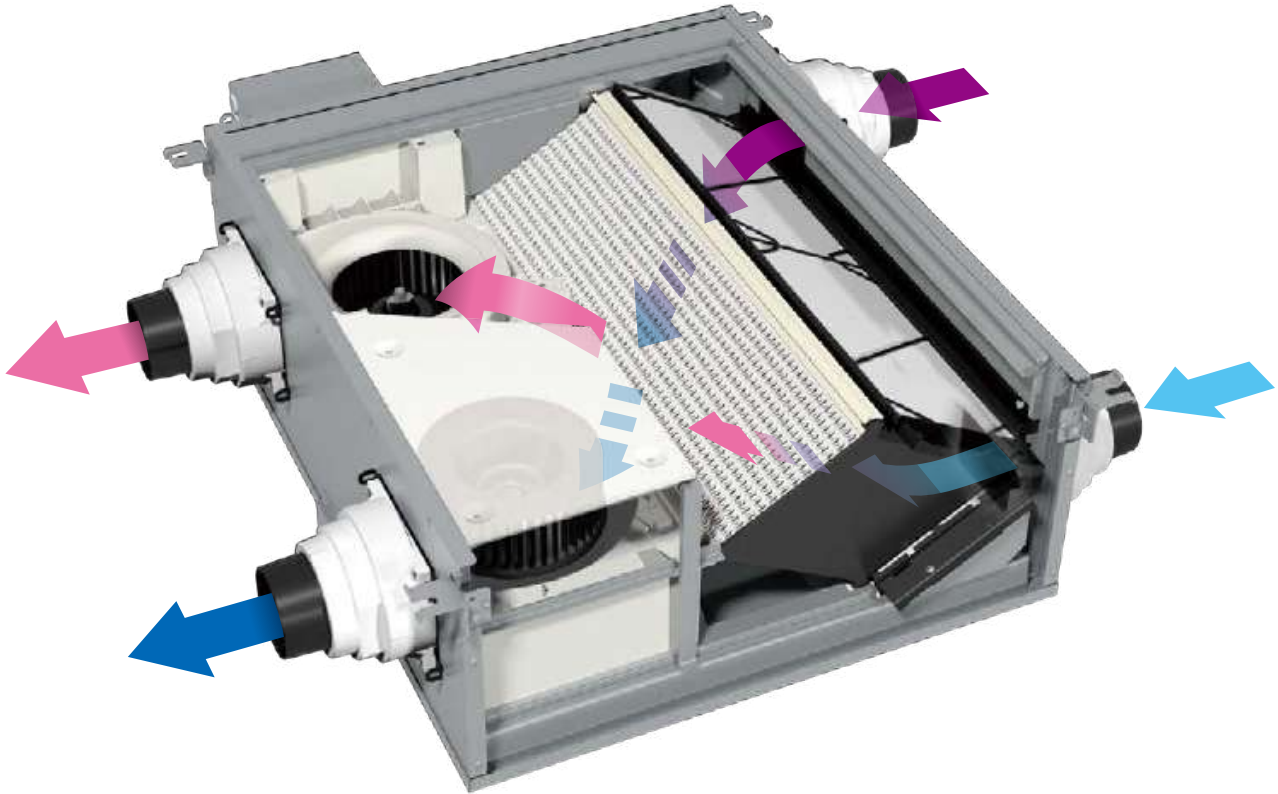

VL-220CZGV-E

Smart Ventilation

More comfortable!

- Minimizes temperature difference
- Shuts out outside noise
- Filter cuts pollen and dust for fresh clean air

More energy saving!

- 86% maximum exchange efficiency
- Reduces load on air conditioning (heating and cooling)
- Equals saving on your energy costs



One Lossnay unit provides 24 hours ventilation for the entire house from the living areas to the bathroom.

The heat recovery system provides fresh air at a comfortable air temperature.

The energy saved by using Lossnay contributes directly towards lowering heating or cooling expenses.

The sensible heat exchanger type is effective for decreasing excess humidity in the winter.

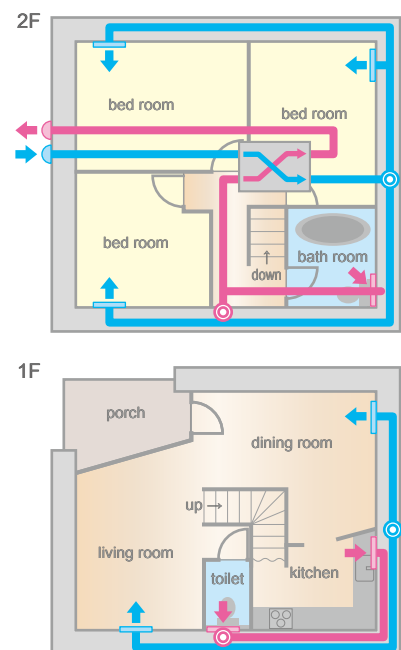
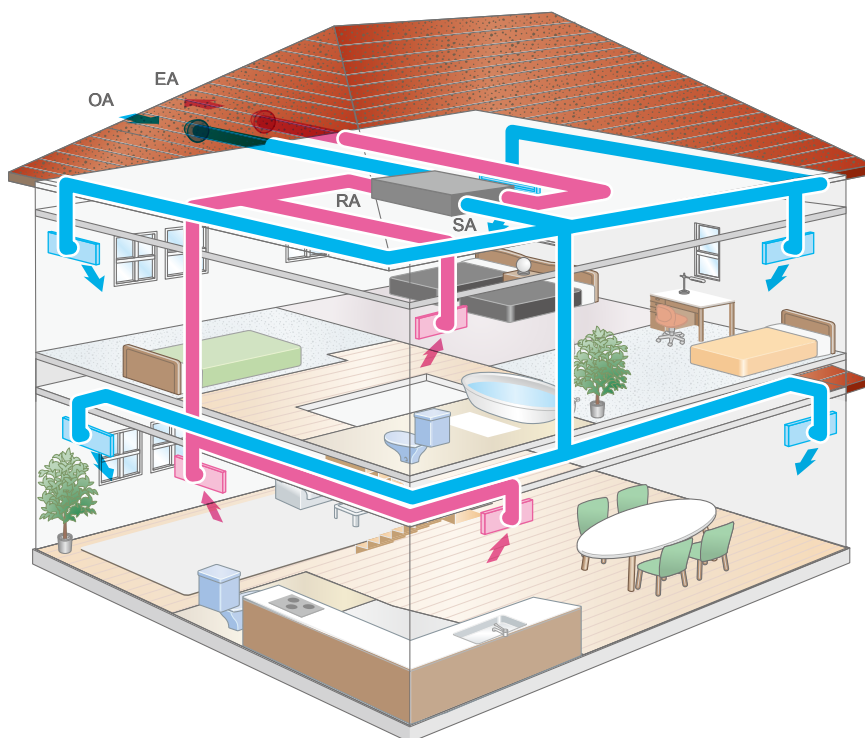

VL-220CZGV-E

Product Merits

Newly Developed Heat Exchanger

- During ventilation, Lossnay recovers warmth in the winter and keeps air cool in the summer.
- Reducing heating and cooling loads with a maximum exchange efficiency of 86%.

Normal Square Heat Exchanger

Simple structure contributes to minimize pressure loss and reduce power consumption.

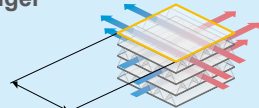

New Diamond Heat Exchanger

Due to the diamond design, air passages are longer and help realize higher exchange efficiency.

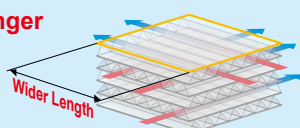

Energy Efficient

- The highest energy saving in its class. (8.5W minimum input power)
- Saves heating and cooling costs by minimizing energy loss occurring during ventilation.



Quiet

- At an ultra quiet 14dB, it is the quietest product in its class.
- Blocks outside noise for a more comfortable environment.



Fan Speed Setting

Widely adjustable fan speed

This model can operate at four main fan speeds. In addition, each speed has a range setting of approximately 25, 50, 75 and 100%, allowing optimum air volume control.

When used in combination with the CO₂ sensor or timer function, the air volume can be controlled according to conditions that realize better performance and reduce power consumption.

■VL-220CZGV-E characteristic curves

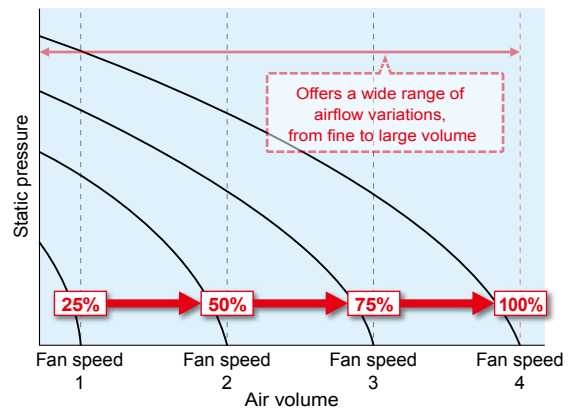

Fan speed precise adjustment function

Each main fan speed value can be further adjusted slightly. Use the PZ-61DR-E remote controller to adjust the speed.

- 1) Considering the total hours of Lossnay operation (filter clogging), the fan power can be adjusted automatically after a given period of time.
- 2) After the unit is installed, when if the air volume is slightly lower or higher than the desired airflow, it is possible to make fine adjustments.
(Fan speed 4 is available only 1down and 2down)

■P-Q curve image

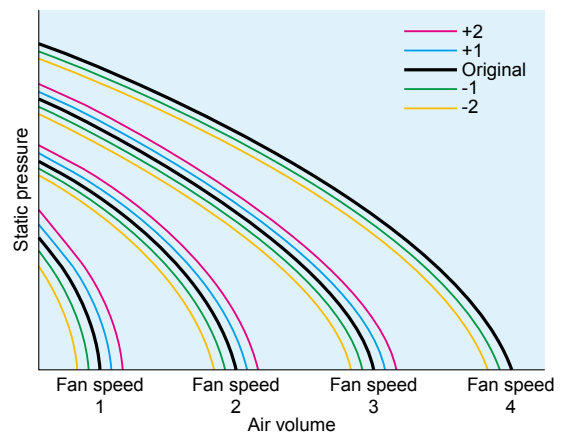

VL-220CZGV-E

Maintenance

To keep the Lossnay unit in optimal condition, clean dirt and dust from the filters and the drain pan periodically (at least once every six months or more, depending on the operating environment).

1) Draw out filters after unlocking the fixing knobs

Supply air filter case



It holds the supply air filter or High efficiency supply air filter.

Supply air filter fixing knob

Release it to remove the supply air filter case. (3 locations)

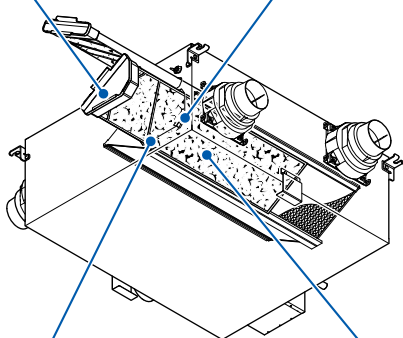

Drain pan (supply air side)

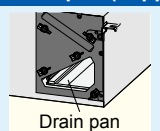

It holds dew condensation water that occurs inside the Lossnay unit.

Supply air filter

It removes insects, pollen, dirt, dust, and other particles from the outside air that is taken into the room.

2) Remove the air filters from the filter cases

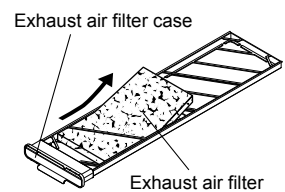
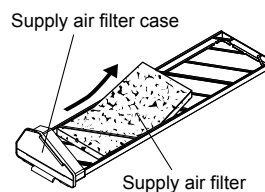

3) Clean at least once every six months

Lightly tap or remove dust with a vacuum cleaner

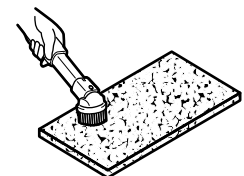



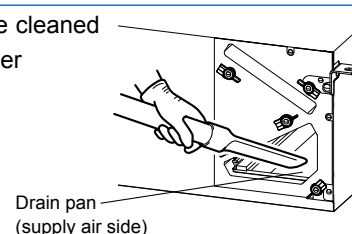

4) The drain pan can be cleaned with a vacuum cleaner



Control

Multi ventilation (power supply / exhaust) mode

This mode allows the air supply/exhaust balance to be varied dynamically. The supply/exhaust balance can be selected to suit the usage environment.

Nomal Mode	Power Supply Mode	Power Exhaust Mode
Relax time 	Adjust the indoor pressure balance in case a separate exhaust is installed 	Increase indoor pressure to prevent unfiltered drafts from coming in 
	Keep steam inside of the shower room 	Prevent odors from spreading 

Weekly timer

The operation pattern for each day of the week. ON / OFF and air volume can be set using the weekly timer function (up to eight zones per day). This function contributes to enhanced energy saving operation.

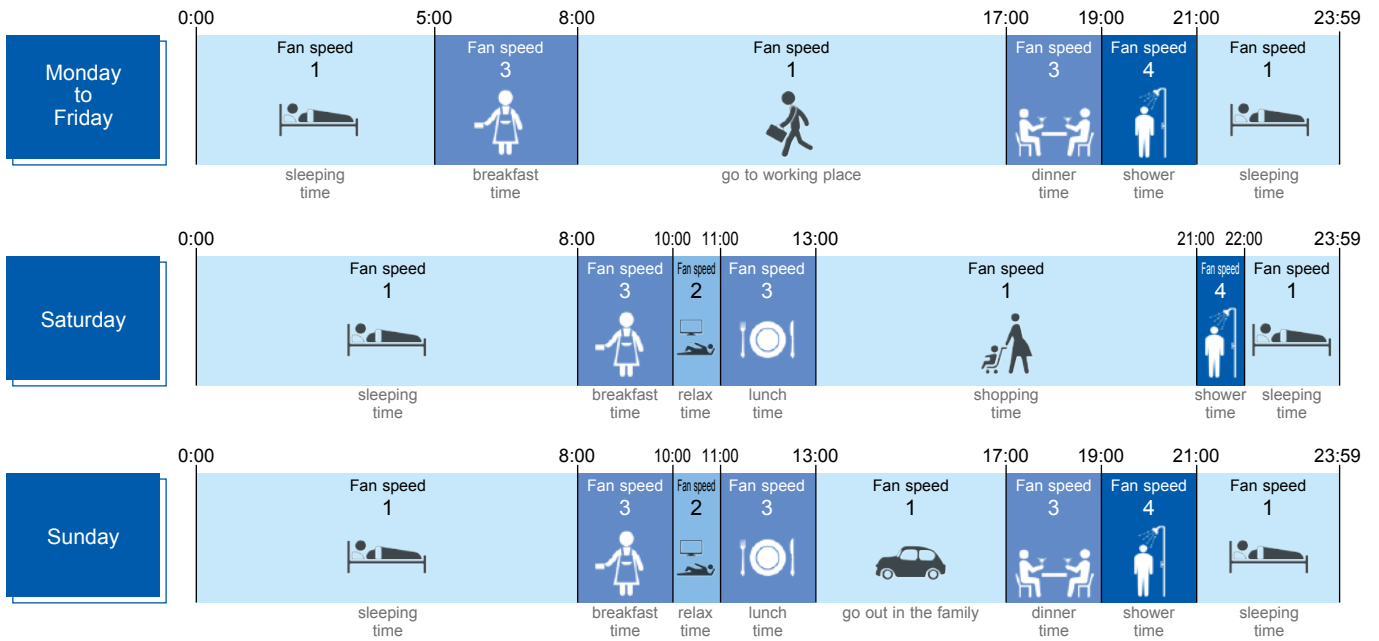

*Example for reference only.

Free cooling mode

During the summer season, the free cooling mode draws cooler outside air into the room. This mode contributes to reduced loads on air conditioning. For this operation, an optional bypass damper P-133DUE-E is required. The user is able to set the OA temp. depending on the preference between 10°C to 30°C.

P-133DUE-E attached to VL-220CZGV-E

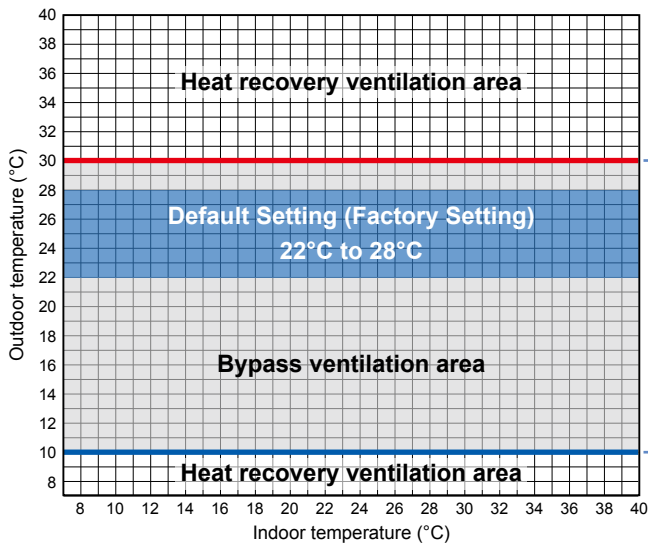

The remote controller PZ-61DR-E can set the free cooling temp. zone: Max: 30°C, Min: 10°C

<Piping example>

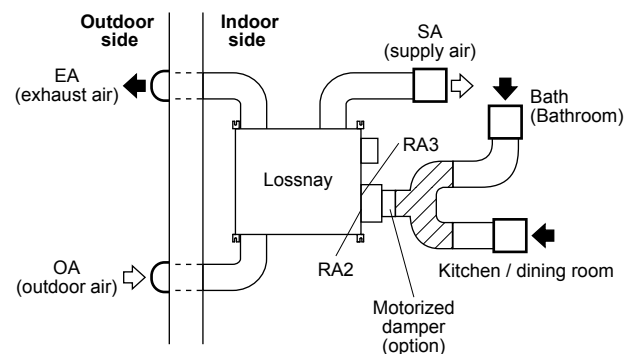

VL-220CZGV-E

Model		VL-220CZGV-E			
Electrical power supply		220-240V/50Hz 220V/60Hz			
Ventilation mode		Heat recovery mode			
Fan speed		Fan speed 4	Fan speed 3	Fan speed 2	Fan speed 1
Running current		0.60	0.29	0.18	0.11
Input power (W)		80	35	18.5	8.5
Air volume	(m ³ /h)	230	165	120	65
	(L/s)	64	46	33	18
External static pressure (Pa)		164	84	44	13
Temperature exchange efficiency (%)		82.0	84.0	85.0	86.0
Noise (dB)		31.0	25.0	19.0	14.0
Weight (kg)		31			
Specific energy consumption class		A			

Characteristic Curve

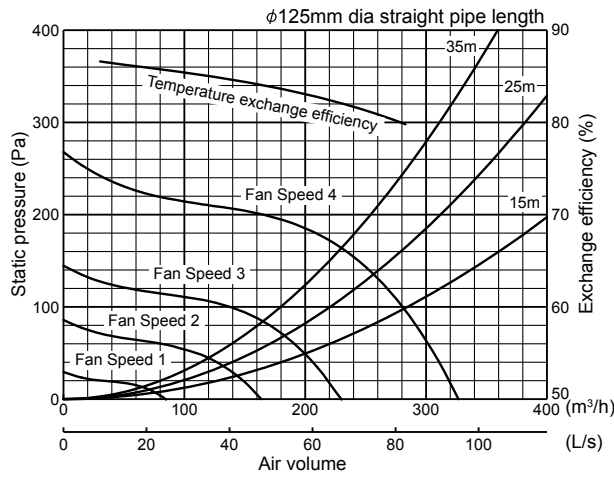

VL-220CZGV-E

Dimensions

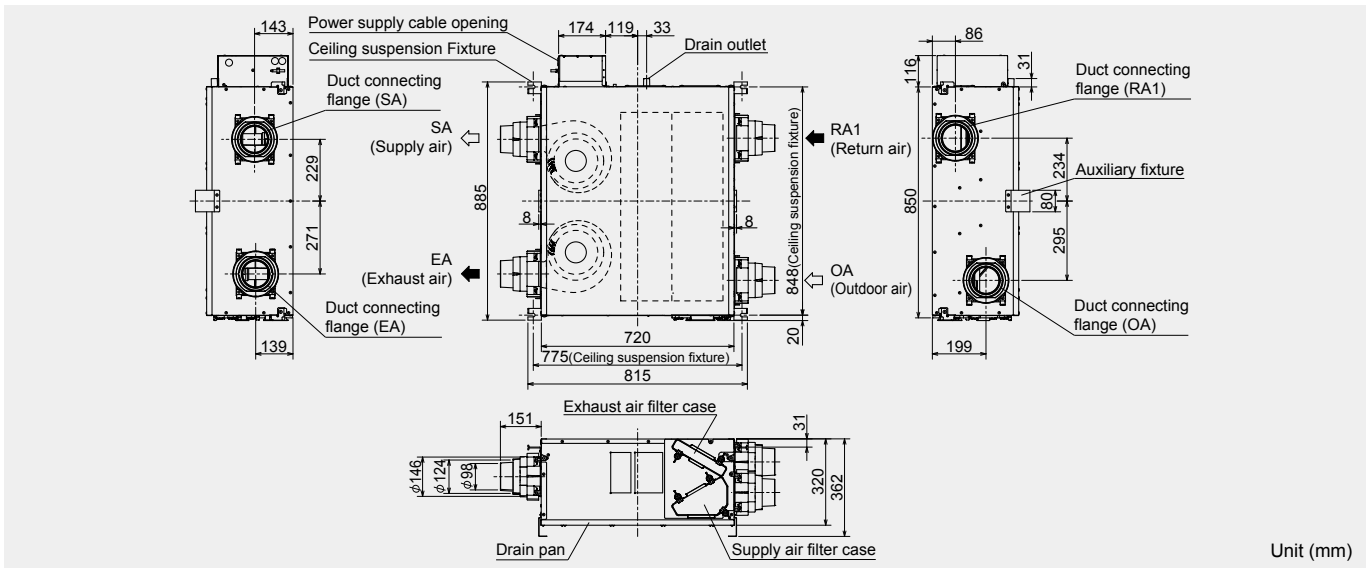

VL-100 (E) U5-E



Stylish Design

VL-100U₅-E <Pulling switch model>

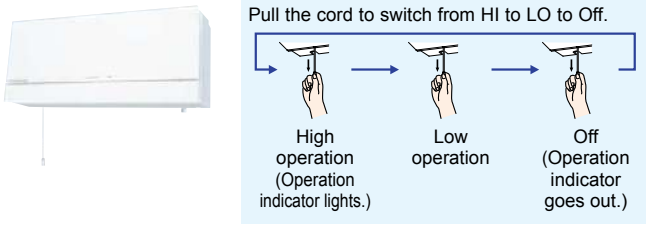

VL-100EU₅-E <Wall switch model>

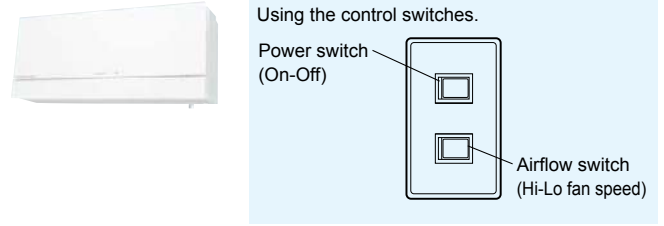

Simple Installation

Easy installation through boring of 2 installation holes. All of the parts needed for installation is including the carton box of the products.

Easy Maintenance

1. Remove the Lossnay core

Press the prong of the Lossnay core's handle and pull the handle toward you to remove the core.

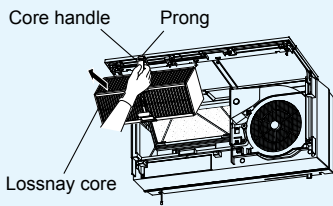

2. Remove the Filters

- 1) Pressing on the filter frame prong, pull the filter toward you to remove the filter frame from the main unit.
- 2) Remove the outside air filter from its filter frame.

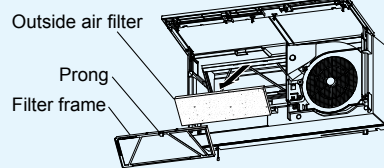

3. Cleaning

Vacuum the dust from the filter, and then handwash it in water with a neutral detergent or in lukewarm water (up to 40°C). Then dry it thoroughly to remove moisture.

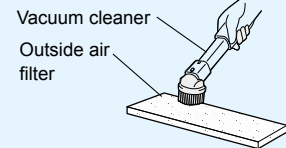

Low Noise Design

By providing a range of air volume for each fan speed, sound levels can be reduced to achieve low noise. (Less than 30dB at low fan speed)

Total Heat Exchnage

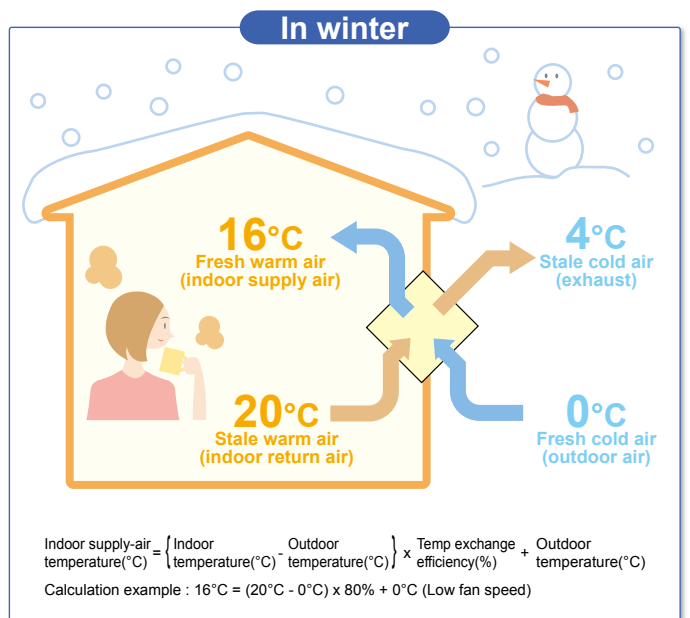
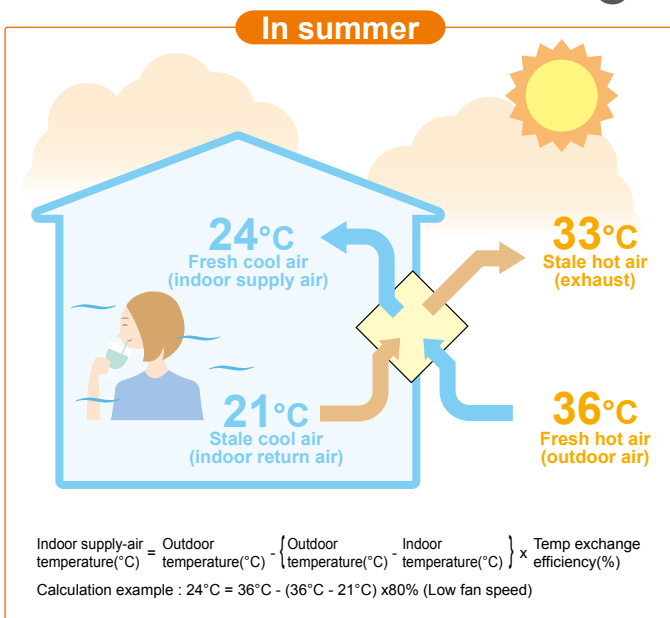

• While every effort has been made to represent product colours herein accurately, slight deviations from actual colour may be noted due to the printing process.

MODEL

VL-100 (E) U₅-E

Model	VL-100(E)U ₅ -E							
	220V/50Hz		230V/50Hz		240V/50Hz		220V/60Hz	
Electrical power supply	220V/50Hz		230V/50Hz		240V/50Hz		220V/60Hz	
Fan speed	High	Low	High	Low	High	Low	High	Low
Air volume (m ³ /h)	100	55	105	60	106	61	103	57
Power consumption (W)	30	13	31	15	34	17	34	17
Temperature exchange efficiency (%)	73	80	73	80	72	79	73	80
Noise (dB)	36.5	24	37	25	38	27	38	25
Weight (kg)	7.5							
Specific energy consumption class	B							

Dimensions

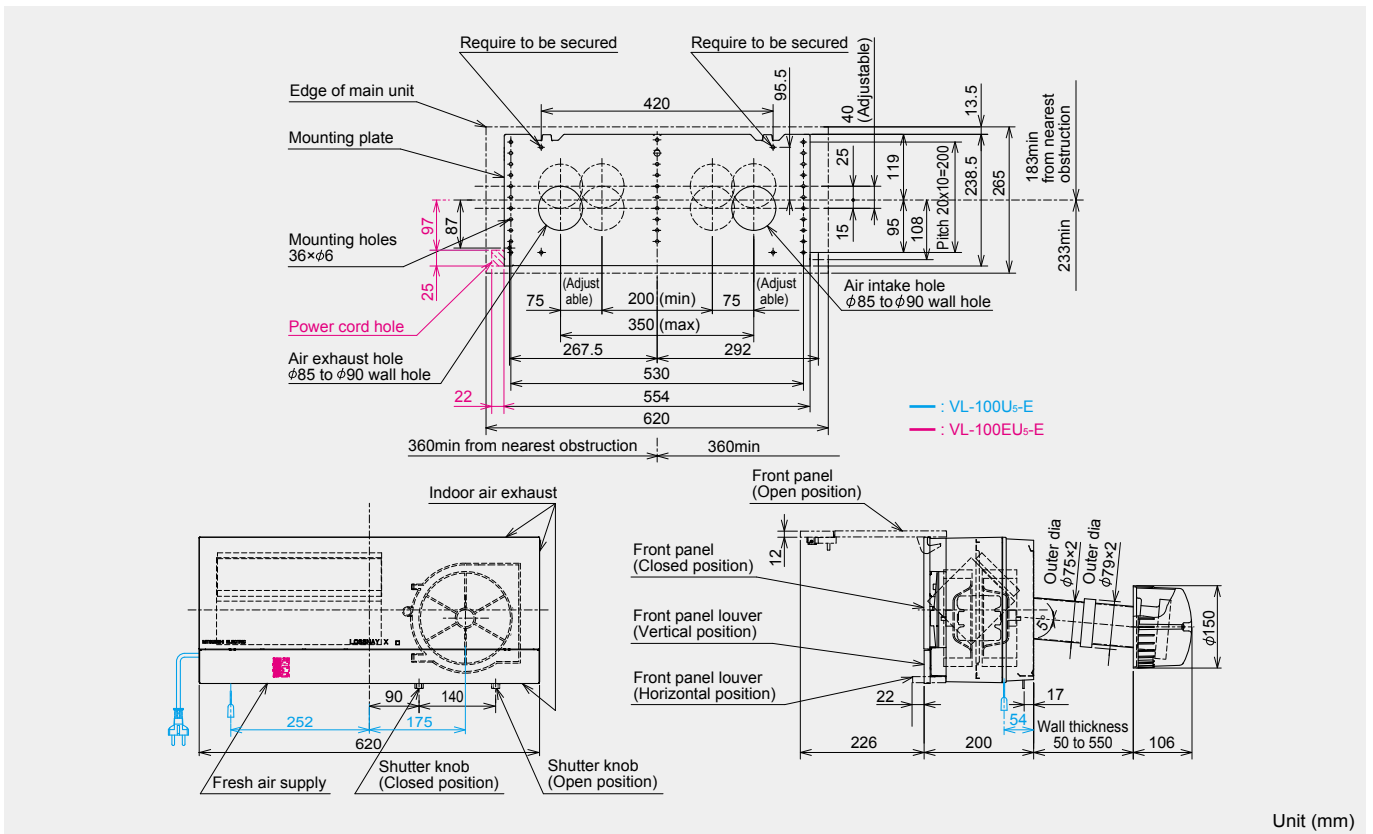

VL-100 (E) U₅-E

Optional Parts List

Remote controller

PZ-61DR-E



PZ-43SMF-E



PZ-60DR-E

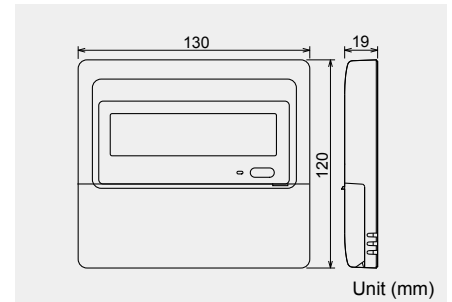
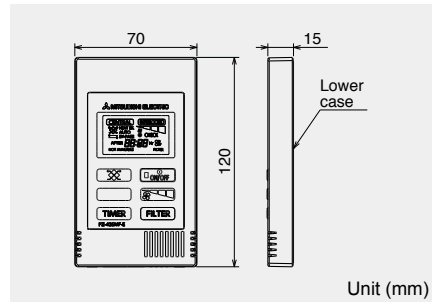
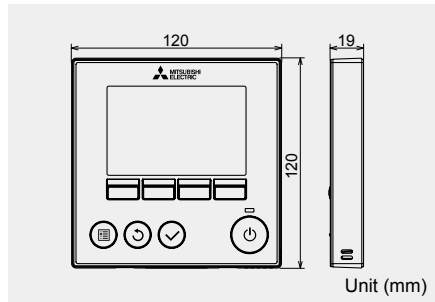

Function (Communicating Mode)	PZ-61DR-E		PZ-43SMF-E			PZ-60DR-E
	LGH-RVX/RVXT	VL-220CZGV-E	LGH-RVX/RVXT	LGF-100GX-E	VL-220CZGV-E	LGF-100GX-E
Fanspeed selection	4 fan speeds	4 fan speeds	2 of 4 fan speeds	2 of 3 fan speeds	2 of 4 fan speeds	2 of 3 fan speeds
Ventilation mode selection	Energy recovery / Bypass / Auto	Heat recovery / Bypass / Auto (available with optional parts P-133DUE-E)	Energy recovery / Bypass / Auto	Energy recovery / Bypass / Auto	Heat recovery / Bypass / Auto (available with optional parts P-133DUE-E)	Energy recovery / Bypass / Auto
Night-purge (time)	Anytime schedule	No	No	No	No	Yes (1:00 am start - 6:00 am end)
Night-purge (fan speed)	Selecttable from 4 fan speeds	No	No	No	No	Same as last operation
Function setting from RC	Yes	Yes	No	No	No	Yes
Bypass temp. free setting	Yes	Yes (available with optional parts P-133DUE-E)	No	No	No	No
Heater-On temp. free setting	Yes	No	No	No	No	No
Fan power change after installation	Yes	Yes	No	No	No	No
On/Off timer	Yes	Yes	Yes	Yes	Yes	Yes
Auto-Off timer	Yes	Yes	No	No	No	Yes
Weekly timer	Yes	Yes	No	No	No	Yes
Operation restrictions (On/Off, ventilation mode, fan speed)	Yes	Yes (ventilation mode is available with optional parts P-133DUE-E)	No	No	No	Yes
Operation restrictions (fan speed skip setting)	Yes	Yes	No	No	No	No
Screen contrast adjustment	Yes	Yes	No	No	No	No
Language selection	Yes (8 languages)	Yes (8 languages)	No (English Only)	No (English Only)	No (English Only)	Yes (8 languages)
Initializing remote controller	Yes	Yes	No	No	No	Yes
Filter cleaning sign	Yes	Yes	Yes	Yes	Yes	Yes
Lossnay core cleaning sign	Yes	No	No	No	No	Yes
Error indication	Yes	Yes	Yes	Yes	Yes	Yes
Error history	Yes	Yes	No	No	No	Yes

Optional Parts for LGH and LGF type

Standard filter

Replacement components for the standard air filter supplied with the Lossnay LGH main unit.

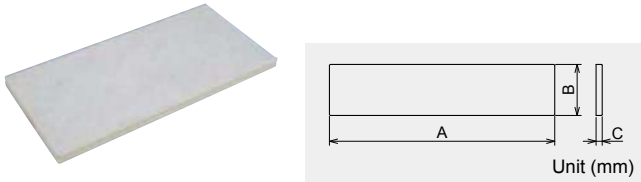

Model	Dimension (mm)			Number of filters per set		Applicable model	Filter material
	A	B	C	Supply	Exhaust		
PZ-15RF ₈ -E	557	130	20	1	1	LGH-15RVX-E	Nonwoven filter Filtration efficiency (EU-G3)
PZ-25RF ₈ -E	333	156	15	2	2	LGH-25RVX-E	
PZ-35RF ₈ -E	399	183	20	2	2	LGH-35RVX-E	
PZ-50RF ₈ -E	470	183	15	2	2	LGH-50RVX-E GUF-50RD(H)4	
PZ-65RF ₈ -E	433	218	15	2	2	LGH-65RVX-E	
PZ-80RF ₈ -E	451	243	15	2	2	LGH-80RVX-E LGH-150RVX-E(2sets)	
PZ-100RF ₈ -E	565	243	15	2	2	LGH-100RVXE GUF-100RD(H)4 LGH-200RVX-E(2sets)	

Model	Air	Dimension (mm)		Number of filters per set	Applicable model	Filter material
		A	B			
PZ-150RTF-E	Supply	655	290	2	LGH-150RVXT-E	Nonwoven filter Filtration efficiency (EU-G3)
	Exhaust	655	250			
PZ-250RTF-E	Supply	985	290	2	LGH-200RVXT-E LGH-250RVXT-E	Nonwoven filter Filtration efficiency (EU-G3)
	Exhaust	985	250			

Optional Parts for VL-220CZGV-E

Bypass damper

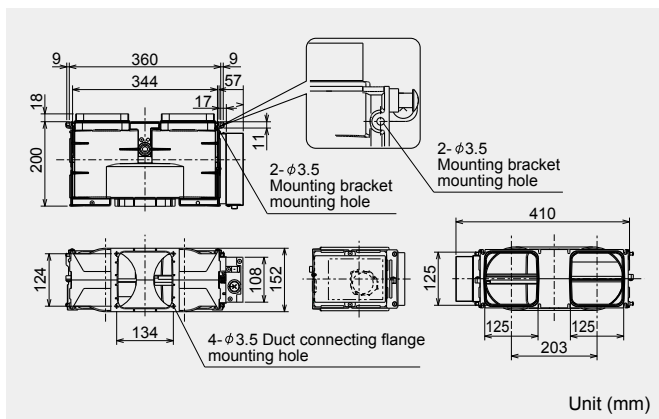

Filter type	High Efficiency Supply Air filter	Medium Efficiency Exhaust Air Filter	Standard Replacement Filter
Model	P-220SHF-E	P-220EMF-E	P-220F-E
Classification (EN779:2012)	M6	G4	G3
Approximate Service Life	1 year (replacement) Cannot be cleaned	2 year (replacement) Clean approximately once every 6 months	Replace when broken Can be washed with water and reused 4 times. Clean approximately once every 6 months.

High-efficiency filter

This high-efficiency filter (with 65% colorimetricity EU-F7:EN779:2002) can be incorporated inside the Lossnay unit without the need to attach parts from other systems, as done to date.

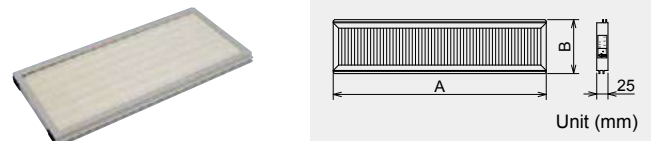

Model	Dimension (mm)		Number of filters per set	Applicable model	Filter material
	A	B			
PZ-15RFM-E	553	123	1	LGH-15RVX-E	Noncombustible fiber (polyester polyolefin) (EU-F7:EN779:2002)
PZ-25RFM-E	327	149	2	LGH-25RVX-E	
PZ-35RFM-E	393	175	2	LGH-35RVX-E	
PZ-50RFM-E	464	175	2	LGH-50RVX-E GUF-50RD(H)4	
PZ-65RFM-E	427	209	2	LGH-65RVX-E	
PZ-80RFM-E	446	236	2	LGH-80RVX-E LGH-150RVX-E(2sets)	
PZ-100RFM-E	559	236	2	LGH-100RVX-E GUF-100RD(H)4 LGH-200RVX-E(2sets)	

Optional Parts for VL-100(E)U₅-E

High performance filter P-100HF₅-E

Upgraded high-performance filter.

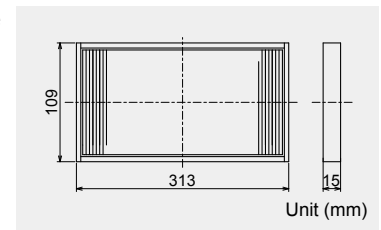

Extension pipe P-100P-E

Total length when connected to the pipe extension coupling is 300mm.

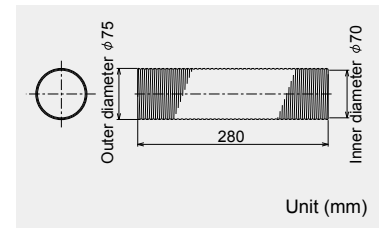

Replacement filter P-100F₅-E

Standard grade replacement filter.

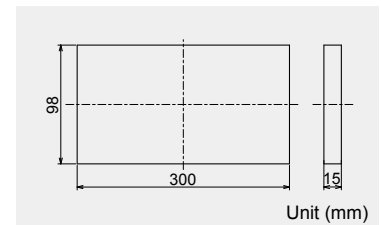

Extension pipe coupling P-100PJ-E

Screw-in method

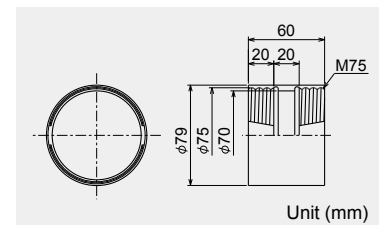

Air curtain



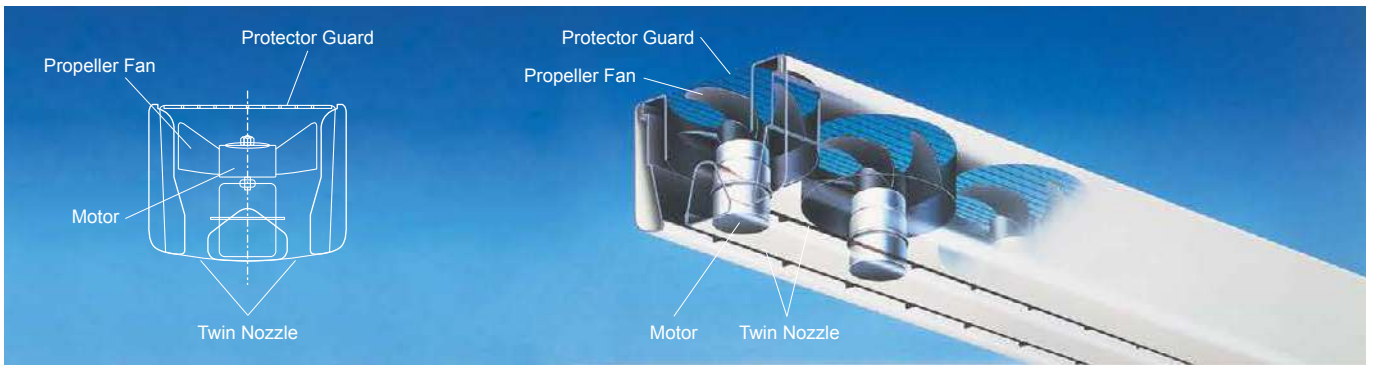

Quiet Propeller Design

Powerful airflow yet low noise

The hydromechanic technology applied to Mitsubishi Electric's Quiet Fan provides large airflow with low noise.



Low Energy Consumption

Our Quiet Fan has achieved major improvements in energy efficiency and operation cost compared to the previous model using a line flow fan.

Easy Maintenance

The use of axial Fan (quiet propeller design) makes the unit easier to maintain and keep the unit in top condition at all times.

Moreover, an improvement resulted from a change of fan from line flow fan to axial flow fan extends the life span of the unit.

Economic Benefits

Not only does the installation of an air curtain help to maintain a constant comfortable indoor temperature, it saves energy too.

Install an automatic door to achieve even more economical operation and a more pleasant indoor environment.

<Assumptions for economic benefits calculations>

- Environmental factors
 - Floor space 66.4m²
 - Temperature and humidity

(Assumptions)
This shop is housed in a two-story building. It is surrounded by other buildings on three sides: the back, the left and the right hand sides.

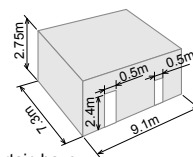

- Both the air conditioner and the air curtain have the specifications and characteristics of 50Hz.

		Cooling mode	Heating mode
Temperature	Indoor	28°C	18°C
	Outdoor	32°C	0°C
Humidity	Indoor	70%	-
	Outdoor	60%	-

Cooling mode

Economic benefits of installing an air curtain. (Savings are calculated using an appropriate cooling load factor to keep room temperature constant at 28°C in a room measuring 66.4m² in area.)

Cooling load factor and air curtain-shut-out effect (kW)	Cooling load factor
Open plan premises The doors are kept open and an air curtain is not used	29 kW
Premises with an air curtain installed Premises installed with either an air curtain or an automatic door	12.6 kW
Premises installed with both an air curtain and an automatic door	9.5 kW

Twin Nozzle

The twin nozzle design allows the Air Curtain to generate larger air-velocity distribution with less air intake.

Resistant to the influence of external airflow has been strengthened greatly improving insulation against heat and cold.

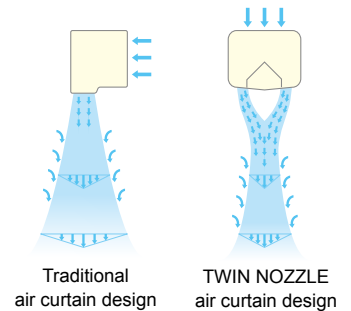

Flexible installation

The airflow angle can be adjusted both internally and externally.

The unit can be installed vertically or horizontally according to the available space.

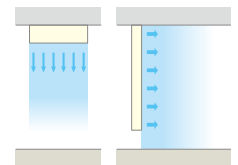

Heating mode

Economic benefits of installing an air curtain. (Savings are calculated using an appropriate heating load factor required to keep room temperature constant at 28°C for a room measuring 66.4m² in area.)

Heating load factor and air curtain shut-out effect (kW)	Heating load factor
Open plan premises The doors are kept open and an air curtain is not used	46.5 kW
Premises with an air curtain installed Premises installed with either an air curtain or an automatic door	20 kW
Premises installed with both an air curtain and an automatic door	11.5 kW

MODEL GK Series

Model	Fan speed	Single-phase,50Hz 220-240V					Single-phase,60Hz 220V					Starting Current (A)	Weight (kg)
		Air volume (m ³ /h)	Running current (A)	Input power (W)	Air velocity Max. (m/sec)	Noise (dB)	Air volume (m ³ /h)	Running current (A)	Input power (W)	Air velocity Max. (m/sec)	Noise (dB)		
GK-2509YS1-CE	High	1210-1230	0.25-0.26	54-61	9.5	43-44.5	1170	0.29	63	9.5	43	0.43	10.5
	Low	980-1000	0.24-0.25	52-59	7	38-41	930	0.25	54	7	35		
GK-2512AS1-CE	High	1420-1440	0.35-0.37	76-83	9.5	46-47	1410	0.39	84	9.5	46.5	0.62	13.3
	Low	1150-1170	0.31-0.33	67-78	7	40.5-44	1090	0.33	71	7	38		
GK-3009AS1-CE	High	1450-1470	0.43-0.46	90-105	12	46-47	1640	0.47	102	12	49.5	0.86	11.0
	Low	1100-1200	0.35-0.37	76-87	8	43-45.5	1150	0.39	84	8	42.5		
GK-3012AS1-CE	High	1740-1760	0.52-0.56	107-125	12	49-50	1950	0.58	125	12	52	1.05	14.0
	Low	1350-1400	0.44-0.46	95-109	8	46-47	1330	0.48	104	8	45		

*Use conditions: The temperature should be between -10 and +45°C. The RH should be less than 90% at room temperature. Any condition outside of this range could result in burnout, deformed, malrotating or damaged parts.

Dimensions

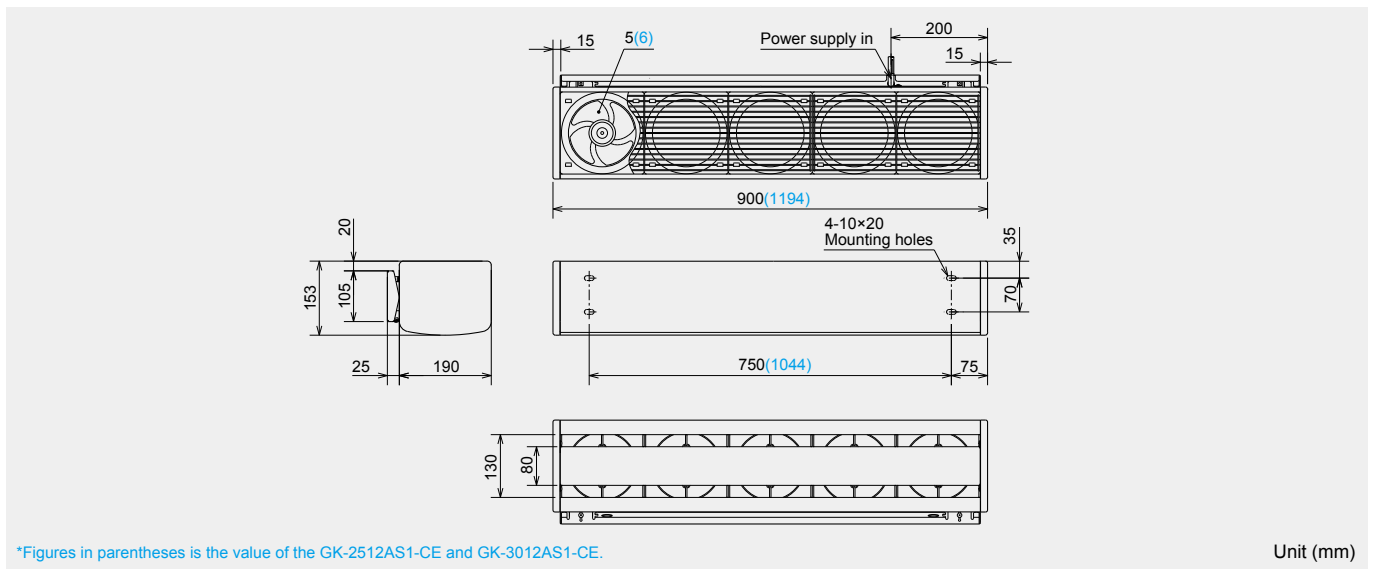

Air conducting fan



Features of Mitsubishi Electric Air Conducting Fan

Lower initial cost

Mitsubishi Electric's Air Conducting Fan eliminates the need for ducts, contributing to the reduction of initial cost.

More equipments and Higher installation cost

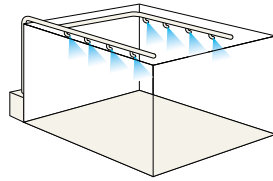

Less equipments and Lower installation cost

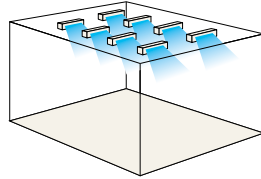

Simple Installation

Air Conducting Fan can be easily installed by simply mounting it to suspension bolts on the ceiling. The angle of air vent is adjustable to six levels.



Low Power Consumption

With the compact and high-efficiency motor, and also the axial fan (quiet propeller design). Air Conducting Fan saves a great deal of energy.

Quiet and Compact

The compact axial fan (quiet propeller design) reduces noise level yet still make it possible to achieve large airflow. The slim and lightweight design offers greater flexibility in your installation plans.

Installation examples for large spaces

Mitsubishi Electric Air Conducting Fans are used as supporting equipment for ventilators and air-conditioners in moving exhaust gas in car parks and improving the efficiency of ventilation or air-conditioning in factories and warehouses.

Car Parks : Removing exhaust gas

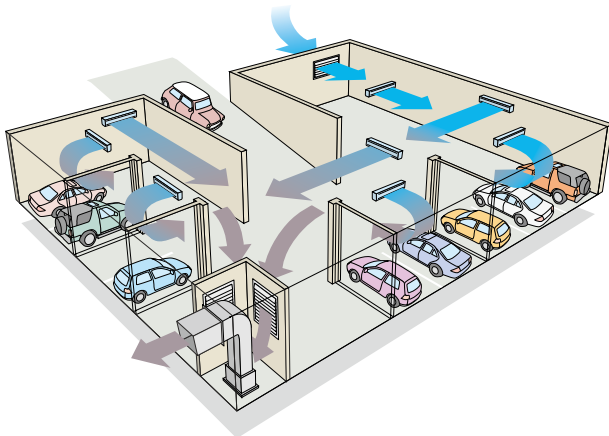

Air Conducting Fans are particularly useful for moving and expelling stagnant, dirty exhaust gas and hot air that stagnates in the midsections of buildings with complicated floor plans.

Warehouses and factories : Circulating Cool air

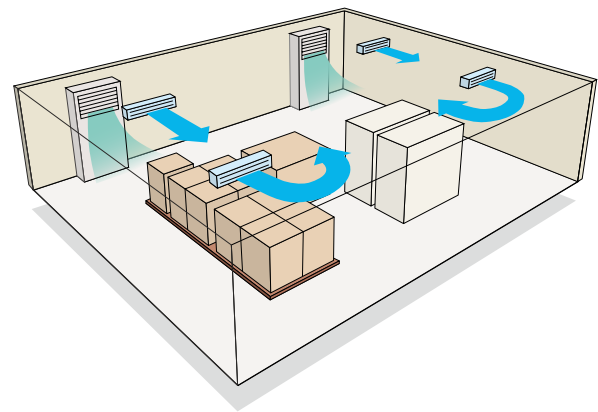

Since Air Conducting Fans help circulate air conditioned air, they improve the working environments by reducing temperature variations throughout large indoor spaces. They enhance effectiveness of cooling over a wider area, and the airflow they generate creates a refreshing breeze.

CO₂ distribution

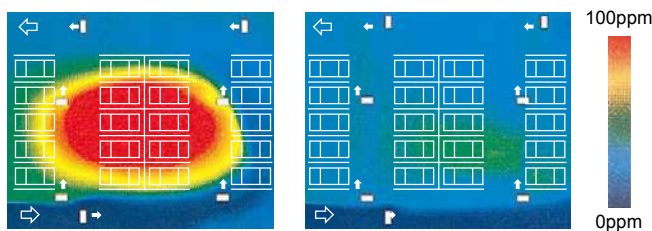

Air conducting fans not in use

Air conducting fans in use

The airflow created by Air Conducting Fans allows fresh air to permeate all corners of a car park while at the same time reliably directing the vehicle exhaust gas toward the exhaust fans.

Temperature distribution

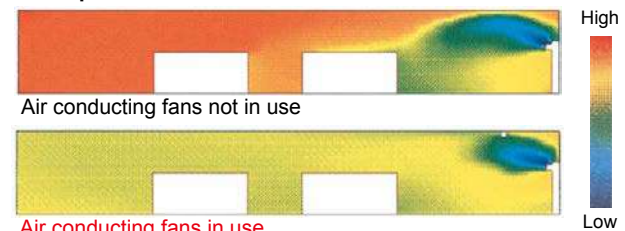

Air conducting fans in use

* Thermal distribution graphic for reference only. Actual results may differ.

Using Air Conducting Fans help the air-conditioned air to reach all corners, improving comfort levels throughout the area.

MODEL AH Series

Model	Fan speed	Single-phase, 50Hz 220-240V					Starting Current (A)	Weight (kg)
		Air volume (m ³ /h)	Running Current (A)	Input power (W)	Air velocity Max. (m/sec)	Noise (dB)		
AH-1006S-E	High	700-750	0.14-0.15	30-34	6.5-6.9	42-44	0.23	7
	Low	570-620	0.13-0.13	28-32	5.3-5.7	39-40		
AH-1509S-E	High	1180-1270	0.26-0.26	55-62	7.3-7.8	43.5-45	0.43	10.5
	Low	940-1040	0.24-0.25	51.5-59	5.8-6.4	39-41.5		
AH-2009S-E	High	1350-1400	0.43-0.47	90-105	8.3-8.6	46.5-47.5	0.85	11
	Low	1130-1200	0.36-0.37	77-87	7.0-7.4	44-46		
AH-3009S-E	High	2100	0.87-0.94	191-223	8.2	58-58	2.53	20.5
	Low	1860	0.74-0.75	150-165	7.3	55.5-56	1.55	

* The air volume given above is measured using the chamber method.(at 0pa)

* The sound level is measured dB (A range) at the point 1.5m of 45 degree from center point of supply opening.

Dimensions of the AH-1006/1509/2009S-E

* The mounting angle of the unit body can be adjusted in 8 steps.
(0, 11.3, 22.5, 33.8, 45, 56.3, 67.5, 90°)

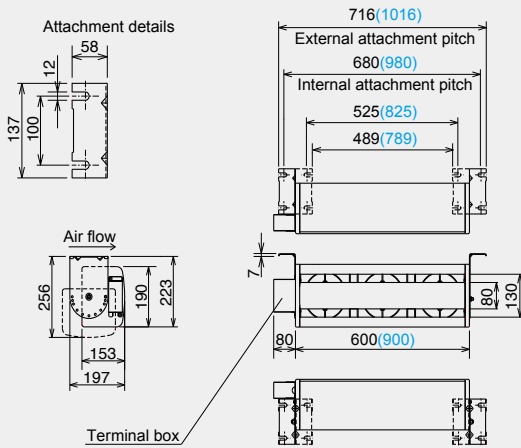

*Figures in partenthesis is the value of the AH-1509S-E and AH-2009S-E. Unit (mm)

Dimensions of the AH-3009S-E

* The mounting angle of the unit body can be adjusted in 8 steps.
(0, 11.3, 22.5, 33.8, 45, 56.3, 67.5, 90°)

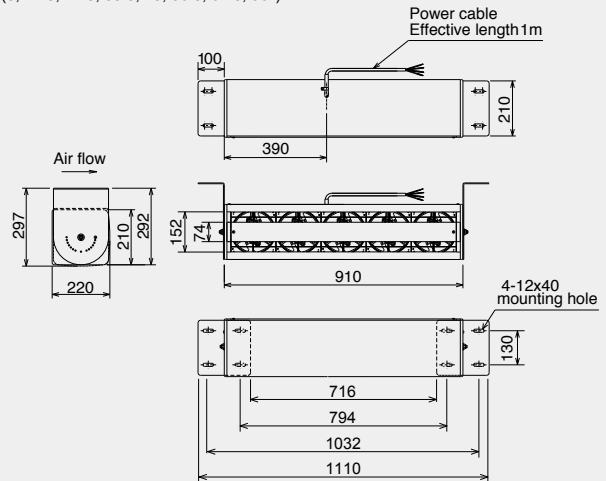

*Figures in partenthesis is the value of the AH-3009S-E. Unit (mm)

Results of Noise Analysis

Background noise : 25dB or less (A range) Measurement site : Anechoic chamber Measurement point 1.5m 45°

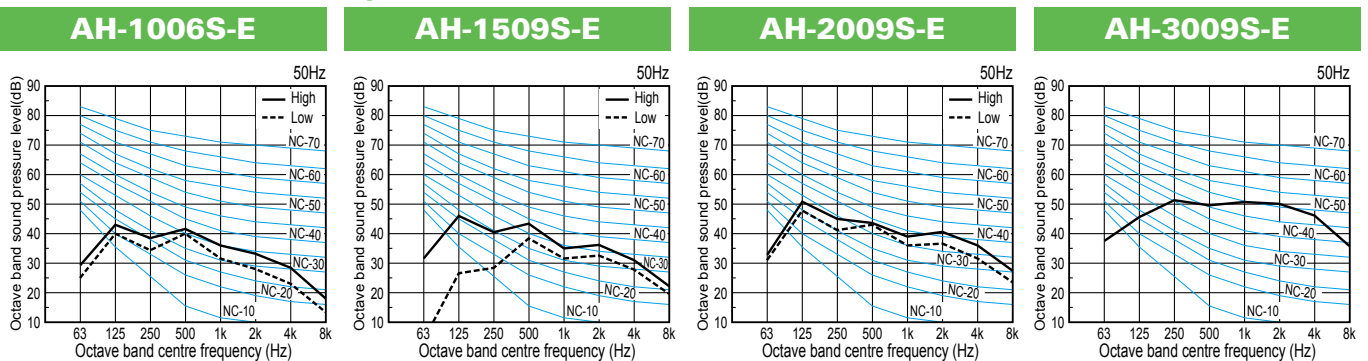

Air conducting fan

Wind velocity distribution

AH-1006S-E

High speed

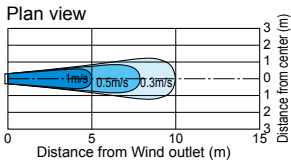

Low speed

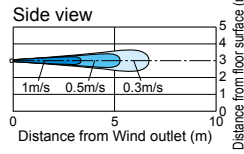
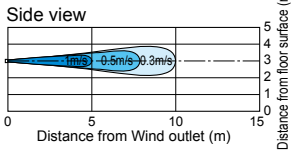
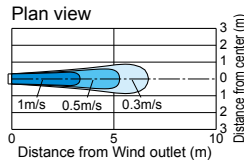

AH-1509S-E

High speed

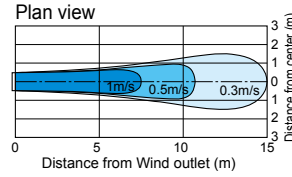

Low speed

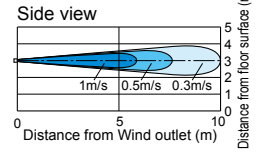
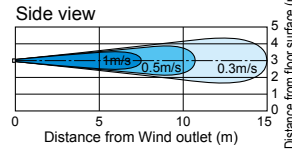
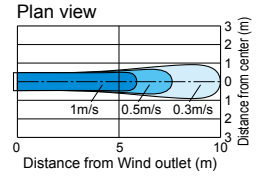

AH-2009S-E

High speed

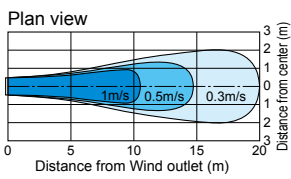

Low speed

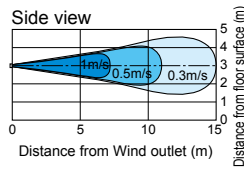
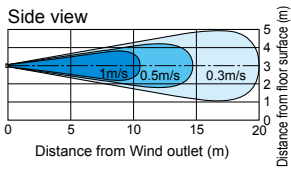
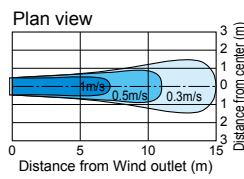

AH-3009S-E

High speed

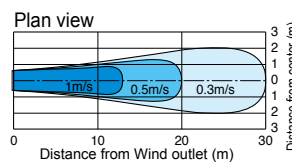

Low speed

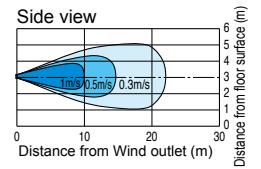
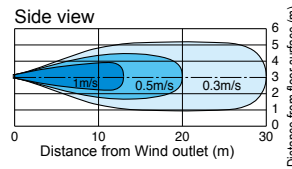
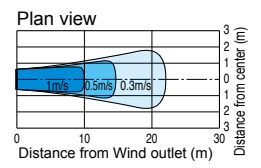

Installation guideline

Effective range for one air conducting fan.

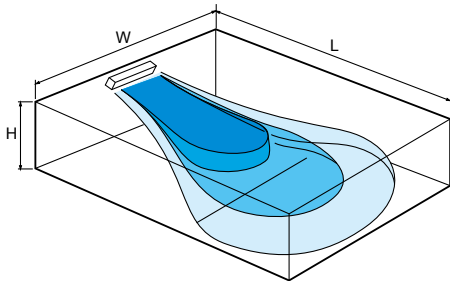

Unit (mm)

Model	L	W	H
AH-1006S-E	5 - 10	4 - 6	2 - 4
AH-1509S-E	10 - 15	5 - 7	3 - 6
AH-2009S-E	15 - 20	6 - 8	4 - 8
AH-3009S-E	20 - 30	7 - 9	5 - 10

- There are cases where the reach distance is extended by angled venting, which causes the Wind to flow along the floor's surface.
- The Wind velocity distribution may be disturbed by enclosing walls, beams, pillars and other obstructions.
- Depending on conditions of the building, there may be difference in the spacing of units during installation.

Jet Towel



Since developing the world's first high-speed hand dryer in 1993, Mitsubishi Electric has continued to improve technologies and services focusing on ease of use for our customers.



Feature of the Mitsubishi Electric Jet Towel

For the Environment No Waste Paper

The high-speed Jet Towel™ hand dryer uses jet streams of air to dry hands, eliminating the paper waste associated with the use of paper towels, and thus relieving you of the trouble of waste disposal as well. The preservation of forest resources will also contribute to enhancing your corporate image.

No. of paper towels made from one tree

1 tree (8m high, 14cm dia.) = **Approx. 20,000 paper towels** (2-month supply for 1 dispenser: 2 towels each time, 200 times/day)

Example: Company A (10-story building)

<p>■ Paper towel used</p> <p>Approx. 320,000 sheets/month</p>	<p>■ Paper towel used</p> <p>Approx. 13,000 sheets/day</p> <p>= 64 bags of waste/day! (Assuming 200 paper towels/bag)</p>
--	---

*Survey conducted by Mitsubishi Electric

*Many paper towels are made from recycled paper, so it does not necessarily lead to environmental destruction.

For Corporate Management Substantial Cost Reduction

The monthly expense is reduced to a fraction of the cost in comparison to paper towels or rolled-cloth towels. The higher the use, the greater the savings.

Uses per day	Unit: ¥			
	100 uses	200 uses	300 uses	400 uses
Paper towels	5,000	10,000	15,000	20,000
Cloth-roll towels	7,500	15,000	22,500	30,000
JT-SB216JSH2	Heater on	252	484	716
	Heater off	181	343	505
JT-SB216KSN2	181	343	505	667

<Calculation conditions>
 *Used 25 days per month
 Jet Towel: Heater on for 10sec., off for 12sec. per use; constantly on (1 day = 24hr; 1mo = 30d); Electricity cost of (¥) 27 yen/kWh
 Paper towels: Paper cost of (¥) 1 yen per sheet; 2 sheets per use
 Cloth-roll towels: Rental fee of (¥) 600 yen per roll; 200 uses per roll

For Building Management Easy Maintenance

The only maintenance required is clean the air filter and removing water from the drain tank*. Save time by eliminating the daily replenishment of paper towels, disposal of paper waste and replacing cloth-roll towels.

*Tank must also be cleaned.



For Customers Improved Service

Evaluated highly for its sanitary characteristics, the Jet Towel is popular among facilities and shops alike. In addition to its ability to dry hands completely in a matter of seconds and offer a clean sanitary environment for customers, maintenance and running costs are minimized for maximum cost efficiency. The result is enhanced customer service.



Innovating the modern hand dryer since 1993

Jet Towel Slim

- Amazingly quiet at 56dB*³! 2 dB less than previous model
- Stronger front and back panels for greater impact resistance
- Switches moved internally to prevent unauthorized tampering



Model		Jet Towel Slim (With heater)		Jet Towel Slim (No Heater)	
		JT-SB216JSH2	JT-SB216KSN2	High Power	Standard
Drying Time ^{*1} (S)	Heater On	9-11	11-13	—	—
	Heater Off	11-13	13-15	11-13	13-15
Noise ^{*2} (dB)		59	56	59	56
Wattage(W)	Heater On	1240	1070	—	—
	Heater Off	720	550	720	550
Hygienic Features		• NSF 169 Certification • Antibacterial Surfaces • Alcohol-cleanable Excluding panel of JT-SB216JSH2-S-NE			
Safety Features		• Thermal Fuse • Current Fuse			
Size (w x h x d)(mm)		300 x 670 x 219			
Weight(kg)		11			

(JT-SB216KSN2 model available only in white)

*1 Time needed to reduce remaining water to 50mg or less per hand (in-house study).

*2 Measurements made in anechoic chamber at a distance of 2m.

*3 Standard

Jet Towel Smart

- High speed drying with low energy use and quiet operation
- Robust, tamper-resistant body (JT-S2AP equipped with metal panel)
- 0.1 second quick response improves user drying experience



Model		Jet Towel Smart (with heater)		Jet Towel Smart Lite (No heater)	
		JT-S2AP	JT-S2A	High Power	Standard
Drying Time ^{*4} (S)	Heater On	9-12	14-16	—	—
	Heater Off	10-13	15-17	10-13	15-17
Noise ^{*5} (dB)		60-62	58-59	60-62	58-59
Wattage(W)	Heater On	880-980	660-740	—	—
	Heater Off	630-730	410-490	630-730	410-490
Hygienic Features		• NSF 169 Certification • Antibacterial Surfaces • Alcohol-cleanable Excluding panel of JT-S2AP			
Safety Features		• Thermal Fuse • Current Fuse			
Size (w x h x d)(mm)		250 x 290 x 160		250 x 292 x 162	
Weight(kg)		4.5		4	

(JT-S2A model available only in white)

*4 Time needed to reduce remaining water to 50mg or less per hand (in-house study).

*5 Measurements made in anechoic chamber at a distance of 2m.



Custom color options available!

The Jet Towel Smart / Smart Lite can be specially color-customized for large orders. Your logo can also be added to the unit for a unique look. A great way to promote your business and catch attention.

*Contact your local Mitsubishi Electric sales office for details.



Jet Towel Mini

- Low energy use and quiet operation
- Compact yet spacious and easy to use
- Easy to clean and hygienic



Model		Jet Towel Mini (with heater)	
		JT-MC206GS	
		High Power	Low Power
Drying Time ^{*6} (S)	Heater On	13-15	
	Heater Off	24-27	
Noise ^{*7} (dB)		62-64	52-54
Wattage(W)	Heater On	735-825	390-455
	Heater Off	475-560	175-220
Hygienic Features		• Antibacterial Surfaces • Alcohol-cleanable	
Safety Features		• Thermal Fuse • Current Fuse	
Size (w x h x d)(mm)		250 x 480 x 170	
Weight(kg)		5	

*6 Time needed to reduce remaining water to 50mg or less per hand (in-house study).

*7 Measurements made in anechoic chamber at a distance of 2m.

• Certain ratings and specifications may change due to product improvements or modifications. • Refer to the product manuals for safety precautions.



for a greener tomorrow

Eco Changes is the Mitsubishi Electric Group's environmental statement, and expresses the Group's stance on environmental management. Through a wide range of businesses, we are helping contribute to the realization of a sustainable society.



mitsubishi electric corporation

HEAD OFFICE : TOKYO BLDG., 2-7-3 MARUNOUCHI, CHIYODA-KU, TOKYO 100-8310, JAPAN
www.MitsubishiElectric.com