

Comfort & IT Cooling systems

Full product catalogue 2022-2023

VRF & HVRF Systems, Heating, Ventilation,
Control Systems, Hydronic and IT Cooling systems



LIVING ENVIRONMENTAL SYSTEMS

Comfort e It Cooling Systems



VRF System

03-147



HVRF System

148-207



Heating

208-233



Ventilation

234-253



Control Systems

254-291



Chiller

292-339



IT Cooling

340-364

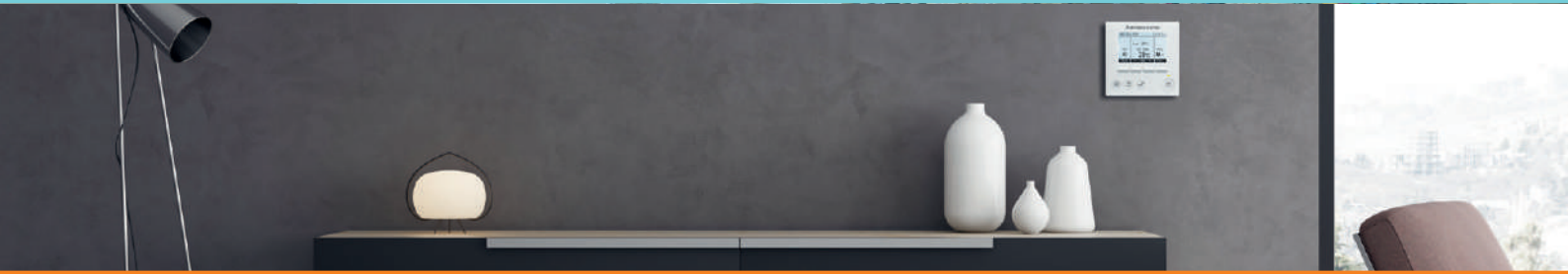



VRF-HVRF System CITY MULTI: innovation 2022

New outdoor unit PUMY P250/300 YBM

The SMALL Y Line gets enriched by the addition of new models (10 and 12HP) in response to the increasing market need for a compact machine that covers bigger capacity. The PUMY P250/300 YBM outdoor units are available in a single version with three-phase power supply, double fan structure, side-flow and with different sizes depending on the model. Also available in -BS version, with anti-saline treatment.

New Remote Controller PAR-41MAA

New Model replace PAR-41MAA, the news are:

- **Backlit LCD**
- **Large, easy-to-see display**
The screen background can be changed to black to suit the ambience of the room.
- **3D i-see sensor ***
Setting for 3D i-see sensor can be performed.
- **Draft reduction ***
“Close” has been added to the manual vane angle selection. The air outlet can be closed to reduce drafts from the air conditioner

CITY MULTI	
OUTDOOR UNIT PUMY P250/300 YBM	PAR-41MAA



New HVRF Y Hydronic Packaged systems

The packaged hydronic system HVRF Y, in heat pump is an hydronic solution consisting of a production section water composed of an Outdoor I unit of VRF technology Y t series and a hydronic unit from which the water distribution.

The system is completed by hydronic terminals of different types and sizes, from the native adjustment in the field.

All the components of the hydronic system mentioned above are Mitsubishi Electric branded.

The HVRF Y systems are low environmental pollution with an important reduction of CO₂ equivalent, thanks to the use of R32 refrigerant gas, with low GWP.

New HVRF indoor units W/WL series

Ceiling concealed

PEFY-W VMS-A Medium to low static pressure
PEFY-W VMA-A Medium to high static pressure

Ceiling cassette

PLFY-WL VEM-E 4 way airflow type
PLFY-WL VEM-E 4 way airflow compact type

Floor standing

PFFY-W VCM-A

Wall mounted

PKFY-WL VLM-E

This models are compatible with HVRF R2/ Y systems

NEW HVRF Y HYDRONIC PACKAGED SYSTEMS



NEW HVRF INDOOR UNITS W/WL SERIES





VRF System

System types



SMALL Y AND SMALL Y COMPACT LINES
(SMALL SYSTEM)

Y LINE
(HEAT PUMP)

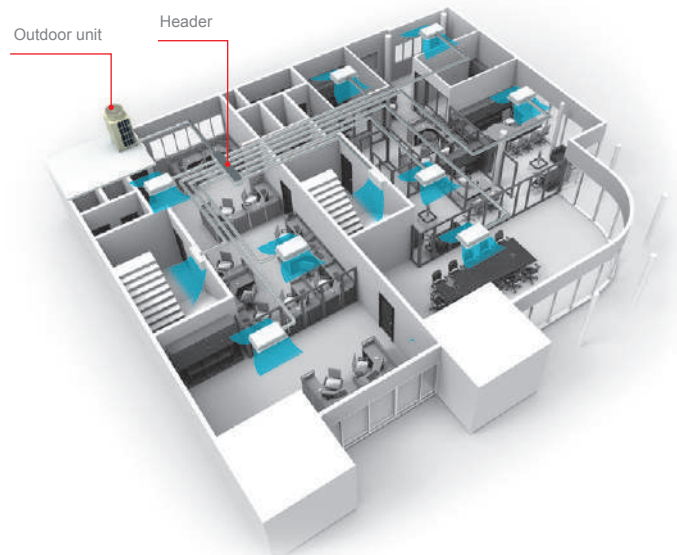
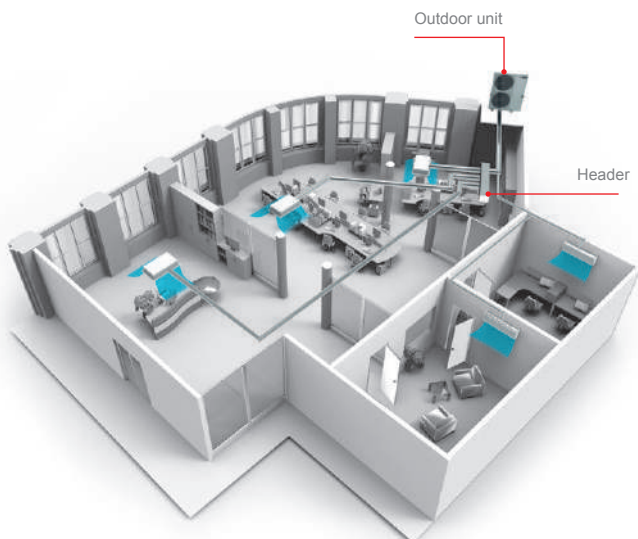

Y Line

The two-pipe zoned system designed for Heat Pump Operation

The CITY MULTI Small lines (for small applications) and Y lines (for large applications) make use of a two-pipe refrigerant system, which allows for system changeover from cooling to heating, ensuring that a constant indoor climate is maintained in all zones. The compact outdoor unit utilizes R410A refrigerant and an INVERTER-driven compressor to use energy effectively. With a wide line-up of indoor units in connection with a flexible piping system, the CITY MULTI series can be configured for all applications. Up to 11 (Small line) or 50 (Y line) indoor units can be connected with up to 130% connected capacity to maximize engineer's design options. This feature allows easy air conditioning in each area with convenient individual controllers.

R2 Line

The world's first two-pipe system that Simultaneously Cools and Heats

CITY MULTI R2 line offers the ultimate in freedom and flexibility. Cool one zone while heating another. Our exclusive BC controller makes two-pipe simultaneous cooling and heating possible. The BC controller is the technological heart of the CITY MULTI R2 series. It houses a liquid and gas separator, allowing the outdoor unit to deliver a mixture of hot gas for heating and liquid for cooling, all through the same pipe. This innovation results in virtually no energy wasted by being expelled outdoors. Depending on capacity, up to 50 indoor units can be connected with up to 150% connected capacity.

Y LINE AIR CONDENSED HEAT PUMP

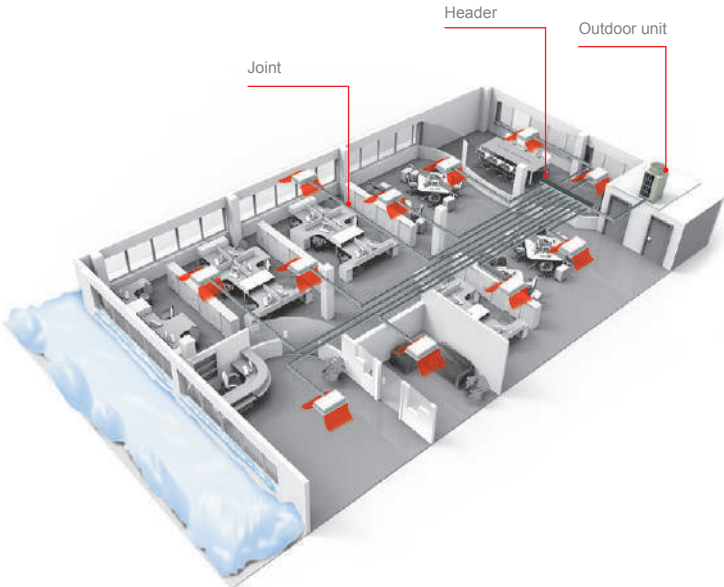

R2 LINE AIR CONDENSED RECOVERY HEAT PUMP SIMULTANEOUSLY HEATING AND COOLING

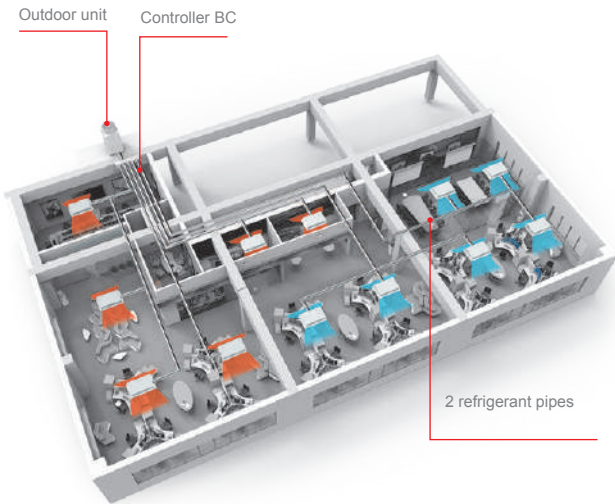

WY Line

Water energy source system allows switching between cooling and heating

The WY-Line has all the benefits of the Y-Series using water source condensing units. Condensing units can be situated indoors allowing greater design flexibility and no limitation on building size. Depending on capacity, up to 17 to 50 indoor units can be connected to a single condensing unit with individualized and/or centralized control. The two-pipe system allows all CITY MULTI solutions to switch between cooling and heating while maintaining a constant indoor temperature.

WR2 Line

Advanced water heat source unit enjoying the benefits of R2 series

The CITY MULTI WR2 line provides all of the advantages of the R2 series with the added advantages of a water heat source system, making it suitable for wider range of applications in high rises, frigid climates, coastal areas, etc. Not only does it produce heat recovery from the indoor units on the same 2-pipe refrigerant circuit, it also produces heat recovery via the water circuit between heat source units, making it a very economical system.

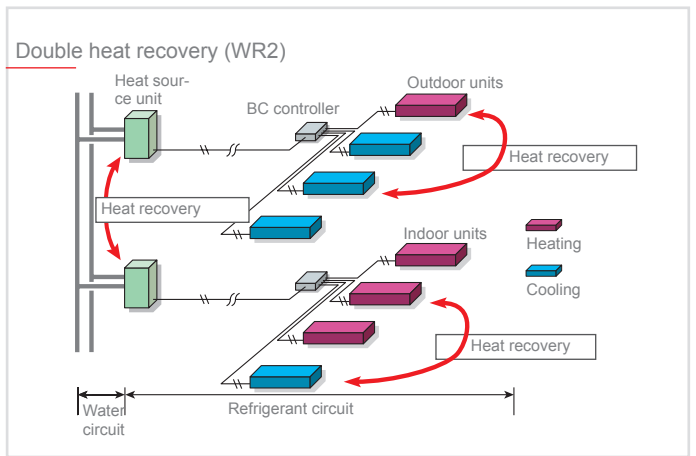

WY LINE
WATER CONDENSED HEAT PUMP

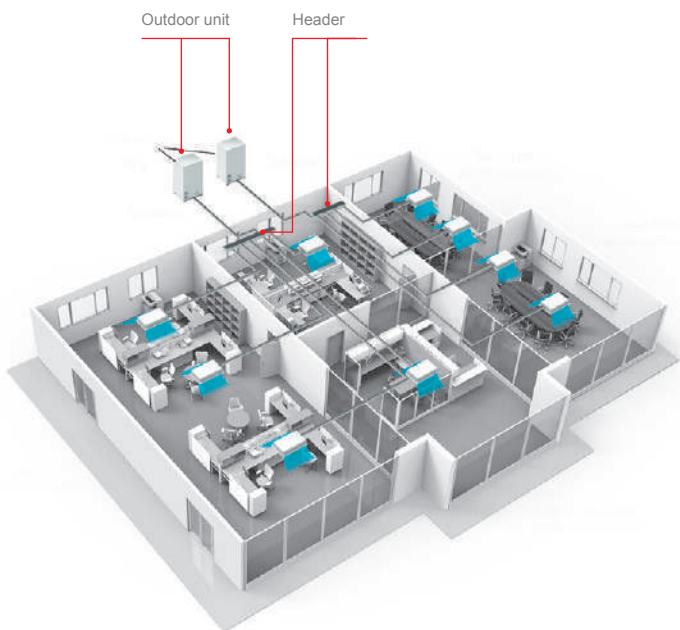



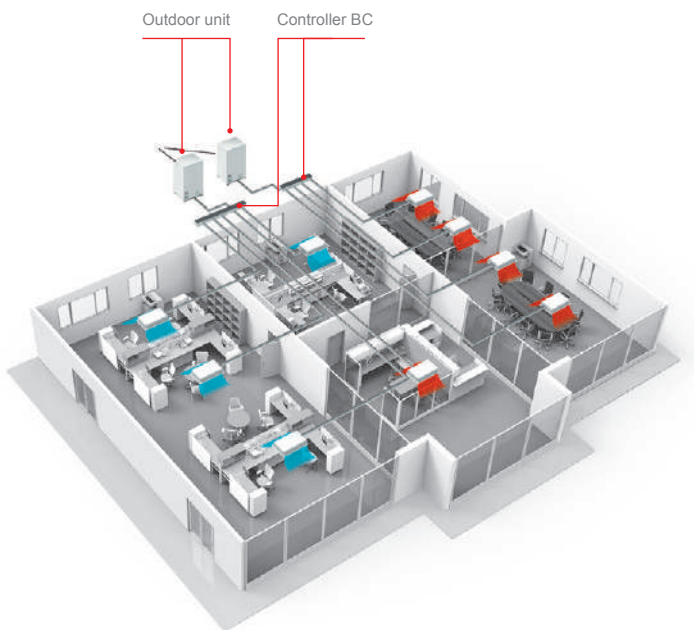



WR2 LINE SIMULTANEOUSLY HEATING AND COOLING WATER CONDENSED





	<p>CITY MULTI SMALL Y SMALL Y COMPACT SYSTEM SMALL Y -HIGH CAPACITY- LINE</p>	<p>Compact heat pump systems</p>
	<p>CITY MULTI Y ECOSTANDARD SYSTEM</p>	<p>Heat pump systems optimized for cooling operation</p>
	<p>CITY MULTI Y HIGH EFFICIENCY SYSTEM</p>	<p>High efficiency heat pump systems with continuous heating</p>
	<p>CITY MULTI Y NEXT STAGE SYSTEM</p>	<p>Heat pump systems with continuous heating</p>
	<p>CITY MULTI Y NEXT STAGE HIGH EFFICIENCY SYSTEM</p>	<p>High efficiency heat pump systems with continuous heating</p>
	<p>CITY MULTI WY SYSTEM</p>	<p>Water condensed Heat Pump systems</p>
	<p>CITY MULTI R2 NEXT STAGE SYSTEM</p>	<p>Two-pipes Cooling / Heating simultaneous systems with heat recovery and continuous heating</p>
	<p>CITY MULTI R2 NEXT STAGE HIGH EFFICIENCY SYSTEM</p>	<p>High Efficiency two-pipes Cooling / Heating simultaneous systems with heat recovery and continuous heating</p>
	<p>CITY MULTI WR2 SYSTEM</p>	<p>Water condensed Heat Recovery systems</p>

	<p>SINGLE PHASE PUMY-SP VKM (-BS) - HP 4,5-6 PUMY-P VKM (-BS) - HP 4,5-6 THREE PHASE PUMY-P YKM (-BS) - HP 4,5-8 PUMY-P YBM (-BS) - HP 10,12</p>
	<p>SINGLE Y PUHY-P YKA (-BS) - HP 8~20 DOUBLE Y PUHY-P YKA (-BS) - HP 22~40 LARGE Y PUHY-P YSKA (-BS) - HP 42~60</p>
	<p>SINGLE Y PUHY-EP YLM-A1 (BS) - HP 8~20 DOUBLE Y PUHY-EP YSLM-A1 (-BS) - HP 22~24 TRIPLE Y PUHY-EP YSLM-A1 (-BS) - HP 26~54</p>
	<p>SINGLE Y PUHY-P YNW-A1 (-BS) - HP 8~20 DOUBLE Y PUHY-P YSNW-A1 (-BS) - HP 16~36 TRIPLE Y PUHY-P YSNW-A1 (-BS) - HP 38~54</p>
	<p>SINGLE Y PUHY-EP YNW-A1 (-BS) - HP 8~20 DOUBLE Y PUHY-EP YSNW-A1 (-BS) - HP 16~36 TRIPLE Y PUHY-EP YSNW-A1 (-BS) - HP 38~54</p>
	<p>SINGLE WY PQHY-P YLM-A1 - HP 8~24 DOUBLE WY PQHY-P YSLM-A1 - HP 16~36</p>
	<p>SINGLE R2 PURY-P YNW-A1 (-BS) - HP 8~22 DOUBLE R2 PURY-P YNW-A1 (-BS) - HP 16~44</p>
	<p>SINGLE R2 PURY-EP YNW-A1 (-BS) - HP 8~22 DOUBLE R2 PURY-EP YNW-A1 (-BS) - HP 16~44</p>
	<p>SINGLE WR2 PQRV-P YLM-A1 - HP 8~24 DOUBLE WR2 PQRV-P YSLM-A1 - HP 16~36</p>

System				HP	4,5	5	6	8	10	12	14	16
				Model	P112	P125	P140	P200	P250	P300	P350	P400
Air condensed	Heat pump Small Y Line Small Y Compact Line Small Y -High Capacity- Line	PUMY-P Y(V)KM (-BS) PUMY-SP VKM (-BS) PUMY-P YBM (-BS)		Single phase	4,5	5	6					
				Three phase	4,5	5	6	8	10	12		
	Ecostandard Y Line	PUHY-P YKA(-BS) PUHY-P YSKA(-BS)		SINGLE				8	10	12	14	16
				DOUBLE								
				TRIPLE								
	Heat pump High Efficiency Y Line	PUHY-EP YLM-A1(-BS) PUHY-EP YSLM-A1(-BS)		SINGLE				8	10	12	14	16
				DOUBLE								
				TRIPLE								
	Heat pump Y Next Stage Line	PUHY-P YNW-A1(-BS) PUHY-P YSNW-A1(-BS)		SINGLE				8	10	12	14	16
				DOUBLE								8+8
				TRIPLE								
	Heat pump High Efficiency Y Next Stage Line	PUHY-EP YNW-A1(-BS) PUHY-EP YSNW-A1(-BS)		SINGLE				8	10	12	14	16
				DOUBLE								8+8
				TRIPLE								
Heat recovery R2 Next Stage Line	PURY-P YNW-A1(-BS) PURY-P YSNW-A1(-BS)		SINGLE				8	10	12	14	16	
			DOUBLE								8+8	
High Efficiency Heat recovery R2 Next Stage Line	PURY-EP YNW-A1(-BS) PURY-EP YSNW-A1(-BS)		SINGLE				8	10	12	14	16	
			DOUBLE								8+8	
Water condensed	Heat pump WY Line	PQHY-P YLM-A1 PQHY-P YSLM-A1		SINGLE				8	10	12	14	16
				DOUBLE								8+8
	Heat recovery WR2 Line	PQRY-P YLM-A1 PQRY-P YSLM-A1		SINGLE				8	10	12	14	16
				DOUBLE								8+8

	18	20	22	24	26	28	30	32	34	36	38	40	42	44	46	48	50	52	54	56	58	60	
	P450	P500	P550	P600	P650	P700	P750	P800	P850	P900	P950	P1000	P1050	P1100	P1150	P1200	P1250	P1300	P1350	P1400	P1450	P1500	
	18	20																					
			10+12	10+14	10+16	10+18	12+18	16+16	16+18	18+18	18+20	20+20											
													12+12 +18	12+14 +18	14+16 +16	16+16 +16	16+16 +18	16+18 +18	18+18 +18	18+18 +20	18+20 +20	20+20 +20	
	18	20																					
			10+12	12+12																			
					8+8 +10	8+8 +12	8+10 +12	8+12 +12	10+12 +12	12+12 +12	12+12 +14	12+12 +16	12+14 +16	14+14 +16	14+14 +18	14+16 +18	14+18 +18	16+18 +18	18+18 +18				
	18	20																					
	8+10	10+10	10+12	12+12	10+16	14+14	14+16	14+18	16+18	18+18													
											10+14 +14	10+14 +16	10+16 +16	14+14 +16	14+16 +16	16+16 +16	16+16 +18	16+18 +18	18+18 +18				
	18	20																					
	8+10	10+10	10+12	12+12	10+16	14+14	14+16	14+18	16+18	18+18													
											10+14 +14	10+14 +16	10+16 +16	14+14 +16	14+16 +16	16+16 +16	16+16 +18	16+18 +18	18+18 +18				
	18	20	22																				
	8+10	10+10	10+12	12+12	12+14	14+14	14+16	16+16	16+18	18+18	18+20	20+20	20+22	22+22									
	18	20	22																				
	8+10	10+10	10+12	12+12	12+14	14+14	14+16	16+16	16+18	18+18	18+20	20+20	20+22	22+22									
	18	20	22	24																			
	8+10	10+10	10+12	12+12		14+14	14+16	16+16	16+18	18+18													
	18	20	22	24																			
	8+10	10+10	10+12	12+12		14+14	14+16	16+16	16+18	18+18													



Key Technologies

Mitsubishi Electric: state of the art technology and continuous pursuit of improvement. Quality, innovation and performance of VRF CITY MULTI systems.

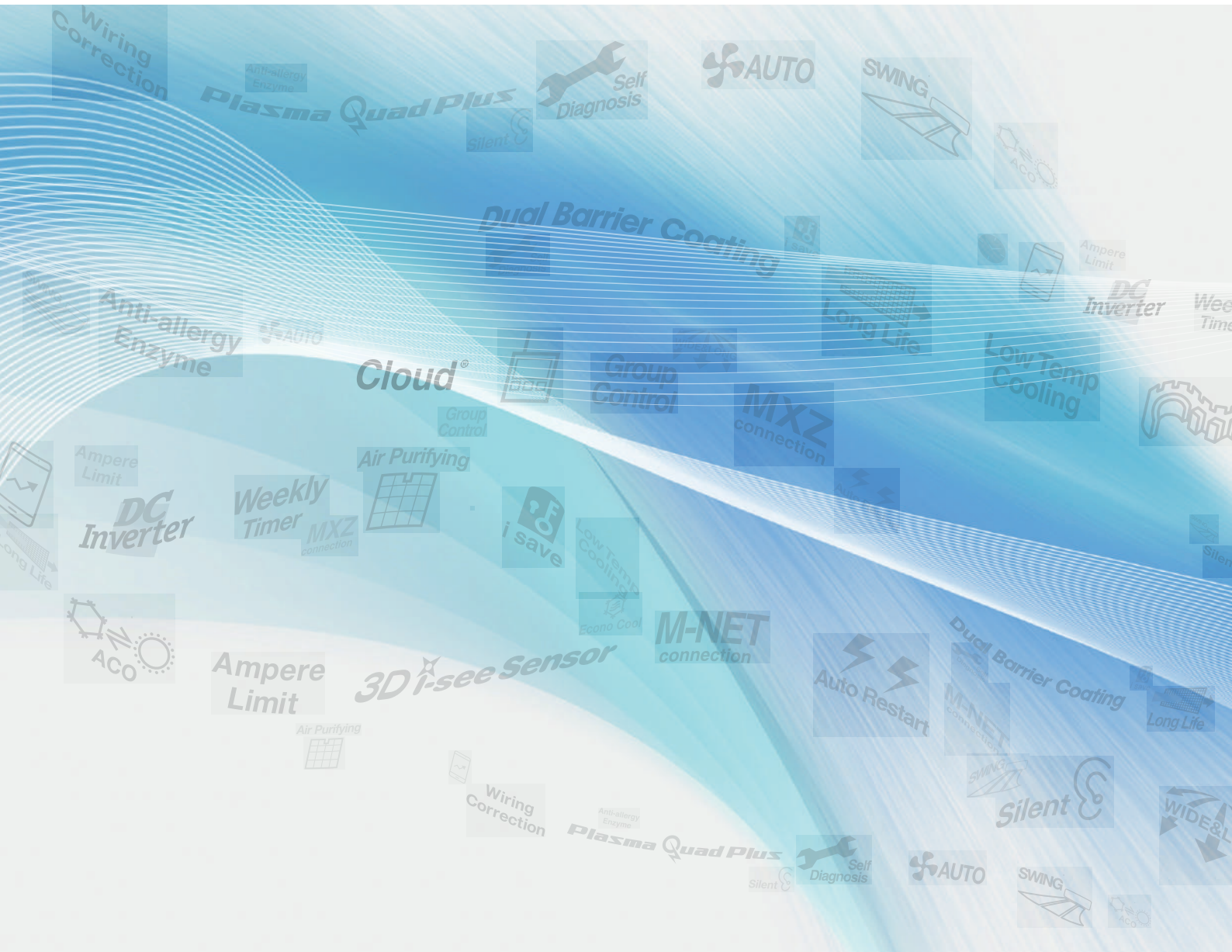

Technology

NEW **NEXT STAGE generation** **New compressor NEXT STAGE GENERATION**

The compressor, known as the heart of the air conditioner, has been newly developed. A new centrifugal force canceling mechanism and a new multi-port mechanism have been developed. In addition, we have mounted a high-efficiency motor. The synergetic effect of these new technologies increases the compressor performance and efficiency, and also helps to improve the performance of the outdoor unit.



Centrifugal force canceling mechanism (8 to 14HP)

The structure of the scroll compressor causes a centrifugal force during operation. Conventionally, that centrifugal force is applied onto the scroll section.

This causes refrigerant to leak, and restricts the increase in rotational speed to a maximum of 120rps.

With the new compressor, a new structure (centrifugal force canceling mechanism) has been mounted to suppress the centrifugal force. This mechanism successfully suppresses the centrifugal force generated at the scroll section, reduces refrigerant leakage losses, and increases the compressor efficiency. The maximum rotational speed has been increased from the conventional 120rps to 140rps.

This new mechanism also speeds up the start of operation, and enables operations such as preheat defrost operation and the smooth auto-shift startup mode.

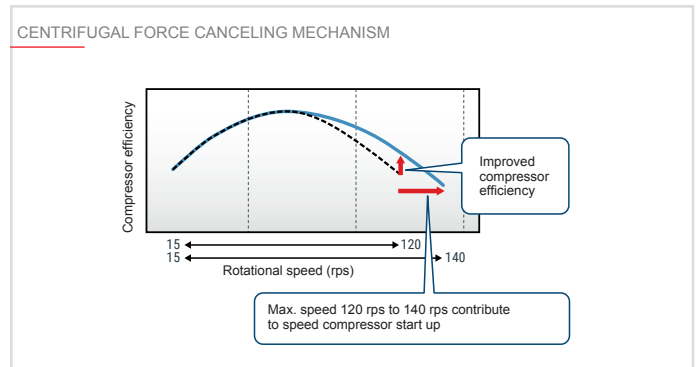
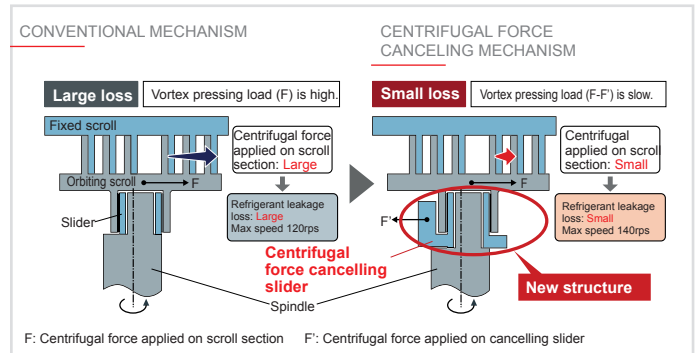

Multi-port mechanism

Efficient partial load operation is realised by avoiding over-compression. With the scroll compressor, the distance of the compression process in the scroll is usually fixed, so over-compression occurs during low loads and low rotation. The new compressor is equipped two sub-ports in addition to the conventional discharge port to reduce this over-compression loss during low loads. In operation conditions having a low compression rate, the distance in the compression process is kept short by that successfully avoiding unnecessary compression, and contributing to efficient partial load operation.

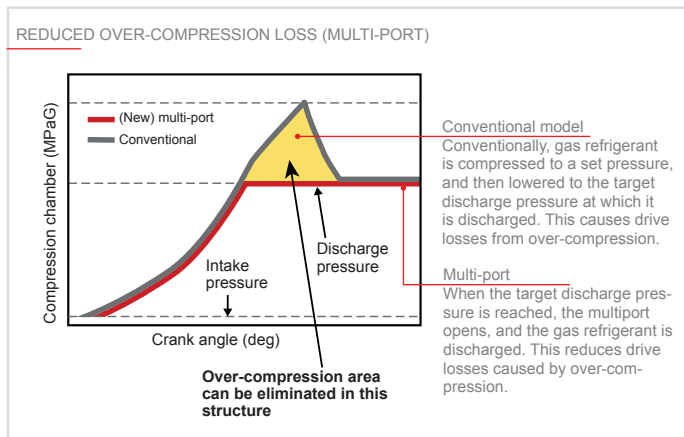
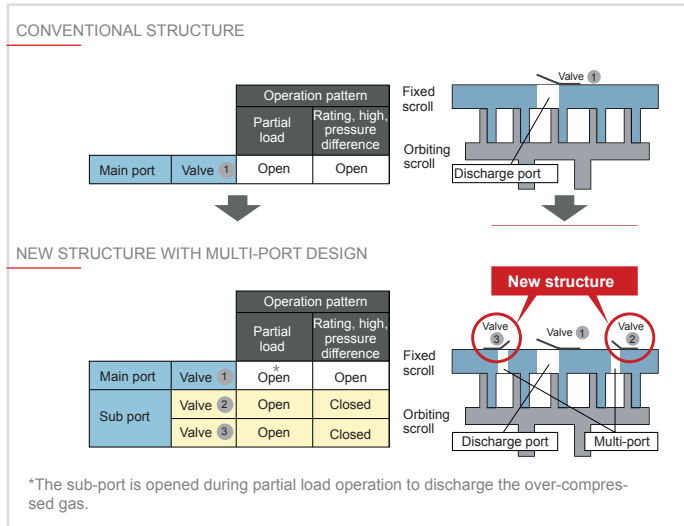

Improved high-efficiency motor

The insulator section that traditionally created a dead space is eliminated by insulating the motor's stator film. Since winding can be set in that section, the winding area can be increased by approx. 9%. The wire diameter has also been increased by two ranks, so the resistance between terminals is reduced, and the insulation distance is shorter. This improves the motor's operation performance and contributes to high-efficiency operation of the compressor.

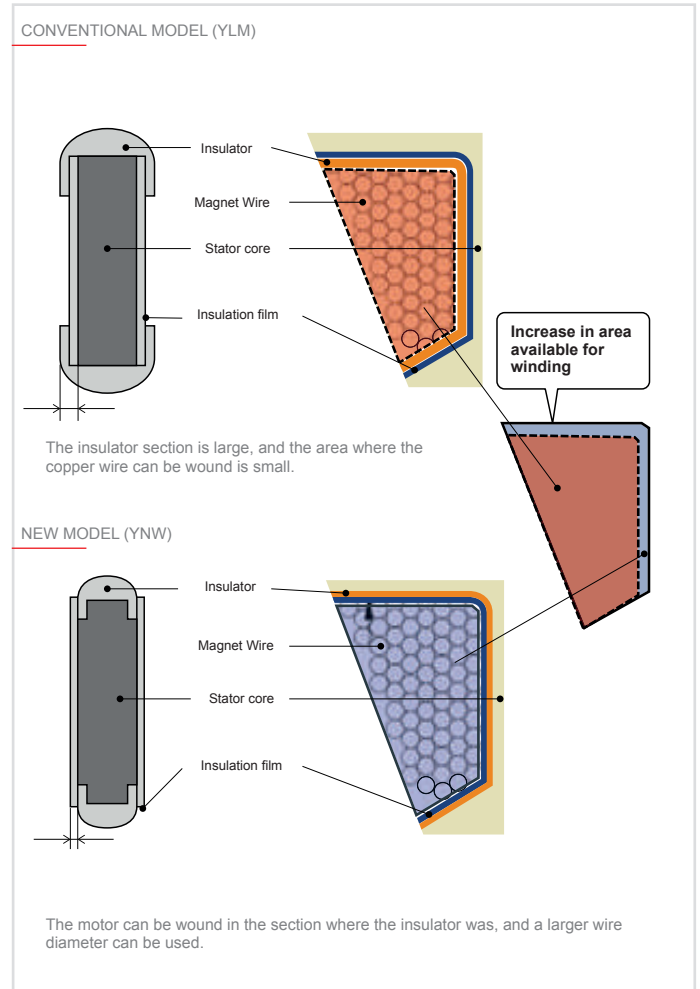

Flat tube

FLAT TUBE thermal exchange coil

With the new **Y High Efficiency and R2 High Efficiency lines** of outdoor units, Mitsubishi Electric has also introduced the new FLAT TUBE all-aluminium thermal exchange coil. The new solution, which is covered by global patents, sets new standards for heating and cooling performance while also reducing the overall size of the machine.

The FLAT TUBE technology coil – also known as a “micro-channel heat exchanger” – consists of three components: the flat tubing, the internal fins forming the micro-channels, and two refrigerant fluid collector boxes.

This type of heat exchanger was used for the first time in around 2008 in the automotive industry. With its globally patented FLAT TUBE system, Mitsubishi Electric has further developed this technology to offer even more advantages.

Unparalleled quality, efficiency and product integrity are the tangible results of a production process based on a single brazing stage instead of the 200-300 manually brazed individual connections necessary with a conventional copper/aluminium coil. Moreover, the FLAT TUBE heat exchanger requires a smaller

charge volume than a conventional bi-metal coil, as the microchannels limit the available volume for the refrigerant fluid while also creating a larger thermal exchange surface area.

Weather resistance is a key factor for the heat exchanger coil, as it is perhaps the component that is most exposed to the harmful effects of the atmosphere.

Here too, the **FLAT TUBE** coil outperforms other solutions: the single component in aluminium only is far less susceptible to corrosion than a conventional bi-metal coil in copper and aluminium. As if that were not already enough, the direct expansion coil of the new **Y High Efficiency and R2 High Efficiency lines** outdoor units receive a special galvanic treatment with **sacrificial zinc anodes** to further prevent any possibility of corrosion, while a **waterproofing treatment** protects the copper pipes connecting the heat exchanger coil to the refrigeration circuit against electrolytic corrosion. A special version (denominated -BS) may be ordered for installations in highly saline conditions or coastal zones, which is specifically designed for these applications.

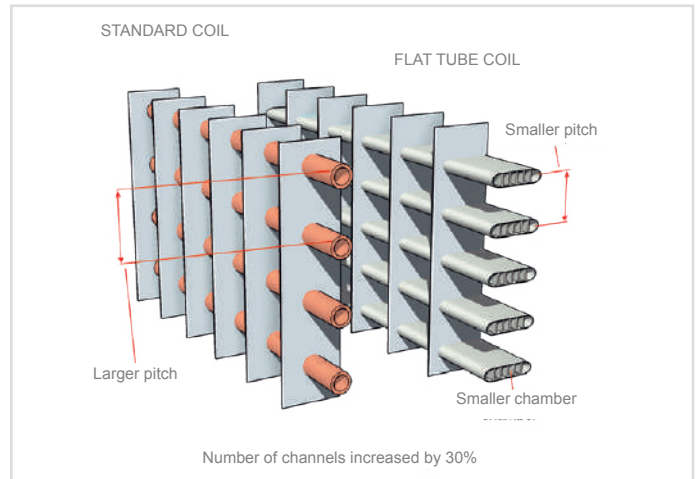

- ➔ +30% more piping
 - ➔ +17% more Contact with Piping
 - ➔ +26% more Contact with Refrigerant
 - ➔ Smaller Pitch and Pipe Chamber
 - ➔ Reduced Refrigerant Volume
- A world first for VRF systems**

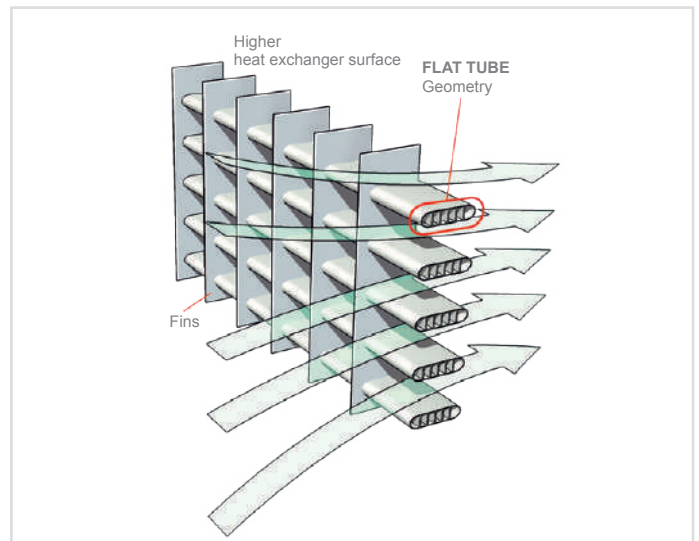



Inverter-driven compressor technology

All CITY MULTI compressors are of the inverter-driven type, capable of precisely matching a building's cooling and heating demands.

The compressor varies its speed to match the indoor cooling or heating demand and therefore only consumes the energy that is required. When an inverter driven system is operating at partial load, the energy efficiency of the system is significantly higher than that of a standard fixed speed, non-inverter system.

The fixed speed system can only operate at 100%, however, partial load conditions prevail for the majority of the time.

Therefore, fixed speed systems cannot match the annual efficiencies of inverter driven systems. Using proven single inverter driven compressor technology, the CITY MULTI range is favored by the industry for low starting currents (just 8 amps for a 20HP outdoor unit) and smooth transition across the range of compressor frequencies.

HEATING / COOLING CAPACITY

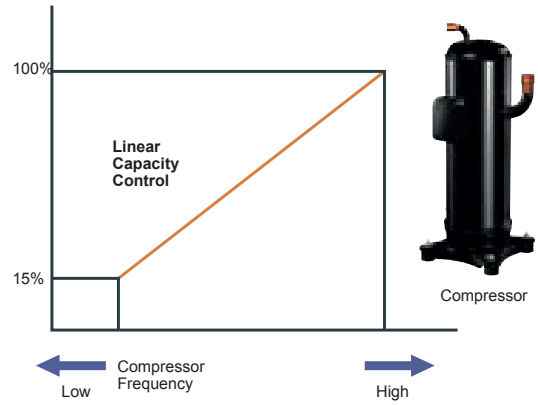

STABLE AND SMOOTH OPERATION

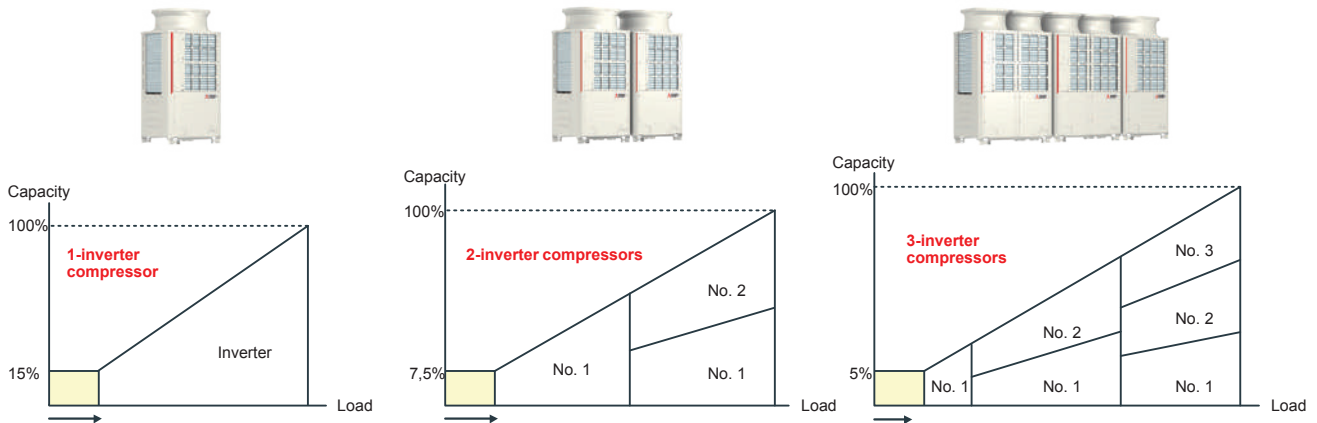

Heat recovery system

Comparison between different systems with different pipe connection points

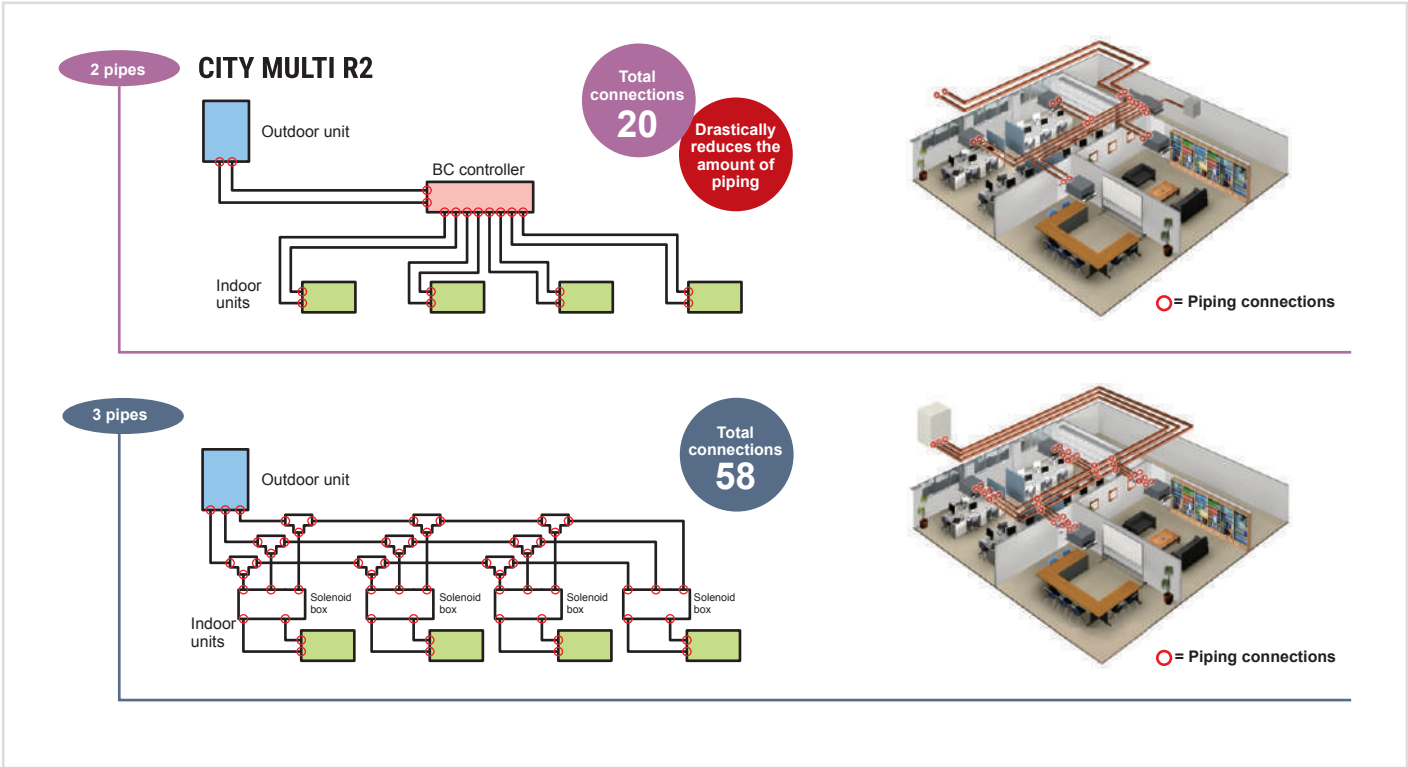

How does the R2 / WR2 heat recovery system work with two pipes?

The secret of the VRF CITY MULTI heat recovery system lies in the BC controller. The BC controller contains a liquid/gas separator which allows the outdoor unit to produce a two-phase mixture of hot gas for heating and liquid for cooling delivered through the same pipe. Three pipe systems use one pipe for

each of these two phases. The mixture is separated when it reaches the BC controller, and the correct phase (gas or liquid) is sent to each indoor unit in relation to individual demand for heating or cooling.

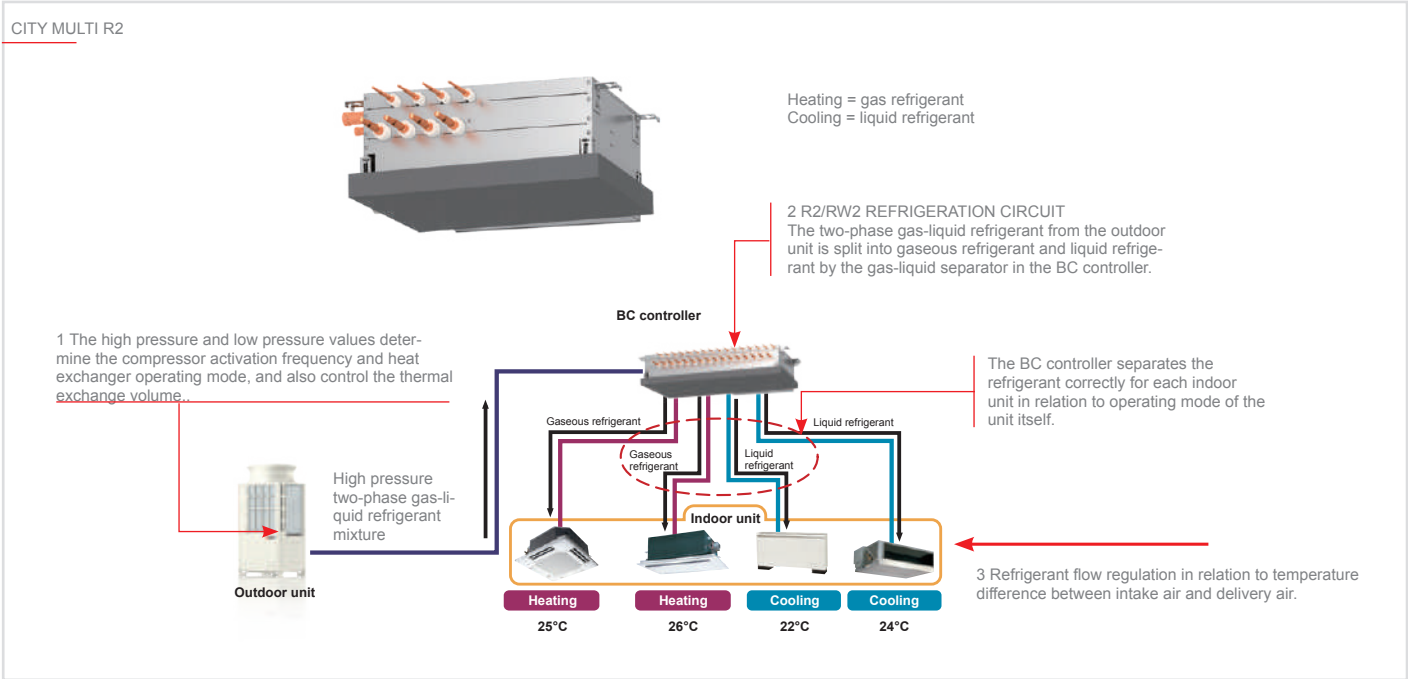

Heat recovery system

With the heat recovery system, the more often the simultaneous cooling and heating function is used, the greater the energy savings.

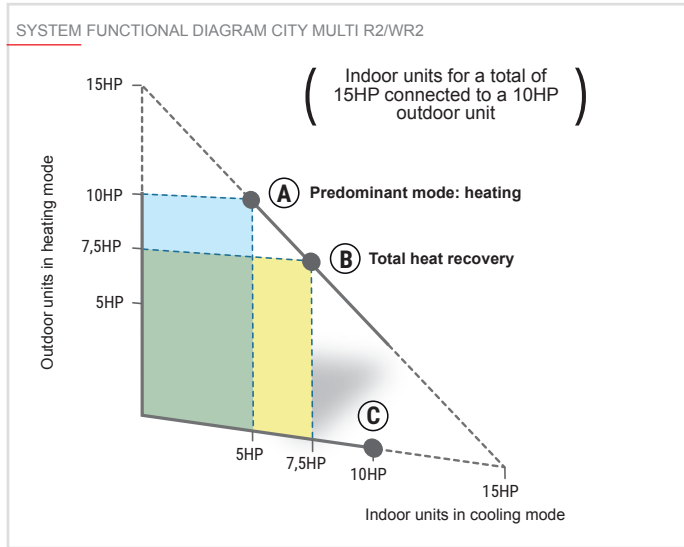

Why use heat recovery?

Flexibility and efficacy are decisive factors when choosing a system with heat recovery capability. For instance, while a heat pump system is suitable for an office with a large open space plan, in an office space subdivided into more units, a system is needed that can simultaneously heat and cool different zones in accordance with the preferences of each individual user. The efficacy of these systems stems from their ability to use by-products of cooling and heating to transfer energy where it is needed, therefore functioning as a balanced heat exchanger offering savings of up to 20% in operating costs compared with a conventional heat pump system. Moreover, the number of connection points needed for an R2 / WR2 system is significantly lower than the number required by a three pipe system. This reduces installation costs, further adding to the savings offered by using the VRF CITY MULTI system.

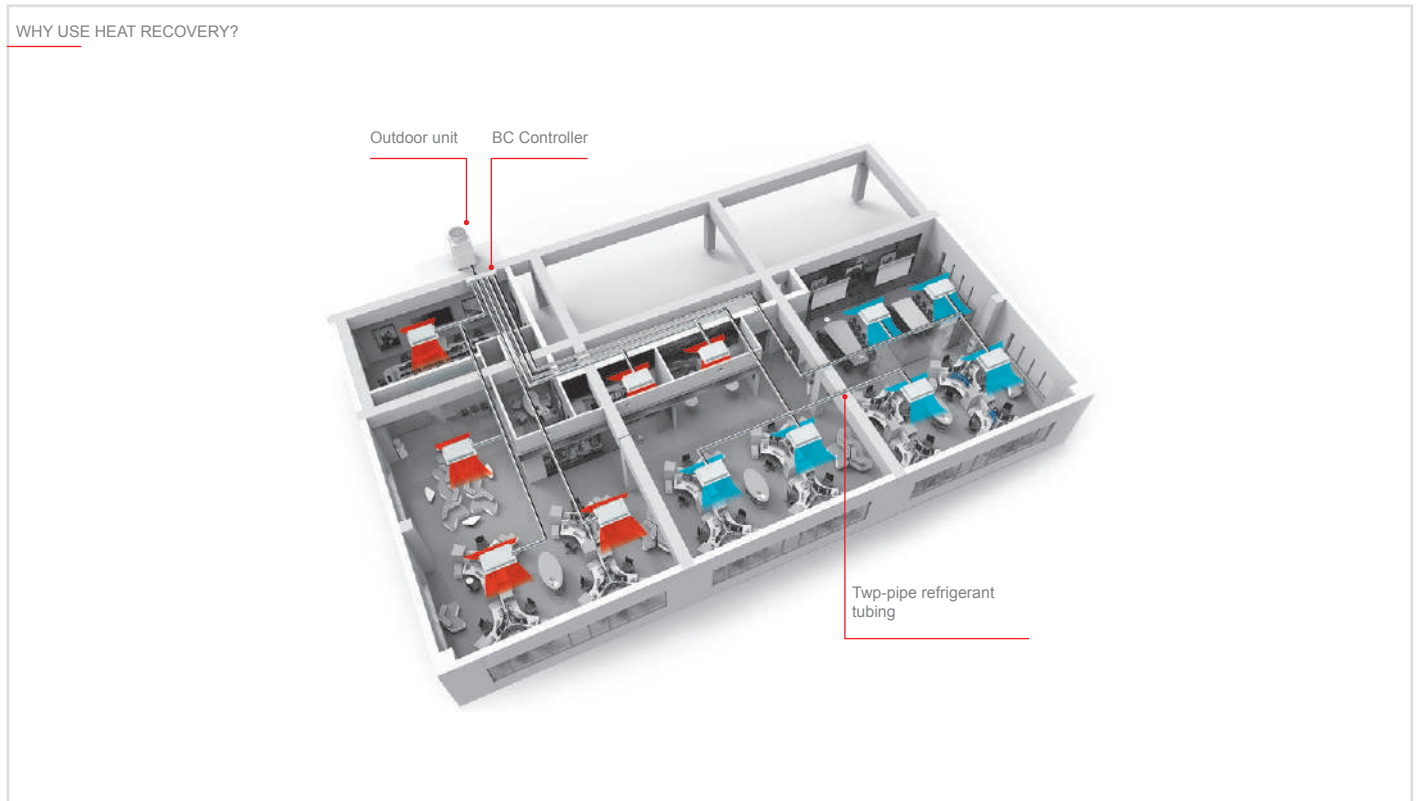

The LEV Kit system



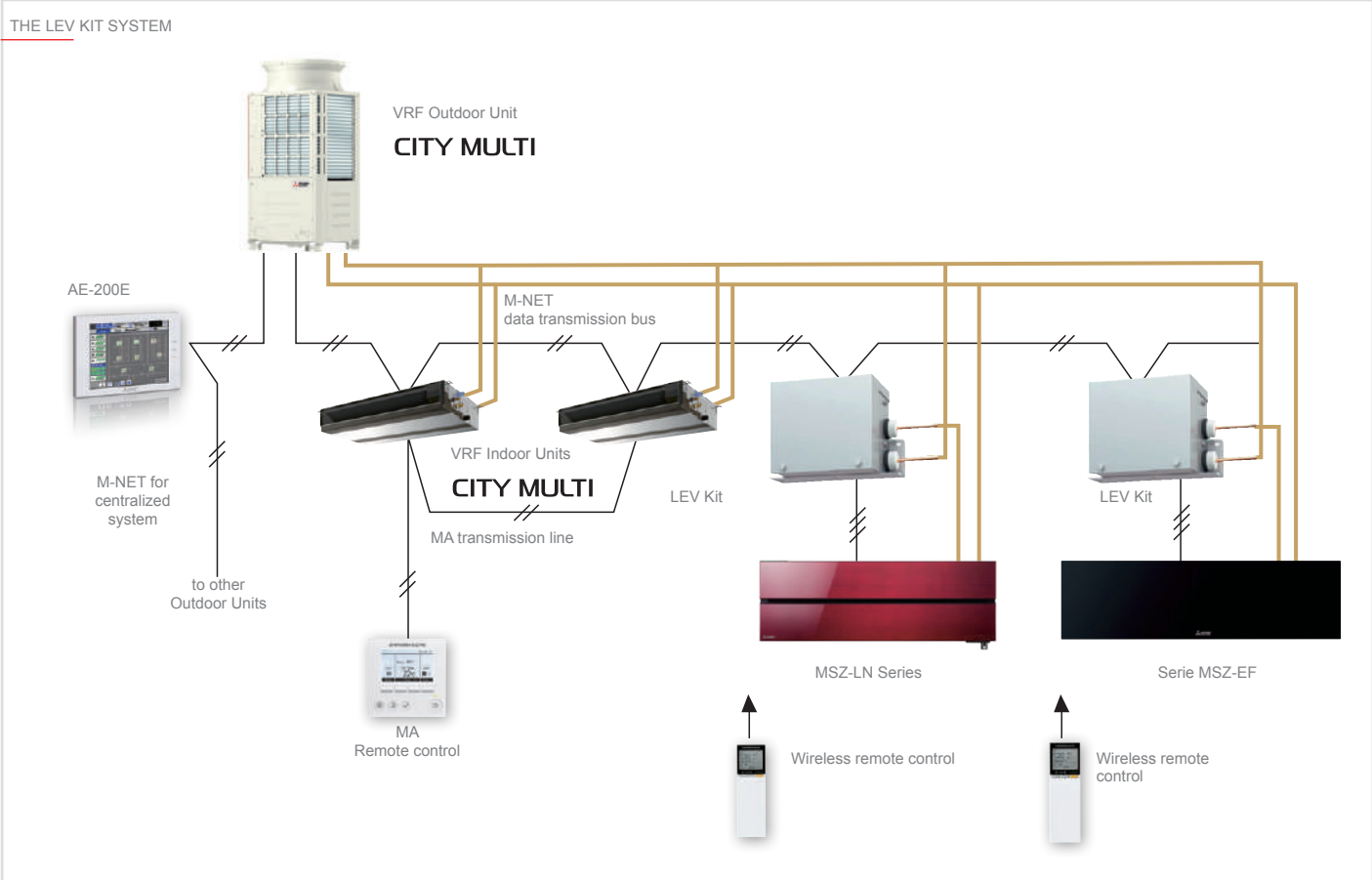

The LEV Kit makes it possible to use the indoor units of Residential Line – which represent the state of the art in Mitsubishi Electric air conditioning system design – together with VRF CITY MULTI systems. Mixed installations can therefore be created with complete freedom.



The Mitsubishi Electric external units compatible with the LEV Kit are:

- Small Y Line
- Small Y Compact Line
- Small Y High Capacity Line
- Y Ecostandard Line
- Y High Efficiency Line
- Y Next Stage Line
- Y Next Stage High Efficiency Line
- R2 Next Stage Line
- R2 Next Stage High Efficiency Line
- WY Line
- WR2 Line

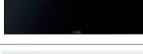
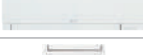

Types and Sizes available Residential indoor units	15	18	20	22	25	35	42	50
MSZ-LN_VG(2) 		•			•	•		•
MSZ-AP_VG(K) 	•		•		•	•	•	•
MSZ-EF_VE/VG 		•		•	•	•	•	•
MSZ-SF_VAVE3 	•		•	•	•	•	•	•
MFZ-KJ_VE 					•	•		•
MFZ-KT_VG 					•	•		•

ATTENTION !! FOR DETAILS ON COMPATIBILITY BETWEEN EACH MODEL OF INDOOR UNITS AND OUTDOOR UNITS PLEASE CONTACT YOUR LOCAL DISTRIBUTOR

Functions

M-NET Power

With the M-Net transmission line and the use of separate power and control circuits for indoor units, the following states can be identified automatically:

- indoor unit malfunction
- power loss to indoor unit.

In the event of one of these conditions, the outdoor unit isolates the malfunctioning indoor unit or indoor unit receiving no power to ensure the continued electrical and refrigeration functionality of the system with no action required from a technician and/or a system administrator. This allows total flexibility in planning and laying out 220V AC power circuits, without the need for shared main lines and without requiring any additional devices to attain compliance with legislation for electrical systems. This circuit configuration is essential for situations where the system itself is shared by multiple owners or tenants, and where each must be able to electrically isolate their respective indoor terminal sections when required.

Continuous operation

In the event of power loss or partial malfunction of one or more indoor units, the system continues to function uninterruptedly and without requiring any action from a technician and/or system administrator.

Continuous heating operation

Normally, it is necessary to stop the heating operation during defrosting. However, the continuous heating operation method makes it possible to perform defrosting while the heating operation continues.

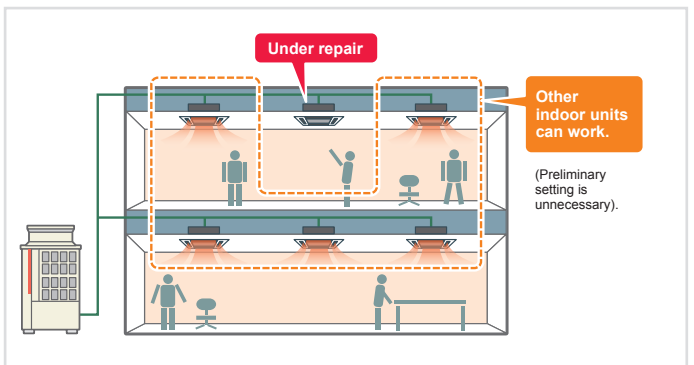
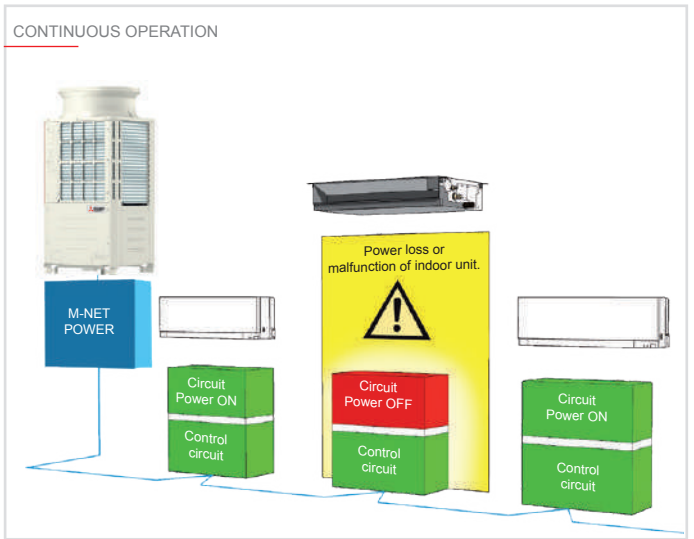

Reduction in the stoppage time of the heating operation prevents drops in room temperature.

Use a dip switch on the outdoor unit to switch between the continuous heating operation method and the conventional defrosting method.

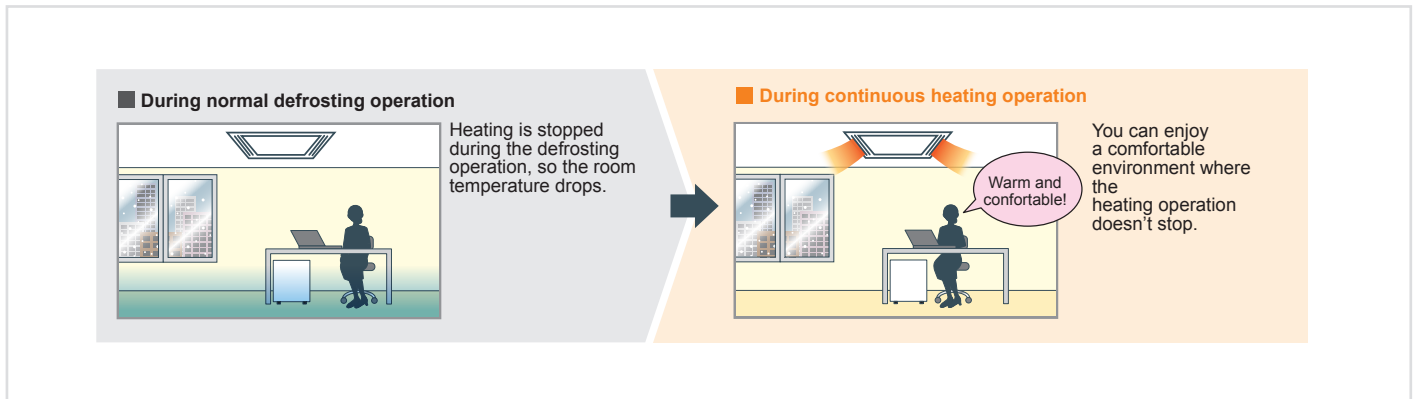

Continuous heating operation image (single unit)

The heat exchanger of the outdoor unit is split into parts. Even when defrosting is necessary, the heating operation is continued with a part of the heat exchangers.

Continuous heating operation image (combination)

With the combination model, units perform defrosting alternately. While one unit is performing defrosting, the other continues heating.

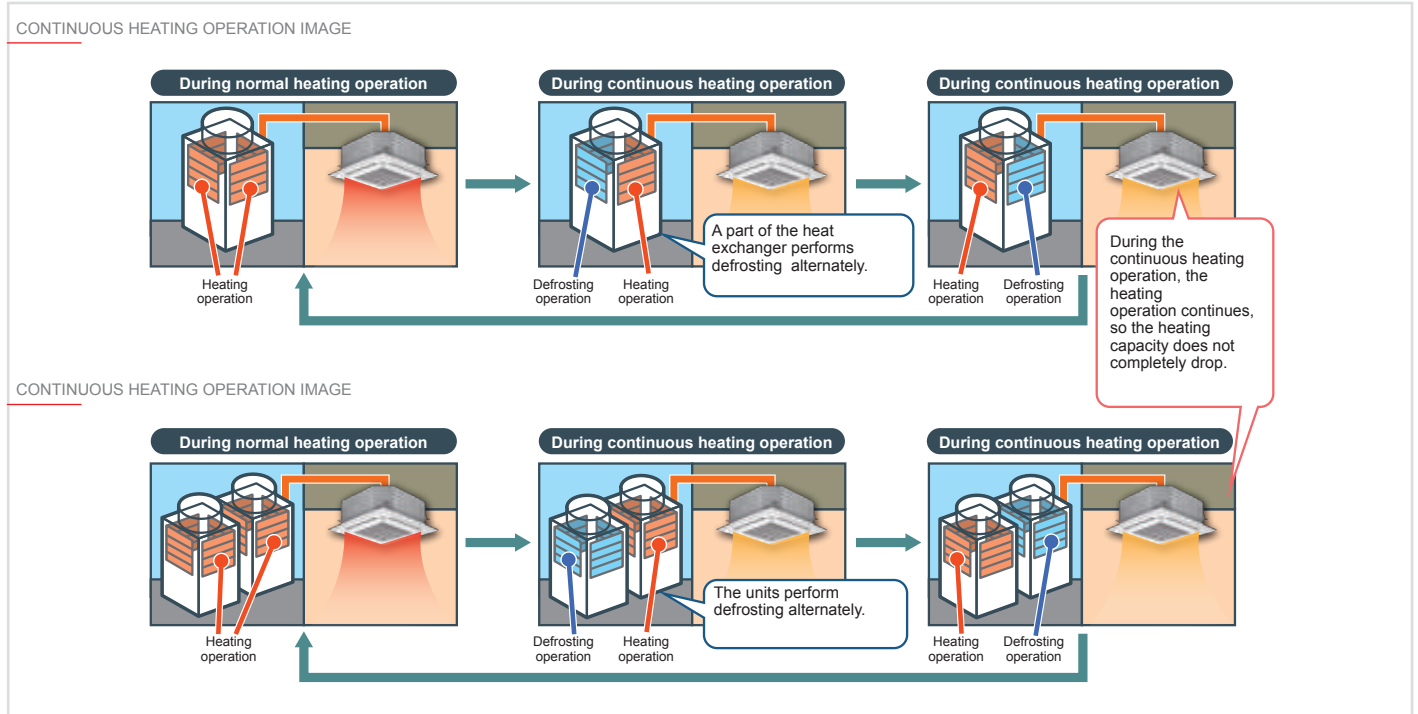

Preheat defrost operation

The new outdoor unit is equipped with a preheat defrost operation that raises the discharge temperature of the air before beginning defrost operation. This contributes to raising the room temperature before the start of defrost operation and prevents room occupants experiencing a chilling sensation.

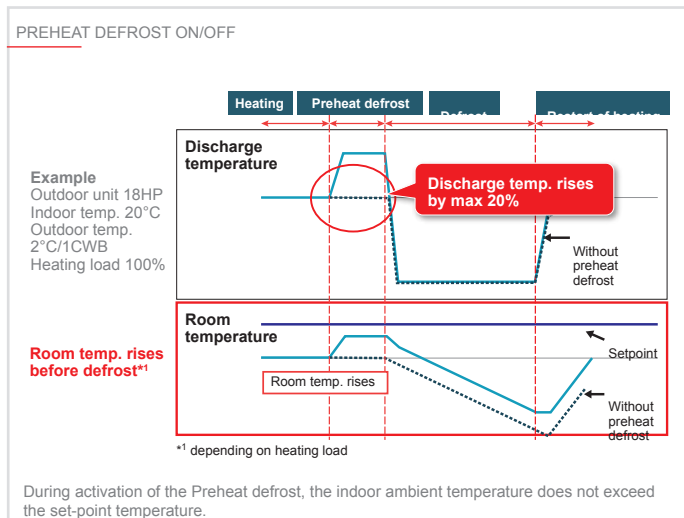

Flexible Noise Setting

The "Low Noise" mode, which conventionally only had one pattern, has been increased to four patterns so that a mode can be selected from a total of five patterns, including the rated pattern. The low-noise mode has four patterns 85%, 70%, 60% and 50% in respect to the fan speed. This can be set with the outdoor unit's DIP switch. The pattern can be selected according to the customer's requests when low-noise operation is required.

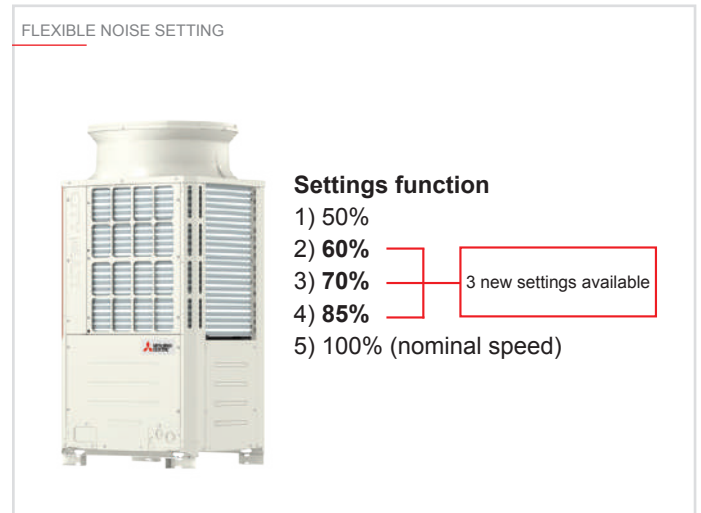

200% extended connectivity system

The innovative Ecodan® HWS & ATW unified VRF system by Mitsubishi Electric for cooling, heating and domestic hot water production brings VRF technology to the heating market.

To ensure correct power usage in applications such as centralized residential systems and hotels, where permitted by the coincidence factor, Mitsubishi Electric offers a system allowing up to 200% extended connectivity.

The 200% extended connectivity system offers the advantage of simplified, intuitive and, most importantly, automated operation comparable to a conventional centralized heating system (e.g. gas boiler), meaning that the professional installer is no longer required to include complicated, redundant management and adjustment systems.

System architecture

For example, in a hypothetical installation with a P200 outdoor unit, this system permits the connection of units with a total power index equal to 200% that of the outdoor unit (P400), subdivided according to the following rules:

- Maximum power index for hydronic modules = P200 (100% of outdoor unit power index)



Extension of operating limit in Cooling to 52°C

In certain types of installation and in areas with high building density the passage of air can be obstructed. In very high outdoor temperature conditions and if the air expelled by the unit's fan is not correctly removed, it can stagnate and increase the air temperature around the machine. Thanks to an extended operating range of up to 52°C, the system can operate uninterruptedly even in these conditions.

- Maximum power index for indoor modules = P200 (100% of outdoor unit power index)

A VRF Ecodan® installation with this configuration will ensure simultaneous operation up to a power index of 130%, in the case of a Y heat pump system, and up to 150% in the case of an R2 heat recovery simultaneous heating and cooling system.

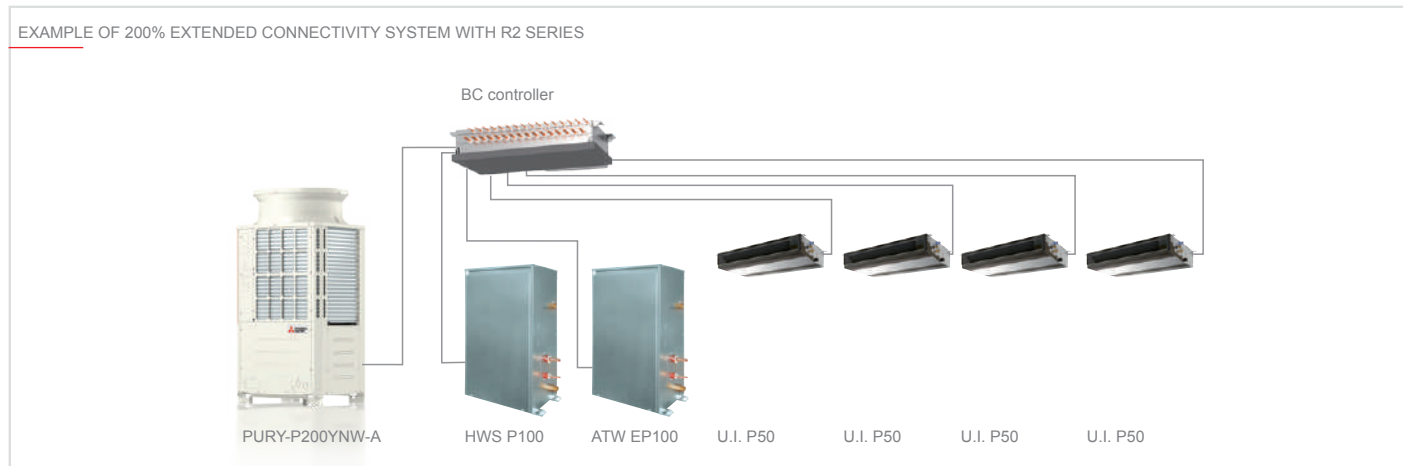

The right power for the right application

The 200% extended connectivity system conceived by Mitsubishi Electric is applicable only for mixed configurations with simultaneous production functions: Heating with standard VRF indoor units, primary heating function with ATW hydronic modules and domestic hot water production with HWS modules (in this case, only with R2 heat recovery simultaneous cooling and heating systems). This system requires that a precise operating limit is defined that will ensure that the outdoor unit power drawn is appropriate for the ambient loads effectively to be satisfied in all operating conditions and at all times. As a consequence, it is always important to evaluate maximum simultaneous power demand in the different operating modes possible.

Operation with heat pump systems Y (PUHY))

Application	ATW Hydronic Module Indoor unit	Indoor unit
	Primary Heating	Air Cooling and Heating
Winter	On	Off
Autumn/Spring	Off	On
Summer	Off	On

Operation with simultaneous cooling and heating heat recovery systems (R2 (PURY))

Application	ATW Hydronic Module	ATW Hydronic Module	Indoor unit
	DWH Production	Primary Heating	Air Cooling and Heating
Winter	On (365days/year)	On	Off
Autumn/Spring	On (365days/year)	Off	On
Summer	On (365days/year)	Off	On



Extended settable temperature range in cooling mode, with minimum temperature of 14°C*

Where the ability to cool to temperatures lower than the standard lowest comfort value of 19°C (typically for sports centres, laboratories etc.) is necessary, the settable temperature range in cooling mode may be extended to offer a lowest temperature of 14°C.

The indoor unit fan is run at a higher speed in this configuration (except with the SMALL Y model outdoor unit of the PUMY series).

*Contact your local distributor for compatible indoor units with this function.



Rotation function

Y Series (Ecostandard Line, Y Line and Y High Efficiency Line) and R2 Series (Y Line and Y High Efficiency Line) combined modules use an automatic “Rotation Function” routine which optimises the usage of indoor and outdoor units to extend the lifespan of all system components.



Emergency backup function

Y Series (Ecostandard Line, Y Line and Y High Efficiency Line) and R2 Series (R2 Line and R2 High Efficiency Line) combined modules offer unparalleled reliability with the new emergency backup function, which is easily activated from the remote control of any indoor unit in the event of a system malfunction.

The backup function allows the system to continue operating in heating and cooling mode for an average period of 4 hours.



Energy efficiency control

Evaporating temperature control (during cooling)

In a traditional system, the evaporation temperature is kept constant regardless of the system load conditions. In low load conditions (when thermal loads to be dealt with are limited) increasing the evaporation temperature of the system decreases the compressor's workload and consequently limits the electrical absorption of the outdoor unit without affecting the environmental comfort level.

EVAPORATING TEMPERATURE CONTROL (DURING COOLING) NORMAL MODE

The evaporating temperature is kept constant regardless of the load. Even at low loads, the normal evaporating temperature does not change, which leads to energy losses during partial load operation.

SMART EVAPORATING TEMPERATURE CONTROL MODE

The evaporating temperature is increased and the compressor input is decreased according to the load, resulting in increased operating efficiency. There are two patterns to control the evaporating temperature as follows.

- 1) The evaporating temperature is controlled to be constant, regardless of the ΔT . The evaporating temperature is set to a value that is higher than the normal evaporating temperature.
- 2) The evaporating temperature is controlled by shifting it according to the ΔT . The user can select from 4 control patterns.

* The availability of 1 and 2 varies depending on the model. Refer to the function table.
* Changing the evaporating temperature reduces latent heat capacity. Select an appropriate pattern according to the installation conditions.

SUITABLE SITUATIONS

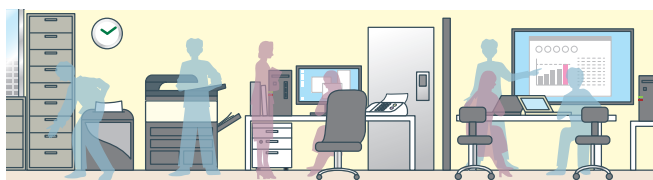

- Spaces with constant high temperatures from heat sources such as OA equipment
- When the load is low during periods when air conditioners are used for cooling (such as during the morning).

The new outdoor units are equipped with an evaporation temperature selection function, which automatically takes the system load conditions into account.

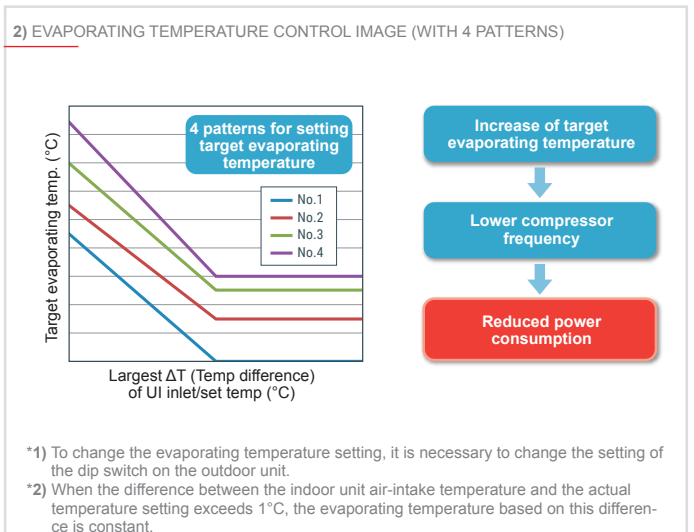
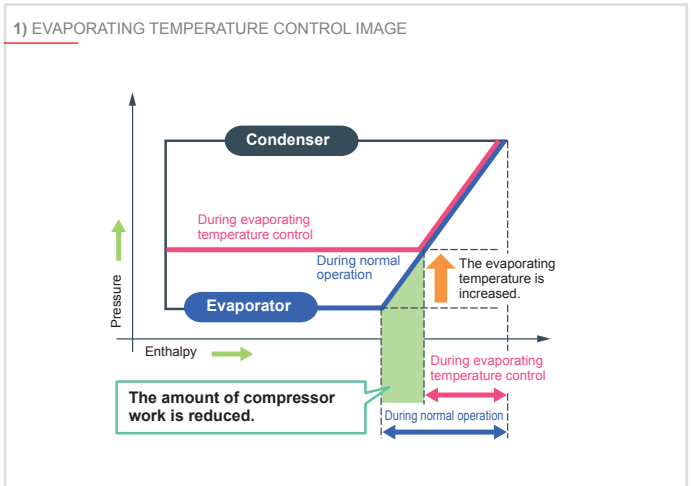

*1) To change the evaporating temperature setting, it is necessary to change the setting of the dip switch on the outdoor unit.
*2) When the difference between the indoor unit air-intake temperature and the actual temperature setting exceeds 1°C, the evaporating temperature based on this difference is constant.

High sensible heat

High sensible heat operation

The evaporating temperature is controlled according to room temperature and humidity, and refrigerant pressure.

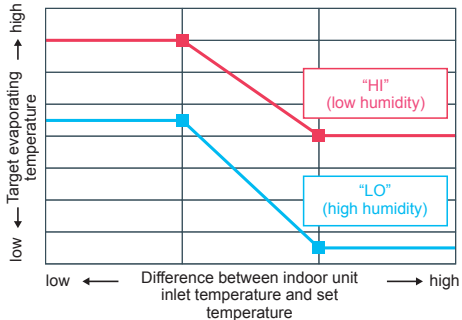

With high sensible heat operation mode activated, air conditioners consume less energy, thereby realizing cost savings. If a locally-procured humidity sensor is installed, the evaporating temperature of the outdoor unit can be controlled optimally as shown below according to the difference between the indoor unit inlet temperature and set temperature. A wide range of temperature settings are available, from a low evaporating temperature close to the temperature for normal operation to a high evaporating temperature to realize energy savings.

LOCALLY-PROCURED HUMIDITY SENSOR INSTALLATION IMAGE

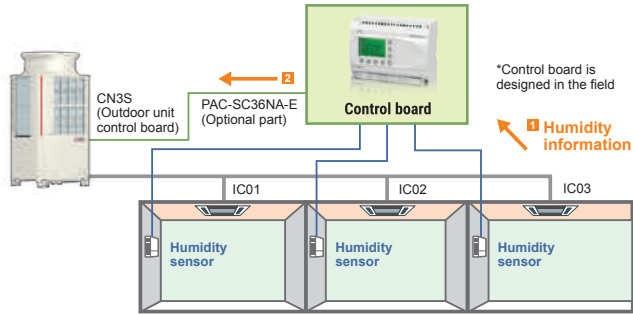

- 1 Humidity information is sent to the control board.
- 2 The control board judges the humidity information, and sends a HIGH/LOW signal to the outdoor unit through CN3S. The outdoor unit shifts the evaporating temperature depending on the information from the control board.

**Humidity sensor → field supply

TEMPERATURE AND HUMIDITY CONDITIONS

	Room state	Condition of outdoor unit	Zone	Evaporating temperature control
<p>Comfortable temperature and humidity</p> <p>High sensible heat operation</p>	<p>Comfortable</p>	<p>Comfortable and energy-saving operation even at low compressor rotating speed</p>	<p>Humidity</p> <p>Temperature</p>	<p>Temperature of refrigerant in indoor unit kept high</p>
<p>High humidity</p>	<p>A little humid</p>	<p>Compressor rotating at medium speed to reduce humidity</p>	<p>Humidity</p> <p>Temperature</p>	<p>Temperature of refrigerant in indoor unit slightly reduced</p>
<p>High temperature and humidity</p>	<p>Uncomfortable</p>	<p>Compressor rotating at high speed to reduce temperature and humidity</p>	<p>Humidity</p> <p>Temperature</p>	<p>Temperature of refrigerant in indoor unit greatly reduced</p>



Dual Set Point

Normally, the desired room temperature is set to the same value for cooling and heating. However, the dual set point function makes it possible to set different temperatures for cooling and heating. When operation switches from cooling to heating or vice versa, the preset temperature changes accordingly.

Setting dual set points for the Auto mode on R2 and WR2 helps improve energy efficiency, compared to setting a single set point.

When the operation mode is set to the Auto (dual set point) mode, two preset temperatures (one each for cooling and heating) can be set. Depending on the room temperature, the indoor unit will automatically operate in either the Cool or Heat mode and keep the room temperature within the preset range. The outdoor unit does not operate in the dead band defined by two temperature points where the thermostat is off. This cuts down on unnecessary operation of the air conditioning system.

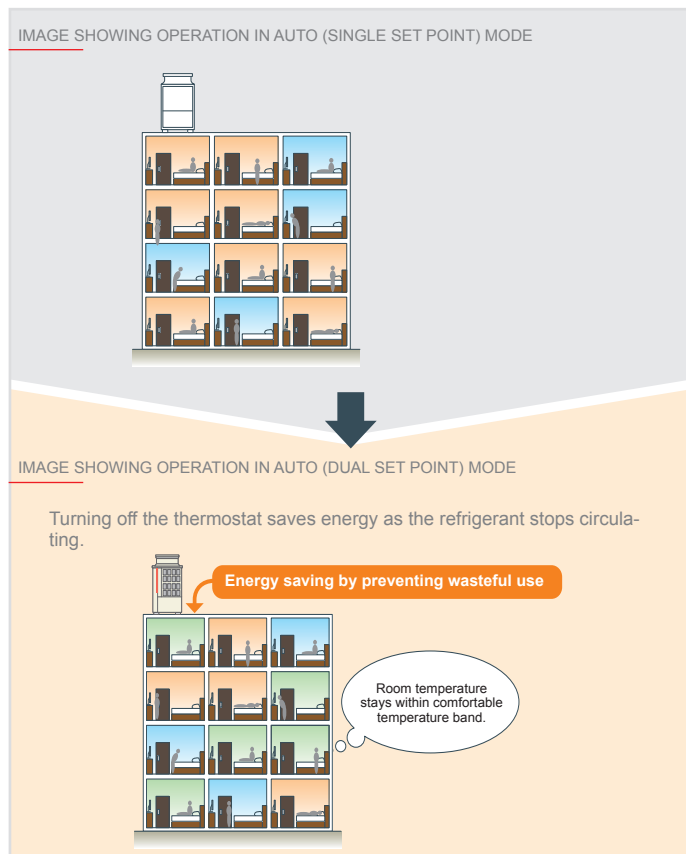
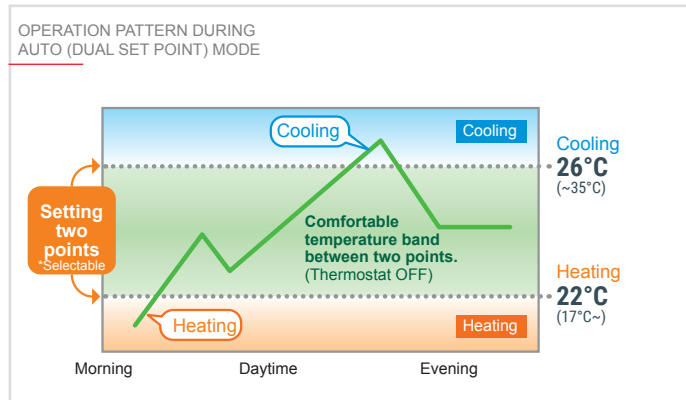

Heating operation Cooling operation Thermo OFF



Smooth auto-shift startup mode

Smooth auto-shift startup mode, a new operation mode on the outdoor unit, can now be selected in addition to the conventional COP Priority and Capacity Priority modes. In order to heat the room faster, Capacity Priority mode runs for 30 minutes when heating operation starts. The unit then switches to COP Priority mode to increase energy-saving efficiency. This enables both improved comfort and energy savings.

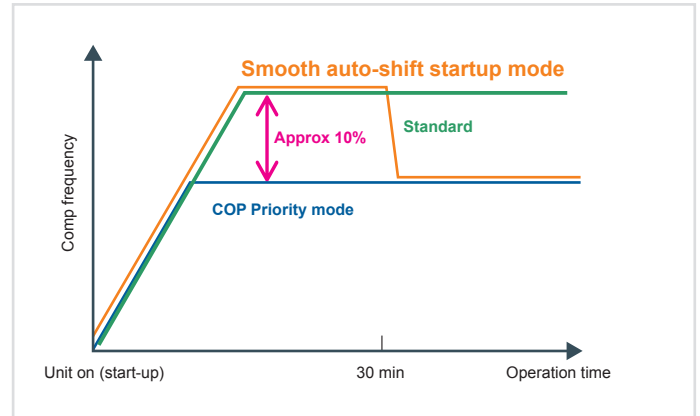

Compressor: new induction heating technology

The Y Line and R2 Line outdoor units employ a pre-heating system for the scroll compressor based on induction technology. This solution is used to warm the compressor housing to minimise energy absorption in stand-by state. Yet another solution contributing to reducing energy consumption.



Installation and maintenance

R410A R407C R22

Multi-refrigerant

The indoor units of VRF CITY MULTI systems are the first and only products on the market with multi-refrigerant capability. These units can operate with R22, R407C and R410A systems with no loss in performance, irrespective of the different pipe sizes. This allows unparalleled freedom for installation, as well as offering total reverse compatibility in the event of replacing indoor units with an R22 or R407C VRF CITY MULTI system.

80Pa ↑ Selectable external static pressure of the outdoor unit

The static pressure specification of the outdoor unit can be selected (0, 30, 60, or 80 Pa). This facilitates installation of the unit on each floor of a high-rise building or on balconies.
* The static pressure that can be set varies depending on the model.

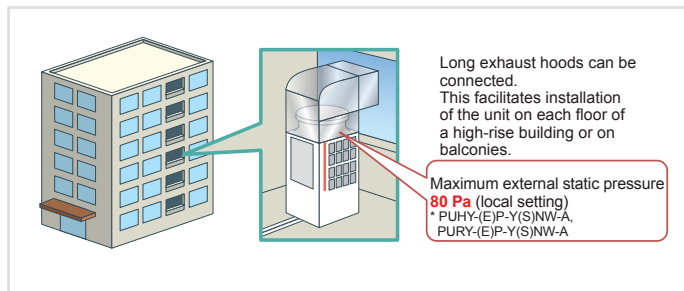

Intelligent Terminal Boards

Intelligent indoor unit terminal boards are a unique feature of Mitsubishi Electric VRF systems. These intelligent terminal boards make it possible to use the air conditioning system and the M-NET communication network, via the indoor units, as a vehicle for collecting, transferring and monitoring field signals from generic appliances such as lighting, power, access management, intelligent alarm systems etc. Using the intelligent terminal boards of the indoor units together with the existing infrastructure drastically reduces the number of cables needed to collect these field signals and the amount of labour required to route the cables to the centralized units. Typically, each indoor unit supports the following signals and functions:

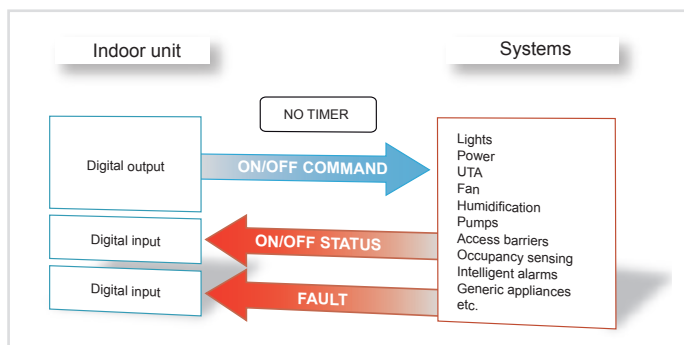

90m ↑ Usable in an application with a large vertical separation of up to 90 meters

A height difference of up to 90 m from the outdoor unit to the indoor unit can be supported with no extra-cost options. This increases design flexibility and facilitates installation of these units even in high-rise buildings.

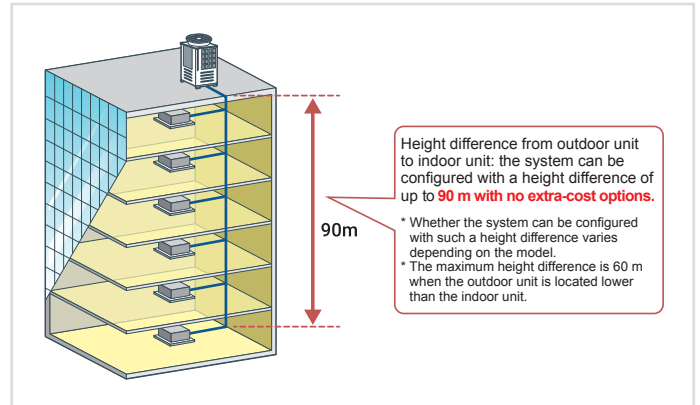

Self-diagnosis of VRF CITY MULTI system

For even simpler maintenance, CITY MULTI systems have a self-diagnostic function which is capable of communicating malfunctions on different levels using fault codes. With the special Maintenance Tool software developed by Mitsubishi Electric, the user can connect to any point in the transmission line to acquire all technical operating information interactively.

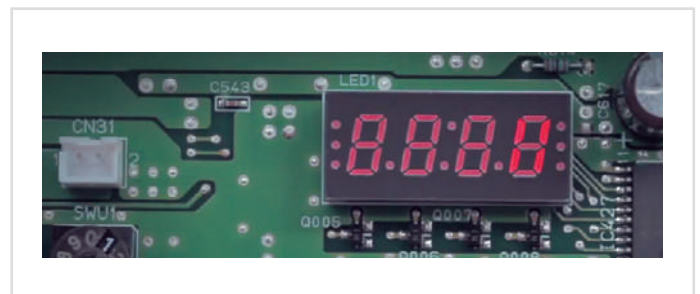



USB ↓ Downloading operating data via USB

Operation data was retrieved from conventional models using the maintenance tool. On the new model, the data can be retrieved quickly via USB*1. It is unnecessary to carry the personal computer in which the maintenance tool has been installed, reducing field operation time and improving convenience. Software can be rewritten via USB, while data for up to 4 days and the 5 minutes after an error has occurred can be stored in the the USB memory device*2.

*1 In the case of OC-IC maximum configuration
*2 USB memory devices conforming to USB2.0 can be used.

Remote monitoring and control systems

			
Group/Individual simplified management*	•	•	•
Available for Smartphone and Tablet	•	•	•
Dedicated App		•	•
User restrictions	•	•	•
Outside the building (Cloud)		•	•
Internet connection needed		•	•
WEB Server centralized control needed	•		•
Advanced energy monitoring			•
Monthly/Custom charts and reports			•
Multi-site management		•	•
Energy consumption apportioning			•

* For compatible product lines please refer to catalogues or contact headoffice



3D Tablet Controller

3D Tablet Controller is the new solution by Mitsubishi Electric allowing portable system management from Smartphone and Tablet **inside the building**. User configuration, with restrictions and privileges, makes it the ideal solution in those application serving different environments, such as offices or apartments. Thanks to its simple and intuitive interface the user is able to control and monitor **air conditioning** and **hot water production** units on **mobile device**, just as easily as he would on a traditional remote control. This is possible thanks to WEB Server 3D centralized control installed on site, connected to the building Wi-Fi router.

MELCloud



- Cloud remote **monitoring and control** system.
- Born for residential applications, it's now being expanded to VRF CITY MULTI.
- **Complete and intuitive** solution with all main control and monitoring functions.
- Does not require WEB Server 3D centralized control (AE-200, EW-50).

RMI



- Cloud remote monitoring and control system **for professional use**.
- Allows all main remote control and monitoring functions.
- **Advanced energy monitoring** features are available, such as hourly consumption view, custom charts and data collection and display.
- Geo-localized **multi-site** management.
- **Multi-user** management for centralized systems.
- Energy **consumption apportioning**.







Mitsubishi Electric for sustainability

Thanks to our network of qualified professionals, we can contribute to obtain BREEAM and LEED certifications during the design stage.



Our sustainable solutions will help you improve your BREEAM and LEED rating. We at Mitsubishi Electric have carried out BREEAM- and LEED-certified projects across Europe.

Environmental sustainability

CITY MULTI

BREEAM® Launched in the 1990s, BREEAM is one of the best-known tools to assess and certify the sustainability performance of a building.

BREEAM is based on a rating that is clear and transparent for both the client and the professionals operating in the construction industry. All this has a positive impact on the activities carried out from the design stage to when the building is used.

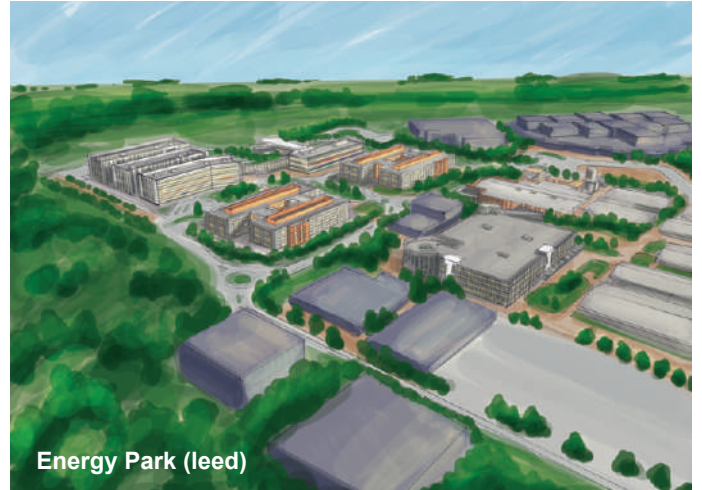

The LEED certification plays a primary role in energy and environmental design. It ensures the use of efficient and sustainable resources, as well as environmentally friendly management of the building.

The assessment criteria include sustainability of the site, energy, materials and resources used, quality of the air, internal environment, design and innovation.

There are four levels of certification: Basic, Silver, Gold, and Platinum.



All registered trademarks, brand names, and logos used or mentioned herein are the exclusive property of their respective owners and are used only for identification and description purposes.



Ecodesign - The ErP Directive

CITY MULTI

The European ecodesign directive on energy-related products (ErP) has become even more stringent to reduce greenhouse gas emissions resulting from the construction and real estate industries, overall energy consumption, and accelerate the transformation of this market with energy-efficient products.

An air conditioning system will change the performance with the changing of the seasons. That's why it's important to calculate its seasonal energy efficiency ratio (SEER) and the seasonal coefficient of performance (SCOP).

The ecodesign directive establishes the minimum efficiency requirements and a new method for measuring performance. The directive was implemented in the EU through the EN14825 standard, which establishes the seasonal performance factors of a climate control system.



Scan the QR code
to visit the website

Visit the website

erp.mitsubishielectric.eu/erp



BIM - Building information modelling

CITY MULTI

BIM is a collaborative way of working that allows the design team to share a virtual information model of a building and analyse its life cycle from design to demolition, highlighting any criticality of the technologies used.

This approach helps increase productivity and sustainability while improving risk management and reducing waste and costs.

BIM is not a tool. It's a method for working and sharing information that requires teamwork and collaboration, from when a building is first designed and commissioned to when it's used.

BIM can include any information about the building or parts of it. Usually, the information collected is about the geographic location, geometry, properties of the materials and technical elements, execution phases, and maintenance operations.

We at Mitsubishi Electric share our BIM files through the MEP content platform.

Click this link to access our BIM library
www.mepcontent.com/en/bim-files/



**Are you a designer of HVAC systems?
 Then MMESD (Mitsubishi Electric System Designer) for Revit and AutoCAD is the add-on you need.**

Download it now.
 You can use CAD files and Mitsubishi Electric Revit families to design in BIM successfully. If you have any doubts, our video tutorials can help solve them.

Click the link
bit.ly/2OeczaB
 to download the app and watch the demo

Click the link
bit.ly/2W5E0rh
 to watch the video tutorials

MEPcontent

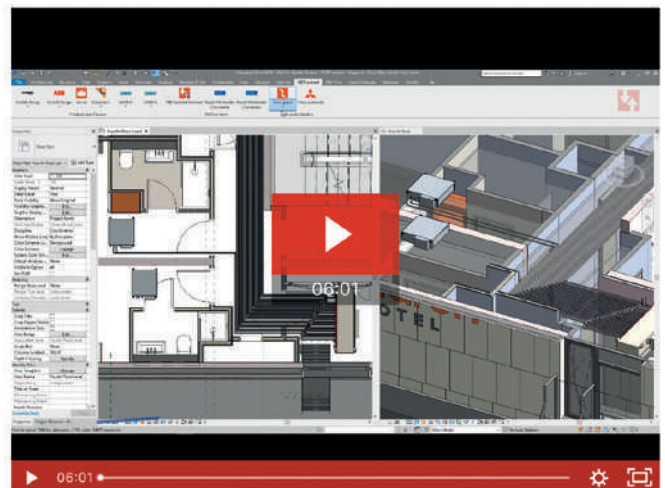





VRF Systems

Outdoor units

Air condensed

SMALL Y COMPACT LINE

PUMY-SP Y(V)KM -R1(-BS)	42
-------------------------	----

SMALL Y LINE

PUMY-P Y(V)KM(-BS)	46
--------------------	----

SMALL Y (HIGH CAPACITY) LINE

PUMY P200 YKM2 (-BS) / PUMY P250/300 YBM (BS)	50
---	----

Y ECOSTANDARD LINE

PUHY-P Y(S)KA(-BS)	54
--------------------	----

Y HIGH EFFICIENCY LINE

PUHY-EP YLM-A1 / YSLM-A1(-BS)	58
-------------------------------	----

Y NEXT STAGE LINE

PUHY-(E)P Y(S)NW-A1(-BS)	62
--------------------------	----

R2 NEXT STAGE LINE

PURY-(E)P Y(S)NW-A1(-BS)	72
--------------------------	----



Water condensed

WY WR2 LINE

PQH(R)Y-P Y(S)LM-A1 80

BC controllers for R2 lines





CMB-M V-J1/V-JA1/V-KB1, CMB-P V-KA1 88

WCB water-refrigerant connection box







CMB-PW202V-J 94

Refrigerant piping lenght

96

		Line					
		Model	PUMY-SP-Y(V)KM	PUMY-P-Y(V)KM4(5)	PUMY P-YKM/YBM	PUHY-P-Y(S)KA	
Technology	Inverter-driven compressor technology	•	•	•	•		
	IH warmer				•		
	Flat tube Heat exchanger						
Function	Operation mode	COP priority mode				•	
		Low noise mode	•	•	•	50, 100%	
		Auto-shift mode	Super silent mode				
		Dual set point	•	•	•	•	
	Energy efficiency control	Evaporating temperature control (Fixed temperature control irrespective of the ΔT)				+4 °C, +9°C, +14°C	
		Evaporating temperature control (Automatic control shifting according to the ΔT)				4 patterns	
		High sensible heat operation (during cooling)					
		Demand control	4 steps	4 steps	4 steps	12 steps	
	Defrosting	Continuous heating operation					
		Pre-heat defrost					
	External static pressure	Selectable external static pressure of outdoor unit	30 Pa	0 Pa	30 Pa YBM only	0, 30, 60 Pa	
	High ambient temperature	Operation at high outside temperatures	52°C	52°C	52°C	52°C	
	Piping length flexibility	Usable in an application with a large vertical separation of up to 90 meters					
	Maintenance	Rotation control				•	
		Emergency operation mode				•	
		Pump down function				•	
		M-Net Power	•	•	•	•	
USB Data download							

* Power supplied to the heater only for 22HP and 24HP (P550 and P600) single modules

							
	PUHY-EP-Y(S)LM-A1(BS)	PUHY-P-Y(S)NW-A1	PUHY-EP-Y(S)NW-A1	PQHY-P-Y(S)LM-A1	PURY-P-Y(S)NW-A1	PURY-EP-Y(S)NW-A1	PQRY-P-Y(S)LM-A1
	•	•	•	•	•	•	•
	•	•	•	• *	•	•	• *
	•	•	•				
	•	•	•				
	50, 100%	50, 60, 70, 85, 100%	50, 60, 70, 85, 100%	50, 100%	50, 60, 70, 85, 100%	50, 60, 70, 85, 100%	50, 100%
		•	•		•	•	
	•	•	•	•	•	•	•
	+6°C, +9°C, +14°C	+6°C, +9°C, +14°C	+6°C, +9°, +14°C	+6°C, +9°, +14°C	+6°C, +9°, +14°C	+6°C, +9°, +14°C	+6°C, +9°, +14°C
	4 patterns	4 patterns	4 patterns	4 patterns	4 patterns	4 patterns	4 patterns
	•	•	•	•	•	•	•
	12 steps	12 steps	12 steps	8 steps	8 steps	8 steps	8 steps
	•	•	•		•	•	
		•	•		•	•	
	0, 30, 60 Pa	0, 30, 60, 80 Pa	0, 30, 60, 80 Pa		0, 30, 60, 80 Pa	0, 30, 60, 80 Pa	
	52°C	52°C	52°C	-	52°C	52°C	-
	•	•	•		•	•	
	•	•	•	•	•	•	•
	•	•	•	•	•	•	•
	•	Automatic	Automatic	•	Automatic	Automatic	•
	•	•	•	•	•	•	•
		•	•		•	•	

SMALL Y COMPACT LINE

OUTDOOR UNITS - PUMY-SP Y(V)KM -R1(-BS)



COMPACT SIZE AND
LOW WEIGHT

MAXIMUM FLEXIBILITY
OF CONNECTION
THROUGH BRANCH
BOX

TOP OF THE RANGE
EFFICIENCY



SUPER SILENT MODE

UP TO 30 PA STATIC
PRESSURE OUTDOOR
FAN UNIT

FLEXIBLE PIPE
CONNECTION

Compact dimensions

The SMALL Y COMPACT (PUMY-SP) delivers the power and performance of a VRF system in residential applications with a significantly smaller footprint than ever before, thanks to its new single-fan design.

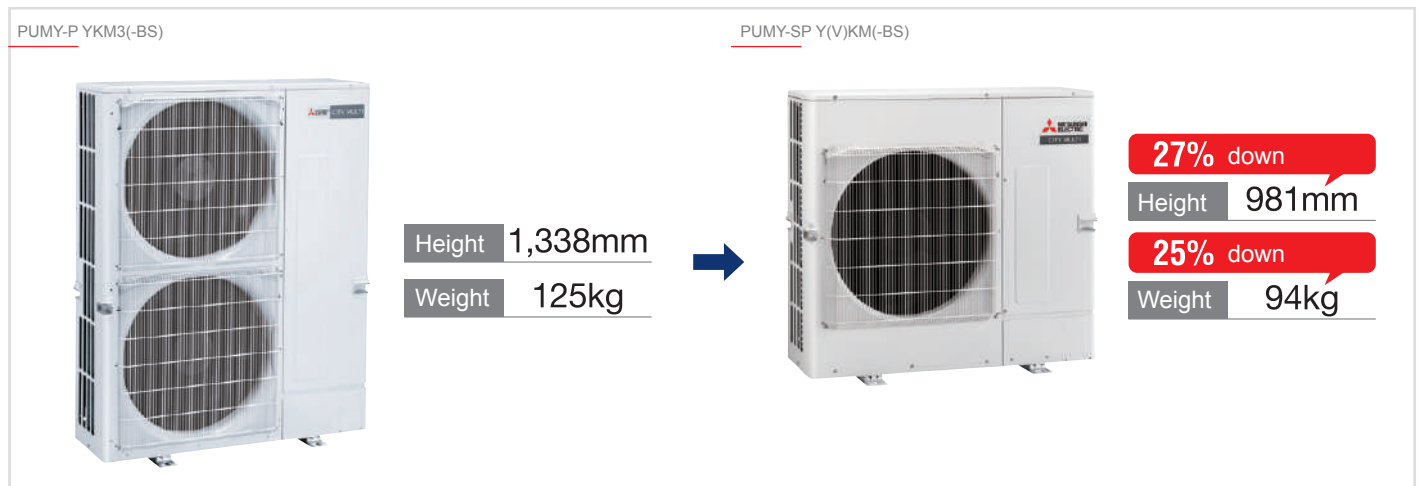

Easy installation and transport

The compact chassis of the SMALL Y COMPACT (PUMY-SP) and above all its low height (under one metre) make the machine suitable for installation on balconies. The low weight makes the unit easy to transport.

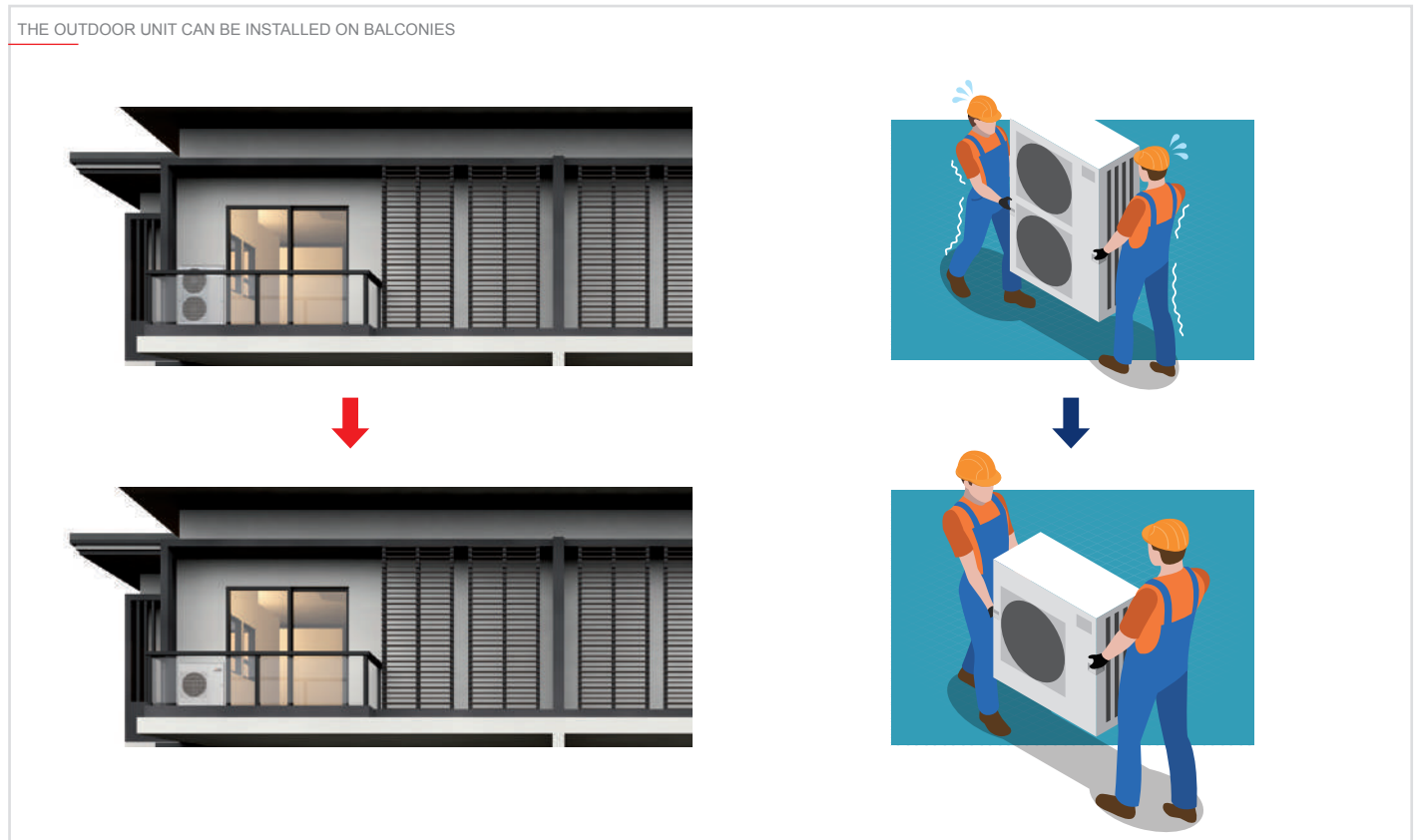

Top of the range efficiency

Despite its compact size and low weight, the new SMALL Y COMPACT (PUMY-SP) provides top of the range efficiency. This reduces operating costs.

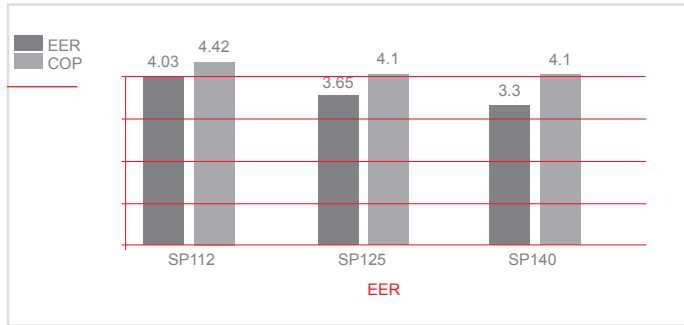

Super Silent Mode

The SMALL Y COMPACT (PUMY-SP) is the first model in the range that can operate in the new "Super Silent" mode, which reduces sound emission by -10dB(A). It is therefore possible to install the unit even in particularly sensitive acoustic environments.

*The optional PAC-SC36NA-E connector is required in order to activate "Super Silent" mode.
*System capacity is reduced if "Silent" or "Super Silent" mode is activated.

Geometric limits

The compactness of the new model SMALL Y COMPACT (PUMY-SP) does not affect the system's flexibility, so it is still possible to have extended and capillary pipe development.

GEOMETRIC LIMITS	
	PUMY-SP112/125/140 VKM(-BS)/YKM(-BS)
Total length of pipes	120 m
Total pipe length after branch box/boxes	95 m
Maximum level difference between UI and UE (UE above)	50 m
Maximum height difference between UI and UE (UE below)	30 m

Flexible connection

The new SMALL Y COMPACT line is equipped with front, side, rear and lower refrigeration connections, making it easier to install.

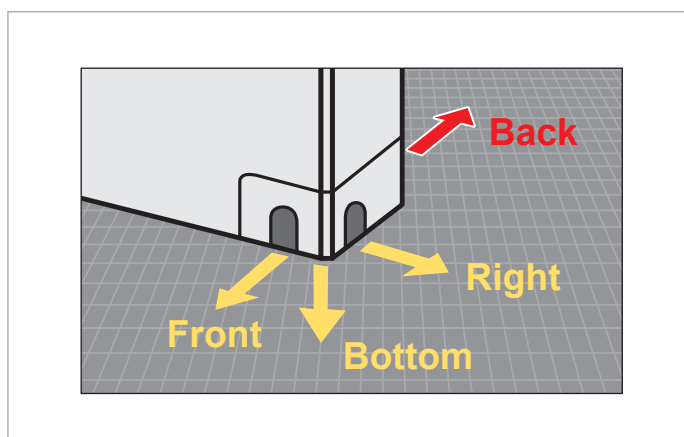

Static pressure outdoor fan unit

The 30 Pa static pressure option increases flexibility in the choice of the unit's installation point.

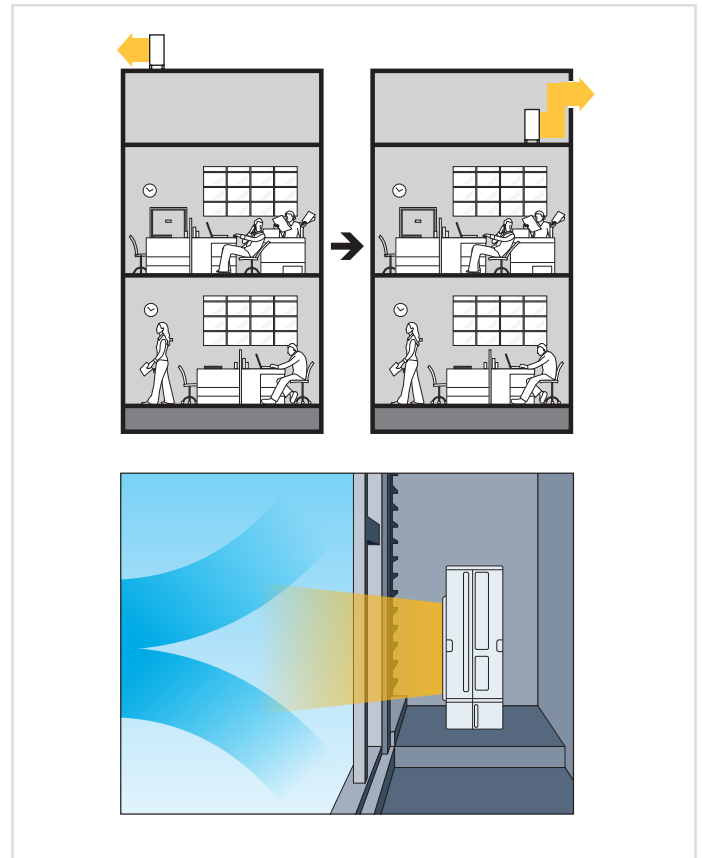

Connectivity

SMALL Y COMPACT (PUMY-SP) single-fan units can be connected to Residential and Commercial line indoor units by branch-box PAC-MK33(34)/53(54). It is also possible to create mixed systems with VRF indoor units and residential and commercial units. Thanks to these features, the system has essentially unlimited flexibility, serving every need.

New Branch Box (3 and 5 connections) - Total flexibility

The new Branch Boxes are designed to give the system the highest possible flexibility of configuration. It is therefore possible to create systems with CITY MULTI VRF units, consisting exclusively of Residential/Commercial Series indoor units or mixed systems in which the two types of units coexist.

SMALL Y LINE

OUTDOOR UNITS - PUMY-P Y(V)KM(-BS)



MORE QUIETNESS
THANKS TO THE NEW
FAN

CONNECTABLE
TO **ecodan** ATW
Renewable Heating Technology
MODULES FOR HOT
WATER PRODUCTION
UP TO 55°C

GEOMETRIC PIPING
LIMITATIONS
INCREASED

H.I.C. CIRCUIT (HEAT
INTER CHARGER)
FOR THE SUBCOOLING
CONTROL

HEATING OPERATION
RANGE EXTENDED UP
TO -20°C OUTDOOR
TEMPERATURE

TOP PERFORMANCE
AND COP > 4 ON THE
ENTIRE RANGE

POWER RANGE
4-5-6 HP
THREE-PHASE
AND SINGLE SIZE

NEW CHASSIS WITH
INCREASED HEAT
EXCHANGE SURFACE

INCREASED
RELIABILITY

CONNECTABLE TO
RESIDENTIAL AND
COMMERCIAL INDOOR
UNITS BY LEV-KIT AND
BRANCH BOX

NATIVE REPLACE
TECHNOLOGY
FUNCTION FOR THE
REPLACEMENT OF R22
SYSTEMS



New PUMY Y(V)KM 4(5) - The smallest, but with all the technology and efficiency of our bigger units

The SMALL Y (PUMY) series of outdoor units by Mitsubishi Electric, which now offers 7 different variants (with single and three-phase 4.5, 5 and 6 HP versions and a three-phase 8 HP version), is the ideal solution for large homes and medium-sized offices. These outdoor units may be connected to up to 12 indoor units of different type and power rating. This system offers exceptional savings in operating costs and is suitable for both residential and commercial applications.

Class-beating energy efficiency

The new SMALL Y (PUMY) series has been designed to offer extraordinary levels of energy efficiency in both summer (EER) and winter (COP) operation. The entire range scores **COP values above 4**, making these units usable even in regions where legislation sets more restrictive performance limitations.

Total comfort. Even at -20°C

The new SMALL Y (PUMY) series is now capable of operating in heating mode over an even broader temperature range (from -20 to +15 °C).

New chassis with larger heat exchange surface area

The new design of the SMALL Y (PUMY) series has made it possible to use a direct expansion coil with greater heat exchange surface area and density. Together with the introduction of the **Heat Inter Charger** overcooling circuit – a technological solution now appearing for the first time in units of this series – these improvements ensure superlative performance and extraordinary energy efficiency in cooling mode. The flat fin configuration of the coil and special Blue Fin treatment protect the

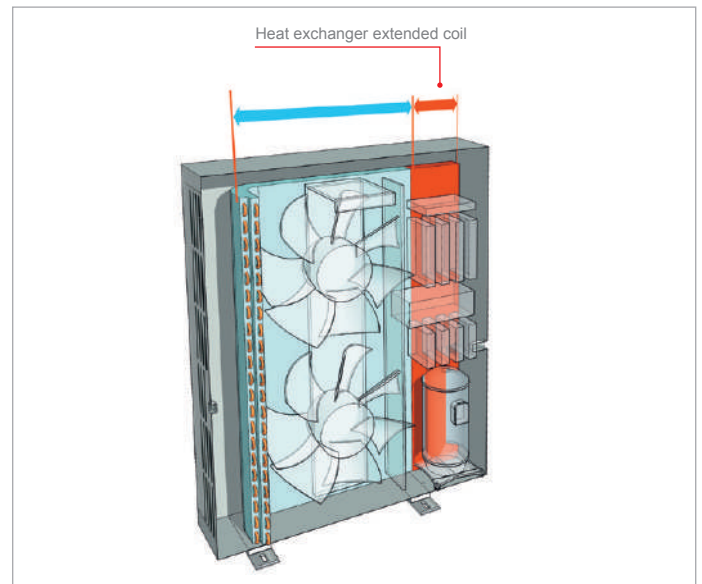

coil itself against corrosion, ensuring that the unit continues to function with the same outstanding thermal exchange efficiency and performance over time.

The power of a VRF, the elegance of a residential Multi-Split

With the **LEV KIT** and the new dedicated **Branch Box** (available as 3 and 5 connection versions), the outdoor units of the Small Y series can now be connected to the entire range of **residential and commercial** indoor units, with looks that are perfectly suited to applications (such as residential buildings and hotels) where design and elegance are decisive factors in the choice of indoor units.

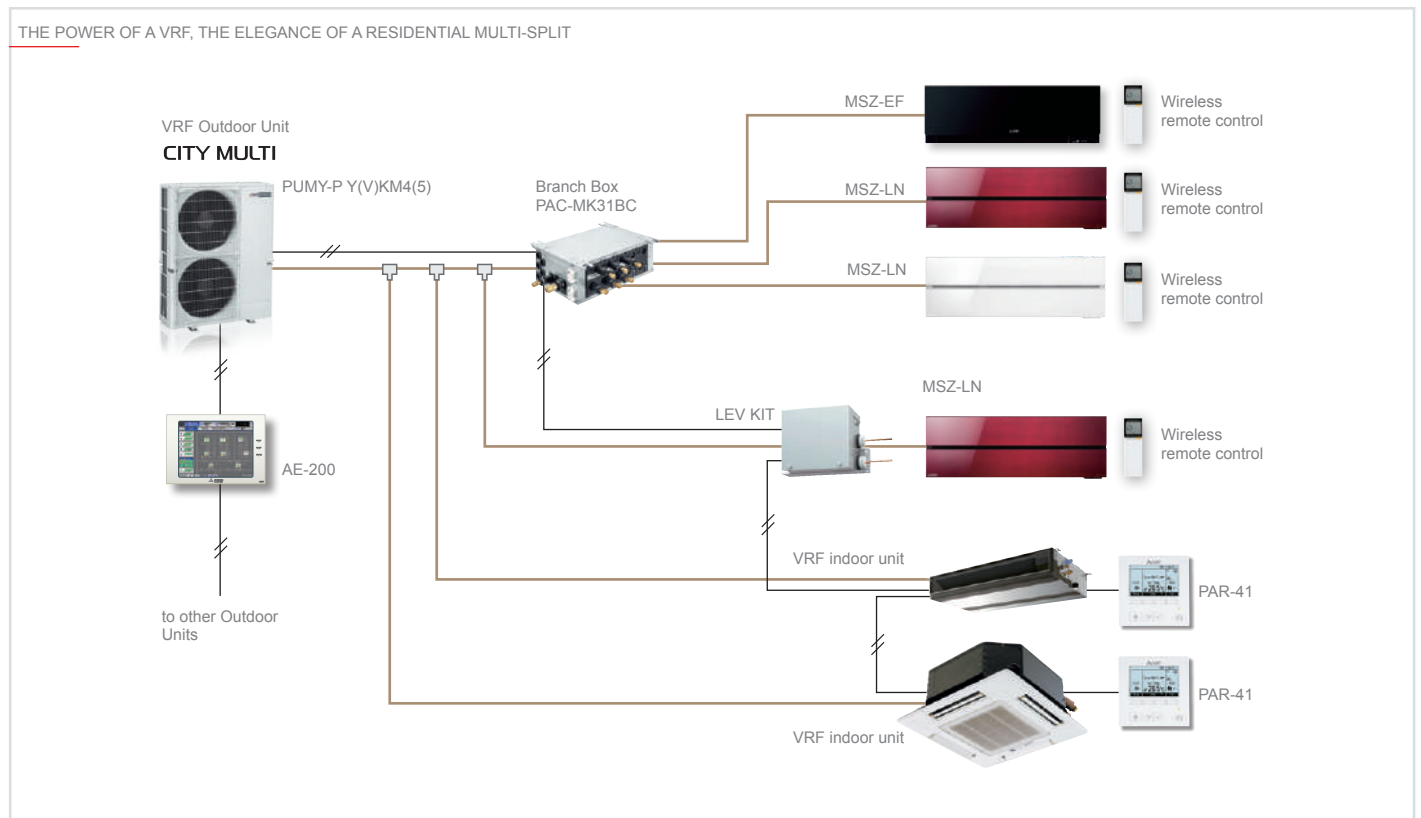

be used without modification, even with piping with different diameters and wall thicknesses. By using exclusive HAB oil and special low friction technology for the compressor, the majority of our air conditioners may operate with the original piping, cutting installation times and costs and material costs while minimising environmental impact.

AC PRE-HEATING compressor pre-heating system

AC pre-heating system is used for the compressor. The pre-heat routine is based on the temperature of the refrigerant and of the compressor. AC control reduces power absorption in stand-by state, increasing seasonal efficiency.

Technical specifications

MODEL			PUMY-P112VKM5(-BS)	PUMY-P125VKM5(-BS)	PUMY-P140VKM5(-BS)	
HP			4.5	5.0	6.0	
Power	Phases/Voltage/Freq.		Single phase 220-230-240V 50Hz			
Cooling	Nominal capacity*1		kW	12.5	14.0	15.5
	Power absorption		kW	2.79	3.46	4.52
	EER			4.48	4.05	3.43
	SEER			6.55	6.60	6.25
	Operating temperature range	Indoor WB	°C	15.0~24.0	15.0~24.0	15.0~24.0
Outdoor DB		°C	-5.0~46.0	-5.0~46.0	-5.0~46.0	
Heating	Nominal capacity*2		kW	14.0	16.0	18.0
	Power absorption		kW	3.04	3.74	4.47
	COP			4.61	4.28	4.03
	SCOP			4.64	4.63	4.42
	Operating temperature range	Indoor WB	°C	15.0~27.0	15.0~27.0	15.0~27.0
Outdoor DB		°C	-20.0~15.0	-20.0~15.0	-20.0~15.0	
Sound pressure*3	Heating mode		dB(A)	51	52	53
	Cooling mode		dB(A)	49	50	51
Connectable indoor units	Total capacity		50 to 130% of capacity of O.U.			
	Model/Quantity		P15~P140 / 1~9	P15~P140 / 1~10	P15~P140 / 1~12	
External diameter of refrigerant connectors	Liquid		mm	9.52	9.52	9.52
	Gas		mm	15.88	15.88	15.88
Fan air flow rate			m ³ /min	110	110	110
External dimensions (HxLxW)			mm	1338x1050x330	1338x1050x330	1338x1050x330
Net weight			kg	122	122	122
Ref. Charge R410A**/CO ₂ Eq			kg/Tons	4.8/10.02	4.8/10.02	4.8/10.02

*1 Nominal cooling conditions: Indoor: 27°C DB / 19°C WB. Outdoor 35°C DB. Piping length 7.5 m, vertical difference 0 m.

*2 Nominal heating conditions: Indoor 20°C DB. Outdoor 7°C DB / 6°C WB. Piping length 7.5 m, vertical difference 0 m.

*3 Values measured in anechoic chamber.

** GWP value of HFC R410A 2088 according to 517 / 2014.

The SEER and SCOP data are based on the EN14825 measurement standard

Technical specifications

MODEL			PUMY-P112YKM4R2(-BS)	PUMY-P125YKM4R2(-BS)	PUMY-P140YKM4R2(-BS)	
HP			4.5	5.0	6.0	
Power	Phases/Voltage/Freq.		3-phase, 380-400-415V, 50Hz			
Cooling	Nominal capacity*1		kW	12.5	14.0	15.5
	Power absorption		kW	2.79	3.46	4.52
	EER			4.48	4.05	3.43
	SEER			6.55	6.60	6.25
	Operating temperature range	Indoor WB	°C	15.0~24.0	15.0~24.0	15.0~24.0
Outdoor DB		°C	-5.0~46.0	-5.0~46.0	-5.0~46.0	
Heating	Nominal capacity*2		kW	14.0	16.0	18.0
	Power absorption		kW	3.04	3.74	4.47
	COP			4.61	4.28	4.03
	SCOP			4.64	4.63	4.42
	Operating temperature range	Indoor WB	°C	15.0~27.0	15.0~27.0	15.0~27.0
Outdoor DB		°C	-20.0~15.0	-20.0~15.0	-20.0~15.0	
Sound pressure*3	Heating mode		dB(A)	51	52	53
	Cooling mode		dB(A)	49	50	51
Connectable indoor units	Total capacity		50 to 130% of capacity of O.U.			
	Model/Quantity		P15~P140 / 1~9	P15~P140 / 1~10	P15~P140 / 1~11	
External diameter of refrigerant connectors	Liquid		mm	9.52	9.52	9.52
	Gas		mm	15.88	15.88	15.88
Fan air flow rate			m ³ /min	110	110	110
External dimensions (HxLxW)			mm	1338x1050x330	1338x1050x330	1338x1050x330
Net weight			kg	125	125	125
Ref. Charge R410A**/CO ₂ Eq			kg/Tons	4.8/10.02	4.8/10.02	4.8/10.02

*1 Nominal cooling conditions: Indoor: 27°C DB / 19°C WB. Outdoor 35°C DB. Piping length 7.5 m, vertical difference 0 m.

*2 Nominal heating conditions: Indoor 20°C DB. Outdoor 7°C DB / 6°C WB. Piping length 7.5 m, vertical difference 0 m.

*3 Values measured in anechoic chamber.

** GWP value of HFC R410A 2088 according to 517 / 2014.

The SEER and SCOP data are based on the EN14825 measurement standard

SMALL Y (HIGH CAPACITY) LINE

OUTDOOR UNITS - PUMY P200 YKM2 (-BS) / PUMY P250/300 YBM (BS)



MORE QUIETNESS
THANKS TO THE NEW
FAN

GEOMETRIC PIPING
LIMITATIONS
INCREASED

H.I.C. CIRCUIT (HEAT
INTER CHARGER)
FOR THE SUBCOOLING
CONTROL

HEATING OPERATION
RANGE EXTENDED UP
TO -20°C OUTDOOR
TEMPERATURE

TOP PERFORMANCE
AND COP > 4



POWER RANGE
EXTENDED WITH THE
INTRODUCTION
OF THE NEW 8, 10, 12 HP
THREE-PHASE SIZE

NEW CHASSIS WITH
INCREASED HEAT
EXCHANGE SURFACE

INCREASED
RELIABILITY

CONNECTABLE TO
RESIDENTIAL AND
COMMERCIAL INDOOR
UNITS BY LEV-KIT AND
BRANCH BOX

NATIVE REPLACE
TECHNOLOGY
FUNCTION FOR THE
REPLACEMENT OF R22
SYSTEMS

The power and performance of a VRF with the compact dimensions of a multisplit

The new PUMY-P200YKM 8HP is the ideal solution for all applications where there can be no compromise in efficiency, power and installation flexibility – even where installation space is limited.

The power of a VRF, the elegance of a residential Multi-Split

With the use of the **LEV KIT** and **Branch Box** (available as 3 and 5 connection versions) the outdoor units of the Small Y series in **8 HP** size can now be connected to the entire range of indoor units of the **residential and commercial series**, with looks that are perfectly suited to applications (residential and hotel buildings) where design and elegance are decisive factors in the choice of indoor units.

Branch Box (3-5 ports) - Total flexibility

New Branch Box grants high flexibility in system design and indoor unit choice. It is possible to connect Residential/Commercial units and/or CITY MULTI VRF units, realizing mixed systems with both types.

Note: PUMY-P200YKM2 to Branch Box connection is **only available in AtA configuration**.

Model	1 Branch Box		2 Branch Box	
	Branch Box ways	CITY MULTI Indoor Units	Branch Box ways	CITY MULTI Indoor Units
PUMY-P200	Max. 5	Max. 5	Max. 8	Max. 3

*The maximum total capacity of the units that can be connected to each branch box is 20.2kW

Indoor units connectable

Nr. IU Connectable Min/Max connectable capacity*	MODEL	Wall Mounted															Floor Standing	1 way cassette	4 way cassette				Ceiling Concealed				Ceiling Suspeded																							
		Kirigamine Style					Kirigamine Zen					Plus line							60x60 (Compact)		90x90 (Standard)		Low static pressure		Middle static pressure																									
		MSZ-LN- VG(2)	MSZ-EF VG(K)				MSZ-SF				MSZ-AP VG(K)				MSZ-GF VE	MFZ-KJ VE (2)	MFZ-KT VG	MLZ-KP VF	SLZ-M FA VA2	PLA-M EA		SEZ-M DA (L)		PEAD-M JA		PCA-M KA																								
		25	35	50	18	22	25	35	42	50	15	20	25	35	42	50	15	20	25	35	42	50	60	71	25	35	50	15	25	35	50	35	50	60	71	100	25	35	50	60	71	50	60	71	100	35	50	60	71	100
8	112/291	PUMY-P200																																																

* [KW]x10, COMPATIBILITY TABLE FOR MODELS PUMY P200 YKM2_ R1(2)

Note1: Only for R1/R2 models: MSZ-EF-VG, MSZ-AP-VG, PLA-M-EA

Note2: Only for R2 models: MSZ-LN-VG2, MSZ-AP-VGK, MSZ-EF-VGK, MFZ-KT-VG

Technical specifications

MODEL	PUMY-P200YKM2R2(-BS)												
HP	8												
Power	Phases/Voltage/Freq.		3-phase, 380-400-415V, 50Hz										
Cooling	Capacity*1		kW										
	Power input		kW										
	EER		3.70										
	SEER		5.45										
	Temperature operating field	Indoor WB	°C										
	Outdoor DB	°C											
			-5.0~52.0 *2*3										
Heating	Capacity*4		kW										
	Power input		kW										
	COP		5.84										
	SCOP		4.28										
	Temperature operating field	Indoor WB	°C										
	Outdoor DB	°C											
			-20.0~15.0										
Sound power level*5			dB(A)										
			56/61										
Connectable indoor units			50~130% of kW outdoor unit capacity										
	Model/ Quantity	CITY MULTI		P15-P200/12									
		Branch Box		kW index: 15-100/8*6									
		Mixed system	1 Branch Box		CITY MULTI		P15-P200/5						
					Branch Box		kW index: 15-100/5						
2 Branch Box			CITY MULTI		P15-P200/3								
			Branch Box		kW index: 15-100/8								
Ø Ref. piping	Liquid/Gas		mm										
			9.52/19.05										
External dimensions (HxLxW)			mm										
			1338 x 1050 x 330										
Net weight			kg										
			141										
Ref. Charge R410A**/CO ₂ Eq			kg/Tons										
			7.3/15.24										

*1 Nominal cooling conditions.: Indoor: 27°C DB / 19°C WB. Outdoor 35°C DB. Piping length 7.5 m., vertical difference 0 m.

*2 10 to 52.: when connecting following models: PKFY-P15/20/25VBM,

PKFY-P10/15/20/25/32VLM, PFFY-P20/25/32VLEM, PFFY-P20/25/32VLRM(M), PFFY-P20/25/32VKM, PFFY-P20/25/32VCM, and M series, S series, and P series type indoor unit.

*3 15.0~52.0 when using accessory PAC-SH95AG-E. Not available when connecting units listed in*2

*4 Nominal heating conditions: Indoor 20°C DB. Outdoor 7°C DB / 6°C WB. Piping length 7.5 m, vertical difference 0 m.

*5 Values measured in anechoic chamber (Cooling/Heating)

*6 At least 2 IU connected to Branch Box.

*7 GWP value of HFC R410A 2088 according to 517 / 2014.

The SEER and SCOP data are based on the EN14825 measurement standard

The power and performance of a VRF with the compact dimensions of a multisplit

The new PUMY-P250/300 YKB 10-12 HP is the ideal solution for all applications where there can be no compromise in efficiency, power and installation flexibility – even where installation space is limited.

Model	1 Branch Box		2 Branch Box		3 Branch Box	
	Branch Box ways	CITY MULTI Indoor Units	Branch Box ways	CITY MULTI Indoor Units	Branch Box ways	CITY MULTI Indoor Units
PUMY-P250	Max. 5	Max. 25	Max. 10	Max. 23	Max. 12	Max. 22
PUMY-P300	Max. 5	Max. 25	Max. 10	Max. 23	Max. 12	Max. 22

*The maximum total capacity of the units that can be connected to each branch box is 20.2kW

The power of a VRF, the elegance of a residential Multi-Split

With the use of the **LEV KIT** and **Branch Box** (available as 3 and 5 connection versions) the outdoor units of the Small Y series in **10/12 HP** size can now be connected to the entire range of indoor units of the **residential and commercial series**, with looks that are perfectly suited to applications (residential and hotel buildings) where design and elegance are decisive factors in the choice of indoor units.

Installation flexibility

The 10 and 12HP models introduce further installation flexibility by ensuring connection of the refrigerant also from the rear of the unit, making these models adaptable to all application requirements.

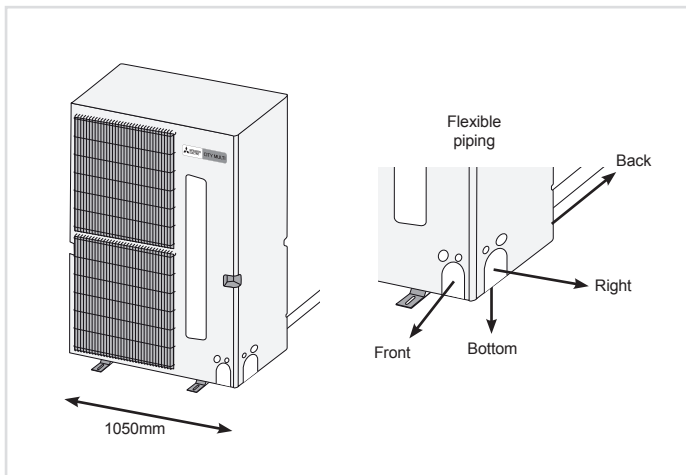

Branch Box (3-5 ports) - Total flexibility

New Branch Box grants high flexibility in system design and indoor unit choice. It is possible to connect Residential/Commercial units and/or CITY MULTI VRF units, realizing mixed systems with both types.

Note: PUMY-P250/300 YBM to Branch Box connection is **only available in AtA configuration**.

The new 10 and 12HP models

The SMALL Y Line gets enriched by the addition of new models (10 and 12HP) in response to the increasing market need for a compact machine that covers bigger capacity.

The PUMY P250/300 YBM outdoor units are available in a single version with three-phase power supply, double fan structure, side-flow and with different sizes depending on the model. Also available in -BS version, with anti-saline treatment.

Side Flow vs Top Flow

Side-flow outdoor units have a smaller footprint and volume than Top-flow units.



Indoor units connectable

			Wall Mounted															Floor Standing		
Nr. IU Connectable	Min/Max connectable capacity*	MODEL	Kirigamine Style					Kirigamine Zen					Plus line							
			MSZ-LN- VG(2)			MSZ-EF VG(K)					MSZ-AP VG(K)					MFZ-KT VG				
			25	35	50	18	22	25	35	42	50	15	20	25	35	42	50	25	35	50
12	140/364	PUMY-P250	•	•	•	•	•	•	•	•	•	•	•	•	•	•	•	•	•	•
	168/435	PUMY-P300	•	•	•	•	•	•	•	•	•	•	•	•	•	•	•	•	•	•

* [kW]x10, COMPATIBILITY TABLE FOR MODELS PUMY P250/300 YBM

Technical specifications

MODEL			PUMY-P250YBM(-BS)				PUMY-P300YBM(-BS)							
HP			10				12							
Power	Phases/Voltage/Freq.		3-phase, 380-400-415V, 50Hz				3-phase, 380-400-415V, 50Hz							
Cooling	Capacity*1		kW		28				33,5					
	Power input		kW		8,21				10,12					
	EER				3.41				3.31					
	SEER				6.28				6.28					
	Temperature operating field		Indoor WB	°C	15.0~24.0				15.0~24.0					
		Outdoor DB	°C	-5.0~52.0 *3*4				-5.0~52.0 *3*4						
Heating	Capacity*2		kW		31,5				37,5					
	Power input		kW		7,41				9,12					
	COP				4.25				4.11					
	SCOP				4.22				4.22					
	Temperature operating field		Indoor WB	°C	15.0~27.0				15.0~27.0					
		Outdoor DB	°C	-20.0~15.0				-20.0~15.0						
Sound power level			dB(A)		56/61				57/62					
Connectable indoor units			50~130% of kW outdoor unit capacity				50~130% of kW outdoor unit capacity							
	Model/ Quantity	CITY MULTI			P10-P250/30				P10-P250/30					
		Branch Box			kW index: 15-50/12				kW index: 15-50/12					
		Mixed system	1 Branch Box	CITY MULTI			P10-P250/25				P10-P250/25			
			Branch Box			kW index: 15-50/5				kW index: 15-50/5				
		2 Branch Box	CITY MULTI			P10-P250/23				P10-P250/23				
		Branch Box			kW index: 15-50/10				kW index: 15-50/10					
3 Branch Box		CITY MULTI			P10-P250/22				P10-P250/22					
Branch Box			kW index: 15-50/12				kW index: 15-50/12							
Ø Ref. piping	Liquid/Gas		mm		9.52/22.4*5				12.7/25.4*5					
External dimensions (HxLxW)			mm		1662 x 1050 x460				1662 x 1050 x460					
Net weight			kg		196				196					
Ref. Charge R410A/CO ₂ Eq			kg/Tons		9.3/19,41				9.3/19,41					

*1. Nominal cooling conditions (subject to ISO 15042)

Indoor: 27°CDB./19°CWB. (81°FDB./66°FWB.), Outdoor: 35°CDB. [95°FDB.], Pipe length: 7.5 m [24-9/16 ft.], Level difference: 0 m [0 ft.]

*2. Nominal heating conditions (subject to ISO 15042)

Indoor: 20°CDB. [68°FDB.], Outdoor: 7°CDB./6°CWB. [45°FDB./43°FWB.], Pipe length: 7.5 m [24-9/16 ft.], Level difference: 0 m [0 ft.]

*3. 10 to 52°C, when connecting following models: PKFY-P10/15/20/25/32VLM, PFFY-P20/25/32VKM, PFFY-P20/25/32VCM, PFFY-P20/25/32VLEM, PEFY-P63/71/80V/MA3-E; and M series type indoor unit.

*4. -15 to 52°C, when using an optional air protect guide [PAC-SK21AG-E]. However, this condition does not apply to the indoor unit listed in *3.

*5. Liquid pipe diameter: 12.7mm, when further piping length is longer than 90m, and when PEFY-P200 or P250 is connected.

It is possible to set the External static pressure to 30 Pa by Dip Switch.

Notes:

• Nominal conditions *1, *2 are subject to ISO15042

• Due to continuing improvement, above specifications may be subject to change without notice.

Y ECOSTANDARD LINE

OUTDOOR UNITS - PUHY-P Y(S)KA(-BS)



OUTDOOR UNIT
OPTIMISED
FOR COOLING
PERFORMANCE (EER)

SINGLE MODULE
SYSTEM FOR
INSTALLATIONS UP TO
20HP, FOR MINIMISED
SPACE USAGE AND
EXTREME SIMPLICITY
OF INSTALLATION

EXTENDED
OPERATING RANGE
IN COOLING MODE,
WITH MAXIMUM
TEMPERATURES UP
TO 52°C

MAX SIZE UP TO 60 HP

EVAPORATING
TEMPERATURE
CONTROL SYSTEM
(E.T.C.)



NEW FLANGED
DUCT AND NEW DC
INVERTER FAN MOTOR

MORE COMPACT
AND LIGHTER THAN
YHA OUTDOOR UNIT
SERIES

CONVENTIONAL
BI-METAL (COPPER/
ALUMINIUM) HEAT
EXCHANGER

EXTENDED PIPING
LENGTH

MODEL Single			PUHY-P200YKA(-BS)	PUHY-P250YKA(-BS)	PUHY-P300YKA(-BS)	PUHY-P350YKA(-BS)	PUHY-P400YKA(-BS)	PUHY-P450YKA(-BS)	PUHY-P500YKA(-BS)
HP			8	10	12	14	16	18	20
Power supply	Tens./Freq./Phase	V/Hz/n*	3 phase 380-400-415 50Hz						
Cooling	Capacity ^{*1}	kW	22.4	28	33.5	40	45	48	55
	Power input	kW	5,19	6,89	8,86	11,69	13,55	15,78	18,39
	EER		4,31	4,06	3,78	3,42	3,32	3,04	2,99
	SEER		7.12	7.28	6.39	6.67	6.30	6.13	6.44
	Temperature operating field	Indoor WB	°C	15~24	15~24	15~24	15~24	15~24	15~24
Outdoor DB		°C	-5~52	-5~52	-5~52	-5~52	-5~52	-5~52	-5~52
Heating	Capacity ^{*2}	kW	22.4	28	33.5	40	45	48	55
	Power input	kW	5,05	6,33	8,11	9,61	10,92	13,33	15,71
	COP		4,43	4,42	4,13	4,16	4,12	3,6	3,5
	SCOP		4.12	3.87	3.92	3.56	3.50	3.50	3.51
	Temperature operating field	Indoor WB	°C	15~27	15~27	15~27	15~27	15~27	15~27
Outdoor DB		°C	-20~15,5	-20~15,5	-20~15,5	-20~15,5	-20~15,5	-20~15,5	-20~15,5
Sound pressure level ^{*3}			57	58	61	61	63	63	65
Connectable indoor units	Total capacity		50 to 130% of O.U. capacity	50 to 130% of O.U. capacity	50 to 130% of O.U. capacity	50 to 130% of O.U. capacity	50 to 130% of O.U. capacity	50 to 130% of O.U. capacity	50 to 130% of O.U. capacity
	Model/Quantity		P15-P250/1~17	P15-P250/1~21	P15-P250/1~26	P15-P250/1~30	P15-P250/1~34	P15-P250/1~39	P15-P250/1~43
Ø Ref. piping diameter	Liquid/Gas		9,52/22,2	9,52/22,2	9,52/22,2	9,52/28,58	12,7/28,58	15,88/28,58	15,88/28,58
External dimention	(HxLxD)	mm	1650x920x740	1650x920x740	1650x920x740	1650x1220x740	1650x1220x740	1650x1220x740	1650x1750x740
Net weight			195	195	211	256	253	253	288
Ref. Charge R410 ^{*4} /CO ₂ Eq			8/16,7	8/16,7	8/16,7	11,5/24,01	11,5/24,01	11,5/24,01	11,8/24,64

MODEL Double			PUHY-P550YKA(-BS)	PUHY-P600YKA(-BS)	PUHY-P650YKA(-BS)	PUHY-P700YKA(-BS)	PUHY-P750YKA(-BS)	PUHY-P800YKA(-BS)
HP			22	24	26	28	30	32
Modules			PUHY-P250YKA PUHY-P300YKA	PUHY-P250YKA PUHY-P350YKA	PUHY-P250YKA PUHY-P400YKA	PUHY-P250YKA PUHY-P450YKA	PUHY-P300YKA PUHY-P450YKA	PUHY-P400YKA PUHY-P400YKA
Twinning joint			CMY-Y100VBK3	CMY-Y100VBK3	CMY-Y100VBK3	CMY-Y200VBK2	CMY-Y200VBK2	CMY-Y200VBK2
Power supply	Tens./Freq./Phase	V/Hz/n*	3 phase 380-400-415 50Hz					
Cooling	Capacity ^{*1}	kW	63	68	73	76	81,5	90
	Power input	kW	16,07	18,18	19,78	21,4	23,9	27,1
	EER		3,92	3,74	3,69	3,55	3,41	3,32
	SEER		6,67	6,79	6,75	6,14	5,70	6,44
	Temperature operating field	Indoor WB	°C	15~24	15~24	15~24	15~24	15~24
Outdoor DB		°C	-5~52	-5~52	-5~52	-5~52	-5~52	-5~52
Heating	Capacity ^{*2}	kW	63	68	73	76	81,5	90
	Power input	kW	15,51	16,7	18,02	20	22,2	23,01
	COP		4,06	4,07	4,05	3,8	3,67	3,91
	SCOP		3,76	3,81	3,57	3,45	3,40	3,38
	Temperature operating field	Indoor WB	°C	15~27	15~27	15~27	15~27	15~27
Outdoor DB		°C	-20~15,5	-20~15,5	-20~15,5	-20~15,5	-20~15,5	-20~15,5
Sound pressure level ^{*3}			63	63	64,5	64,5	65,5	66
Connectable indoor units	Total capacity		50 to 130% of O.U. capacity	50 to 130% of O.U. capacity	50 to 130% of O.U. capacity	50 to 130% of O.U. capacity	50 to 130% of O.U. capacity	50 to 130% of O.U. capacity
	Model/Quantity		P15-P250/2~47	P15-P250/2~50	P15-P250/2~50	P15-P250/2~50	P15-P250/2~50	P15-P250/2~50
Ø Ref. piping diameter	Liquid/Gas		15,88/28,58	15,88/28,58	15,88/28,58	19,05/34,93	19,05/34,93	19,05/34,93
External dimention	(HxLxD)	mm	1650x920x740 1650x920x740	1650x920x740 1650x1220x740	1650x920x740 1650x1220x740	1650x920x740 1650x1220x740	1650x920x740 1650x1220x740	1650x1220x740 1650x1220x740
Net weight			406	451	448	448	464	506
Ref. Charge R410 ^{*4} /CO ₂ Eq			16/33,4	19,5/33,4	19,5/33,4	19,5/48,02	19,5/48,02	23/48,02

*1 Nominal cooling conditions: Indoor: 27°C DB / 19°C WB. Outdoor 35°C DB. Piping length 7.5 m, vertical difference 0 m.

*2 Nominal heating conditions: Indoor 20°C DB. Outdoor 7°C DB / 6°C WB. Piping length 7.5 m, vertical difference 0 m.

*3 Values measured in anechoic chamber.

*4 GWP value of HFC R410A 2088 according to 517 / 2014.

Technical specifications

MODEL Double			PUHY-P850YKA(-BS)	PUHY-P900YKA(-BS)	PUHY-P950YKA(-BS)	PUHY-P1000YKA(-BS)
HP			34	36	38	40
Modules			PUHY-P400YKA PUHY-P450YKA	PUHY-P450YKA PUHY-P450YKA	PUHY-P450YKA PUHY-P500YKA	PUHY-P500YKA PUHY-P500YKA
Twinning joint			CMY-Y200VBK2	CMY-Y200VBK2	CMY-Y200VBK2	CMY-Y200VBK2
Power supply	Tens./Freq./Phase	V/Hz/n°	3 phase 380-400-415 50Hz			
Cooling	Capacity*1	kW	93	96	103	110
	Power input	kW	29,24	31,57	34,21	36,78
	EER		3,18	3,04	3,01	2,99
	SEER		6,14	5,98	6,21	6,63
	Temperature operating field	Indoor WB	°C	15~24	15~24	15~24
Outdoor DB		°C	-5~52	-5~52	-5~52	-5~52
Heating	Capacity*2	kW	93	96	103	110
	Power input	kW	25,4	28,07	30,56	33,13
	COP		3,66	3,42	3,37	3,32
	SCOP		3,40	3,39	3,61	3,61
	Temperature operating field	Indoor WB	°C	15~27	15~27	15~27
Outdoor DB		°C	-20~15,5	-20~15,5	-20~15,5	-20~15,5
Sound pressure level*3		dB(A)	66	66	67,5	68
Connectable indoor units	Total capacity		50 to 130% of O.U. capacity	50 to 130% of O.U. capacity	50 to 130% of O.U. capacity	50 to 130% of O.U. capacity
	Model/Quantity		P15-P250/2-50	P15-P250/2-50	P15-P250/2-50	P15-P250/2-50
Ø Ref. piping diameter	Liquid/Gas		19,05/41,28	19,05/41,28	19,05/41,28	19,05/41,28
External dimentions	(HxLxD)	mm	1650x1220x740 1650x1220x740	1650x1220x740 1650x1220x740	1650x1220x740 1650x1750x740	1650x1750x740 1650x1750x740
Net weight		kg	506	506	541	576
Ref. Charge R410**/ CO ₂ Eq		kg/Tons	23/48,02	23/48,02	23,3/48,65	23,6/49,28

Technical specifications

MODEL Triple			PUHY-P1050YKA(-BS)	PUHY-P1100YKA(-BS)	PUHY-P1150YKA(-BS)	PUHY-P1200YKA(-BS)	PUHY-P1250YKA(-BS)	PUHY-P1300YKA(-BS)
HP			42	44	46	48	50	52
Modules			PUHY-P300YKA PUHY-P300YKA PUHY-P450YKA	PUHY-P300YKA PUHY-P350YKA PUHY-P450YKA	PUHY-P350YKA PUHY-P400YKA PUHY-P400YKA	PUHY-P400YKA PUHY-P400YKA PUHY-P400YKA	PUHY-P400YKA PUHY-P400YKA PUHY-P450YKA	PUHY-P400YKA PUHY-P450YKA PUHY-P450YKA
Twinning joint			CMY-Y300VBK3	CMY-Y300VBK3	CMY-Y300VBK3	CMY-Y300VBK3	CMY-Y300VBK3	CMY-Y300VBK3
Power supply	Tens./Freq./Phase	V/Hz/n°	3 phase 380-400-415 50Hz					
Cooling	Capacity*1	kW	115	121,5	130	135	138	141
	Power input	kW	32,57	35,63	38,8	40,66	43,12	45,77
	EER		3,53	3,41	3,35	3,32	3,2	3,08
	SEER		5,96	5,97	6,41	6,50	6,41	6,02
	Temperature operating field	Indoor WB	°C	15~24	15~24	15~24	15~24	15~24
Outdoor DB		°C	-5~52	-5~52	-5~52	-5~52	-5~52	-5~52
Heating	Capacity*2	kW	115	121,5	130	135	138	141
	Power input	kW	31,5	33,8	35,51	37,7	40,35	42,98
	COP		3,65	3,59	3,66	3,58	3,42	3,28
	SCOP		3,47	3,42	3,42	3,41	3,40	3,40
	Temperature operating field	Indoor WB	°C	15~27	15~27	15~27	15~27	15~27
Outdoor DB		°C	-20~15,5	-20~15,5	-20~15,5	-20~15,5	-20~15,5	-20~15,5
Sound pressure level*3		dB(A)	66,5	66,5	67,5	68	68	68
Connectable indoor units	Total capacity		50 to 130% of O.U. capacity	50 to 130% of O.U. capacity	50 to 130% of O.U. capacity	50 to 130% of O.U. capacity	50 to 130% of O.U. capacity	50 to 130% of O.U. capacity
	Model/Quantity		P15-P250/2-50	P15-P250/2-50	P15-P250/2-50	P15-P250/2-50	P15-P250/2-50	P15-P250/2-50
Ø Ref. piping diameter	Liquid/Gas		19,05/41,28	19,05/41,28	19,05/41,28	19,05/41,28	19,05/41,28	19,05/41,28
External dimentions	(HxLxD)	mm	1650x920x740 1650x920x740 1650x1220x740	1650x920x740 1650x1220x740 1650x1220x740	1650x1220x740 1650x1220x740 1650x1220x740	1650x1220x740 1650x1220x740 1650x1220x740	1650x1220x740 1650x1220x740 1650x1220x740	1650x1220x740 1650x1220x740 1650x1220x740
Net weight		kg	675	720	762	759	759	759
Ref. Charge R410**/ CO ₂ Eq		kg/Tons	27/57,41	31/64,72	34,5/72,03	34,5/72,03	34,5/72,03	34,5/72,03

Technical specifications				PUHY-P1350YKA(-BS)	PUHY-P1400YKA(-BS)	PUHY-P1450YKA(-BS)	PUHY-P1500YKA(-BS)
MODEL Triple				54	56	58	60
HP			54	56	58	60	
Modules			PUHY-P450YKA PUHY-P450YKA PUHY-P450YKA	PUHY-P450YKA PUHY-P450YKA PUHY-P500YKA	PUHY-P450YKA PUHY-P500YKA PUHY-P500YKA	PUHY-P500YKA PUHY-P500YKA PUHY-P500YKA	
Twinning joint			CMY-Y300VBK3	CMY-Y300VBK3	CMY-Y300VBK3	CMY-Y300VBK3	
Power supply	Tens./Freq./Phase	V/Hz/n°	3 phase 380-400-415 50Hz				
Cooling	Capacity ^{*1}	kW	144	151	158	165	
	Power input	kW	48,64	52,24	55,83	59,56	
	EER		2,96	2,89	2,83	2,77	
	SEER		5,91	6,23	6,34	6,44	
	Temperature operating field	Indoor WB	°C	15~24	15~24	15~24	15~24
Outdoor DB		°C	-5~52	-5~52	-5~52	-5~52	
Heating	Capacity ^{*2}	kW	144	151	158	165	
	Power input	kW	46,15	49,5	52,49	56,12	
	COP		3,12	3,05	3,01	2,94	
	SCOP		3,39	3,50	3,51	3,51	
	Temperature operating field	Indoor WB	°C	15~27	15~27	15~27	15~27
Outdoor DB		°C	-20~15,5	-20~15,5	-20~15,5	-20~15,5	
Sound pressure level ^{*3}			68	68,5	69,5	70	
Connectable indoor units	Total capacity			50 to 130% of O.U. capacity	50 to 130% of O.U. capacity	50 to 130% of O.U. capacity	50 to 130% of O.U. capacity
	Model/Quantity			P15-P250/2-50	P15-P250/2-50	P15-P250/2-50	P15-P250/2-50
Ø Ref. piping diameter	Liquid/Gas			19,05/41,28	19,05/41,28	19,05/41,28	19,05/41,28
External dimensions	(HxLxD)	mm	1650x1220x740	1650x1220x740	1650x1220x740	1650x1750x740	
			1650x1220x740	1650x1220x740	1650x1750x740	1650x1750x740	
			1650x1220x740	1650x1750x740	1650x1750x740	1650x1750x740	
Net weight			kg	759	759	829	864
Ref. Charge R410 ^{**} /CO ₂ Eq			kg/Tons	34,5/72,03	34,8/72,66	35,1/73,29	35,4/73,92

Key Technologies									
									

Y HIGH EFFICIENCY

OUTDOOR UNITS - PUHY-EP YLM-A1 / YSLM-A1(-BS)



OUTDOOR UNIT
OPTIMIZED FOR MAXIMUM
PERFORMANCE AT NOMINAL
LOAD CONDITIONS

EXTENDED OPERATING
RANGE IN COOLING
MODE, WITH MAXIMUM
TEMPERATURES UP TO 52°C



CONTINUOUS
HEATING

SINGLE MODULE
SYSTEM FOR
INSTALLATIONS UP TO
14HP

EVAPORATING
TEMPERATURE
CONTROL SYSTEM
(E.T.C.)

MODEL Single			PUHY-EP200YLM-A1(-BS)	PUHY-EP250YLM-A1(-BS)	PUHY-EP300YLM-A1(-BS)	PUHY-EP350YLM-A1(-BS)	PUHY-EP400YLM-A1(-BS)	PUHY-EP450YLM-A1(-BS)	PUHY-EP500YLM-A1(-BS)
HP			8	10	12	14	16	18	20
Power supply	Tens./Freq./Phase	V/Hz/n°	3 phase 380-400-415 50Hz						
Cooling	Capacity*1	kW	22.4	28.0	33.5	40.0	45.0	50.0	56.0
	Power input	kW	5.19	6.89	8.56	11.69	12.26	14.79	18.72
	EER		4.31	4.06	3.91	3.42	3.67	3.38	2.99
	SEER		6.52	6.70	5.98	5.70	5.79	5.67	5.49
	Temperature operating field	Indoor WB °C	15.0~24.0						
	Outdoor DB °C	-5.0~52.0							
Heating	Capacity*2	kW	25.0	31.5	37.5	45.0	50.0	56.0	63.0
	Power input	kW	5.73	7.68	9.16	12.53	13.15	16.09	19.68
	COP		4.36	4.10	4.09	3.59	3.80	3.48	3.20
	SCOP		3.90	3.66	3.47	3.29	3.36	3.22	3.04
	Temperature operating field	Indoor WB °C	15.0~27.0						
	Outdoor DB °C	-20.0~15.5							
Sound pressure level*3		dB(A)	57	60	61	61	62.5	63	63.5
Connectable indoor units	Total capacity	50 to 130% of O.U. capacity							
	Model/Quantity		P15-P250/1~17	P15-P250/1~21	P15-P250/1~26	P15-P250/1~30	P15-P250/1~34	P15-P250/1~39	P15-P250/1~43
Ø Ref. piping diameter	Liquid/Gas		9.52/22.2	9.52/22.2	9.52/28.58	12.7/28.58	12.7/28.58	15.88/28.58	15.88/28.58
External dimensions	(HxLxD)	mm	1710 x 920 x 740	1710 x 920 x 740	1710 x 1220 x 740	1710 x 1220 x 740	1710 x 1750 x 740	1710 x 1750 x 740	1710 x 1750 x 740
Net weight		kg	200	200	243	237	306	306	318
Ref. Charge R410**/CO ₂ Eq		kg/Tons	7.5 /15.66	7.5 /15.66	10.3/ 21.51	10.3/ 21.51	11.8 /24.64	11.8 /24.64	11.8 /24.64

MODEL Double/Triple			PUHY-EP550YSLM-A1(-BS)	PUHY-EP600YSLM-A1(-BS)	PUHY-EP650YSLM-A1(-BS)	PUHY-EP700YSLM-A1(-BS)	PUHY-EP750YSLM-A1(-BS)	PUHY-EP800YSLM-A1(-BS)
HP			22	24	26	28	30	32
Modules			PUHY-EP(250+300) YLM-A	PUHY-EP(300+300) YLM-A	PUHY-EP(200+200+250) YLM-A	PUHY-EP(200+200+300) YLM-A	PUHY-EP(200+250+300) YLM-A	PUHY-EP(200+300+300) YLM-A
Twinning joint			CMY-Y100VBK3					
Power supply	Tens./Freq./Phase	V/Hz/n°	3 phase 380-400-415 50Hz					
Cooling	Capacity*1	kW	63.0	69.0	73.0	80.0	85.0	90.0
	Power input	kW	16.62	18.59	18.15	20.15	21.85	23.43
	EER		3.79	3.71	4.02	3.97	3.89	3.84
	SEER		6.17	5.82	6.40	6.17	6.23	5.99
	Temperature operating field	Indoor WB °C	15.0~24.0					
	Outdoor DB °C	-5.0~52.0						
Heating	Capacity*2	kW	69.0	76.5	81.5	88.0	95.0	100.0
	Power input	kW	17.73	19.66	20.07	21.67	23.92	25.18
	COP		3.89	3.89	4.06	4.06	3.97	3.97
	SCOP		3.57	3.47	3.82	3.76	3.68	3.61
	Temperature operating field	Indoor WB °C	15.0~27.0					
	Outdoor DB °C	-20.0~15.5						
Sound pressure level*3		dB(A)	63.5	64	63	63.5	64.5	65
Connectable indoor units	Total capacity	50 to 130% of O.U. capacity						
	Model/Quantity		P15-P250/2~47	P15-P250/2~50	P15-P250/2~50	P15-P250/2~50	P15-P250/2~50	P15-P250/2~50
Ø Ref. piping diameter	Liquid/Gas		15.88/28.58	15.88/28.58	15.88/28.58	19.05/34.93	19.05/34.93	19.05/34.93
External dimensions	(HxLxD)	mm	1710 x 920 x 740 1710 x 1220 x 740	1710 x 1220 x 740 1710 x 1220 x 740	1710 x 920 x 740 1710 x 920 x 740 1710 x 920 x 740	1710 x 920 x 740 1710 x 920 x 740 1710 x 1220 x 740	1710 x 920 x 740 1710 x 920 x 740 1710 x 1220 x 740	1710 x 920 x 740 1710 x 1220 x 740 1710 x 1220 x 740
Net weight		kg	443	486	600	643	643	686
Ref. Charge R410**/CO ₂ Eq		kg/Tons	17.8 /37.17	20.6 /43.01	22.5 /46.98	25.3 /52.83	25.3 /52.83	28.1 /58.67

*1 Nominal cooling conditions: Indoor: 27°C DB / 19°C WB. Outdoor 35°C DB. Piping length 7.5 m, vertical difference 0 m.

*2 Nominal heating conditions: Indoor 20°C DB. Outdoor 7°C DB / 6°C WB. Piping length 7.5 m, vertical difference 0 m.

*3 Values measured in anechoic chamber.

*4 GWP value of HFC R410A 2088 according to 517 / 2014.

SCOP, SEER calculated according to Eurovent.

Technical specifications

MODEL Triple			PUHY-EP850YSLM-A1(-BS)	PUHY-EP900YSLM-A1(-BS)	PUHY-EP950YSLM-A1(-BS)	PUHY-EP1000YSLM-A1(-BS)	PUHY-EP1050YSLM-A1(-BS)	PUHY-EP1100YSLM-A1(-BS)
HP			34	36	38	40	42	44
Modules			PUHY-EP(250+300+300) YLM-A	PUHY-EP(300+300+300) YLM-A	PUHY-EP(300+300+350) YLM-A	PUHY-EP(300+300+300) YLM-A	PUHY-EP(300+350+400) YLM-A	PUHY-EP(350+350+400) YLM-A
Twinning joint			CMY-Y300VBK3					
Power supply	Tens./Freq./Phase	V/Hz/n ¹	3 phase 380-400-415 50Hz					
Cooling	Capacity ¹	kW	96.0	101.0	108.0	113.0	118.0	124.0
	Power input	kW	25.53	27.22	30.33	31.04	34.40	38.15
	EER		3.76	3.71	3.56	3.64	3.43	3.25
	SEER		6.05	5.82	5.73	5.76	5.67	5.58
	Temperature operating field	Indoor WB	°C	15.0-24.0				
Outdoor DB		°C	-5.0-52.0					
Heating	Capacity ²	kW	108.0	113.0	119.5	127.0	132.0	140.0
	Power input	kW	27.76	29.04	32.03	33.50	36.87	41.17
	COP		3.89	3.89	3.73	3.79	3.58	3.40
	SCOP		3.53	3.47	3.41	3.43	3.37	3.31
	Temperature operating field	Indoor WB	°C	15.0-27.0				
Outdoor DB		°C	-20.0-15.5					
Sound pressure level ³		dB(A)	65.5	66	66	66.5	66.5	66.5
Connectable indoor units	Total capacity		50 to 130% of O.U. capacity					
	Model/Quantity		P15-P250/2-50	P15-P250/2-50	P15-P250/2-50	P15-P250/2-50	P15-P250/3-50	P15-P250/3-50
Ø Ref. piping diameter	Liquid/Gas		19.05/41.28	19.05/41.28	19.05/41.28	19.05/41.28	19.05/41.28	19.05/41.28
External dimensions	(HxLxD)	mm	1710 x 920 x 740	1710 x 1220 x 740	1710 x 1220 x 740	1710 x 1220 x 740	1710 x 1220 x 740	1710 x 1220 x 740
			1710 x 1220 x 740	1710 x 1220 x 740	1710 x 1220 x 740	1710 x 1220 x 740	1710 x 1220 x 740	1710 x 1220 x 740
			1710 x 1220 x 740	1710 x 1220 x 740	1710 x 1220 x 740	1710 x 1750 x 740	1710 x 1750 x 740	1710 x 1750 x 740
Net weight		kg	686	729	723	792	786	780
Ref. Charge R410 ⁴ / CO ₂ Eq		kg/Tons	28.1 /58.67	30.9 /64.52	30.9 /64.52	32.4 /67.65	32.4 /67.65	32.4 /67.65

¹ Nominal cooling conditions: Indoor: 27°C DB / 19°C WB. Outdoor 35°C DB. Piping length 7.5 m, vertical difference 0 m.

² Nominal heating conditions: Indoor 20°C DB. Outdoor 7°C DB / 6°C WB. Piping length 7.5 m, vertical difference 0 m.

³ Values measured in anechoic chamber.

⁴ GWP value of HFC R410A 2088 according to 517 / 2014.

SCOP, SEER calculated according to Eurovent.

MODEL Triple			PUHY-EP1150YSLM-A1(-BS)	PUHY-EP1200YSLM-A1(-BS)	PUHY-EP1250YSLM-A1(-BS)	PUHY-EP1300YSLM-A1(-BS)	PUHY-EP1350YSLM-A1(-BS)
HP			46	48	50	52	54
Modules			PUHY-EP(350+350+450)YLM-A	PUHY-EP(350+400+450)YLM-A	PUHY-EP(350+450+450)YLM-A	PUHY-EP(400+450+450)YLM-A	PUHY-EP(400+450+450)YLM-A
Twinning joint			CMY-Y300VBK3				
Power supply	Tens./Freq./Phase	V/Hz/n°	3 phase 380-400-415 50Hz				
Cooling	Capacity ¹	kW	130.0	136.0	140.0	146.0	150
	Power input	kW	41.53	42.76	45.90	46.94	50.0
	EER		3.13	3.18	3.05	3.11	3.00
	SEER		5.54	5.57	5.53	5.56	5.52
	Temperature operating field	Indoor WB	°C	15.0-24.0			
Outdoor DB		°C	-5.0-52.0				
Heating	Capacity ²	kW	145.0	150.0	156.5	163.0	168.0
	Power input	kW	44.47	45.45	49.36	50.62	54.36
	COP		3.26	3.30	3.17	3.22	3.09
	SCOP		3.27	3.29	3.24	3.27	3.22
	Temperature operating field	Indoor WB	°C	15.0-27.0			
Outdoor DB		°C	-20.0-15.5				
Sound pressure level ³		dB(A)	66.5	67	67.5	68	68
Connectable indoor units	Total capacity		50 to 130% of O.U. capacity				
	Model/Quantity		P15-P250/3-50	P15-P250/3-50	P15-P250/3-50	P15-P250/3-50	P15-P250/3-50
Ø Ref. piping diameter	Liquid/Gas		19.05/41.28	19.05/41.28	19.05/41.28	19.05/41.2	19.05/41.28
External dimentions	(HxLxD)	mm	1710 x 1220 x 740	1710 x 1220 x 740	1710 x 1220 x 740	1710 x 1750 x 740	1710 x 1750 x 740
			1710 x 1220 x 740	1710 x 1750 x 740	1710 x 1750 x 740	1710 x 1750 x 740	1710 x 1750 x 740
			1710 x 1750 x 740	1710 x 1750 x 740	1710 x 1750 x 740	1710 x 1750 x 740	1710 x 1750 x 740
Net weight		kg	780	849	849	918	918
Ref. Charge R410 ⁴ /CO ₂ Eq		kg/Tons	32.4 /67.65	33.9 /70.78	33.9 /70.78	35.4 /73.91	35.4 /73.91

¹ Nominal cooling conditions: Indoor: 27°C DB / 19°C WB. Outdoor 35°C DB. Piping length 7.5 m, vertical difference 0 m.

² Nominal heating conditions: Indoor 20°C DB. Outdoor 7°C DB / 6°C WB. Piping length 7.5 m, vertical difference 0 m.

³ Values measured in anechoic chamber.

⁴ GWP value of HFC R410A 2088 according to 517 / 2014.

SCOP, SEER calculated according to Eurovent.

Y NEXT STAGE LINE

OUTDOOR UNITS - PUHY-(E)P Y(S)NW-A1(-BS)



NEW FOUR-SIDED BATTERY

STATIC PRESSURE OF FAN INCREASED UP TO 80 PA.

STATIC PRESSURE OF FAN INCREASED UP TO 80 PA.

CITY MULTI

NEW FAN WITH LOW FRICTION PROFILE

COMPRESSOR OPTIMISED WITH "MULTI-PORT" TECHNOLOGY

NEW AUTO-SHIFT MODE

NEW AUTO-SHIFT MODE PREHEAT DEFROST FUNCTION

ADVANCED ETC CONTROL OF EVAPORATION TEMPERATURE.

FLEXIBLE NOISE SETTING

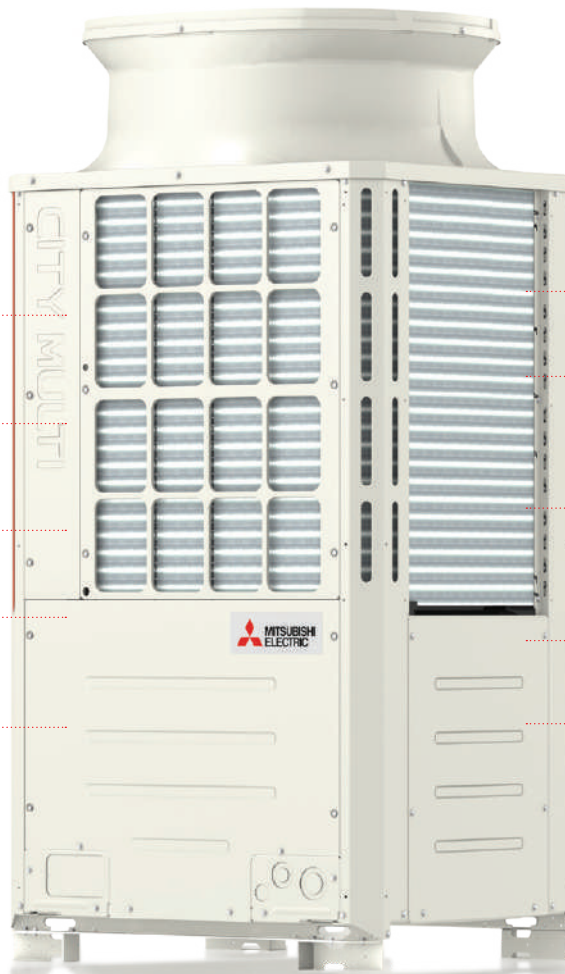

New design

The new outdoor units of the YNW series use a four-sided heat exchanger close to the top of the case near the fan. This technological and construction choice makes it possible to increase heat exchange efficiency.

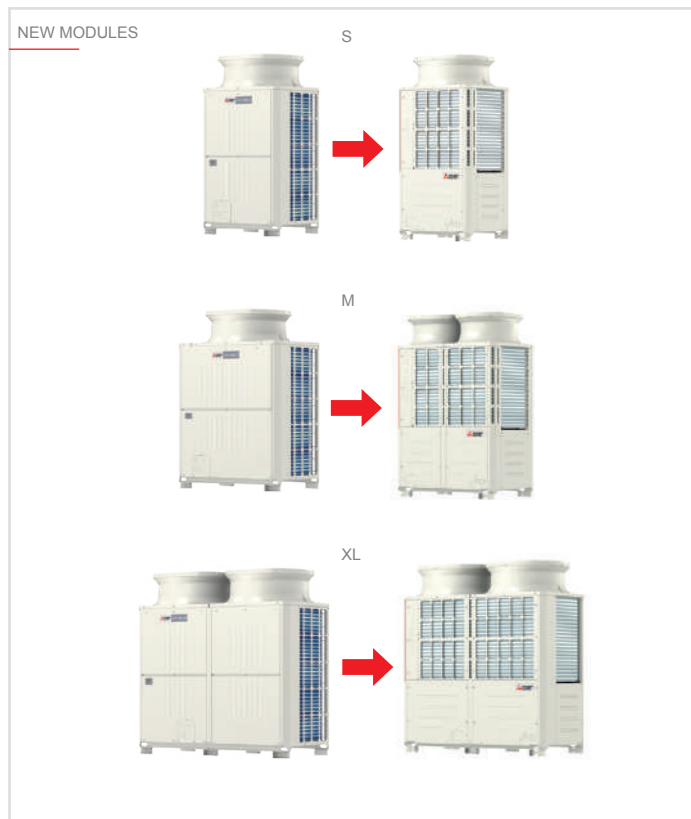
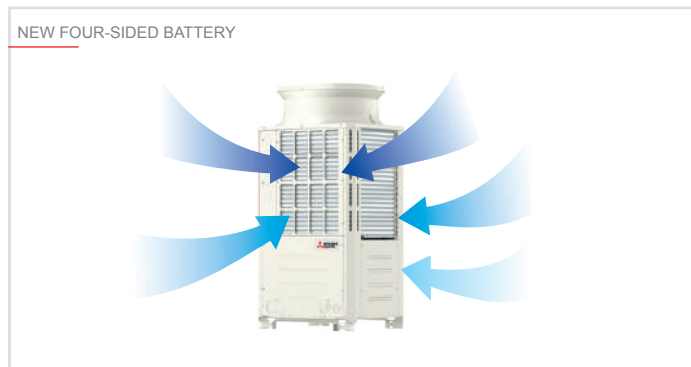

Single module

		Previous model	YNW
8HP	P200	S	S
10HP	P250	S	S
12HP	P300	L	S
14HP	P350	L	L
16HP	P400	L	L
18HP	P450	XL	L
20HP	P500	XL	XL

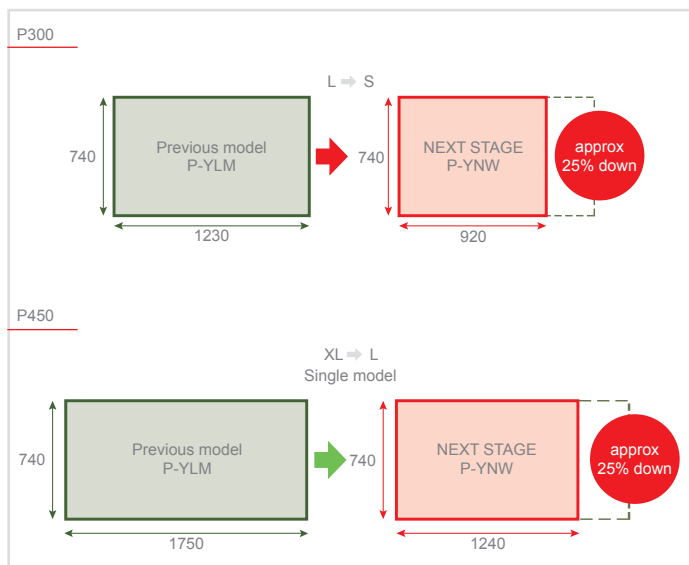

Energy saving

Energy efficiency has been further improved compared to YLM units and now hits top of the range performance values. SEER values have been raised by 139% (P500) compared to the previous model and SCOP values by 49% (P300 and P500). This allows the new YNW units to consume less energy in both cooling and heating. All year-round saving.



Advanced “Low Noise” function

“Low noise” mode can now be selected from five different settings: 85%, 70%, 60% and 50% (values referring to fan speed). Noise reduction is directly configurable from the control board of the outdoor unit. Different settings can be selected based on the installation requirements (in applications with special noise constraints).

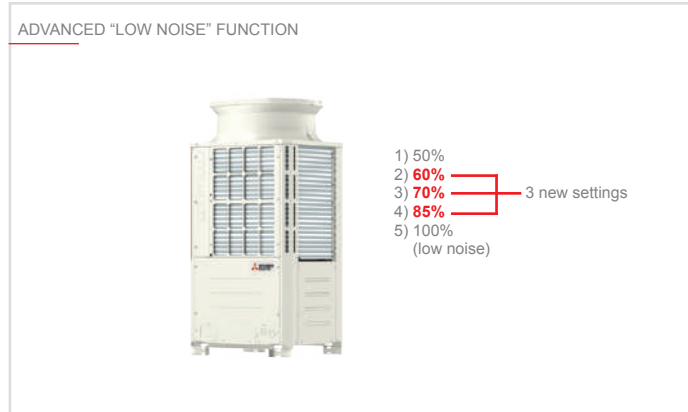

Fan blade profile

The YNW series fan has been completely redesigned to match the new four-sided battery. The profile of the fins has been optimised to minimise fluid flow losses.

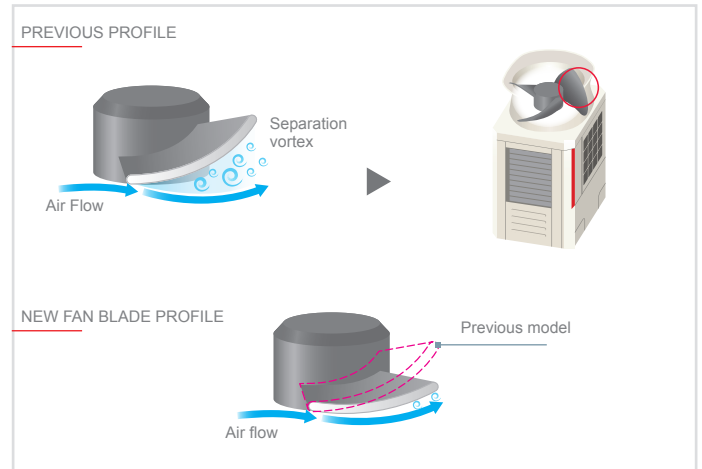

Key Technologies

--	--	--	--	--	--	--	--	--	--	--	--	--	--

Technical specifications

MODEL			PUHY-P200YNW-A1(-BS)	PUHY-P250YNW-A1(-BS)	PUHY-P300YNW-A1(-BS)	PUHY-P350YNW-A1(-BS)	PUHY-P400YNW-A1(-BS)
HP			8	10	12	14	16
Modules			PUHY-P200YNW-A1	PUHY-P250YNW-A1	PUHY-P300YNW-A1	PUHY-P350YNW-A1	PUHY-P400YNW-A1
Power supply	V/Hz/n°		3-phase 380-415V 50Hz				
Cooling	Capacity (nominal) **	kW	22.4	28.0	33.5	40.0	45.0
	Power input (nominal)	kW	4,81	7,14	8,79	10,95	14,19
	EER		4,65	3,92	3,81	3,65	3,17
	SEER		7,5	7,0	6,7	6,7	6,39
Temperature operating field	Indoor WB	°C	+15~+24	+15~+24	+15~+24	+15~+24	+15~+24
	Outdoor DB	°C	-5~+52	-5~+52	-5~+52	-5~+52	-5~+52
Heating	Capacity (nominal) **/ Capacity (max) **	kW	22,4/25,0	28,0/31,5	33,5/37,5	40,0/45,0	45,0/50,0
	Power input (nominal)/ Power input (max)	kW	4,35/5,10	6,02/7,20	7,11/8,46	8,65/10,39	10,46/12,37
	COP/COP max		5,14/4,90	4,65/4,37	4,71/4,43	4,62/4,33	4,30/4,04
	SCOP		4,39	4,21	4,16	4,24	4,13
Temperature operating field	Indoor WB	°C	+15~+27	+15~+27	+15~+27	+15~+27	+15~+27
	Outdoor DB	°C	-20~+15,5	-20~+15,5	-20~+15,5	-20~+15,5	-20~+15,5
Sound level **	Sound pressure (Sound power) level	dB(A)	58/59 (75/77)	60/61 (78/80)	61/64,5 (80/84)	62/64 (80/83)	65/67 (82/86)
Connectable indoor units	Total Capacity		50-130%	50-130%	50-130%	50-130%	50-130%
	Model/Quantity	CITY MULTI	P10-P250/1-20	P10-P250/1-25	P10-P250/1-30	P10-P250/1-35	P10-P250/1-40
Ø Ref. piping diameter	Liquid	mm	9,52	9,52	9,52	12,7	12,7
	Gas	mm	22,2	22,2	22,2	28,58	28,58
Fan	Type x quantity		Propeller fan x 1	Propeller fan x 1	Propeller fan x 1	Propeller fan x 2	Propeller fan x 2
	Air flow	m³/min	170	185	240	270	300
Compressor	Type		Inverter scroll hermetic				
	Motor output	kW	3,5	5,3	6,7	8,6	11,4
External dimensions	H(H*)xWxD	mm	1858(1798)x920x740	1858(1798)x920x740	1858(1798)x920x740	1858(1798)x1240x740	1858(1798)x1240x740
Net weight		kg	213	213	226	277	277
Refrigerant	Ref. Charge R410	kg	6,5	6,5	6,5	9,8	9,8
	CO ₂ eq. ^{**}	Tons	13,57	13,57	13,57	20,46	20,46

12*3 Nominal conditions:

Nominal heating conditions: Indoor 20°C DB. Outdoor 7°C DB / 6°C WB. Piping length 7.5 m, vertical difference 0 m.

Nominal cooling conditions: Indoor: 27°C DB / 19°C WB. Outdoor 35°C DB. Piping length 7.5 m, vertical difference 0 m

**2 Capacità nominale (registrata Eurovent - Conto Termico e Detrazioni)

**4 Values measured in anechoic chamber (Cooling mode/Heating mode)

**5 Without legs

**6 GWP value of HFC R410A2088 according to 517 / 2014

The SEER and SCOP data are based on the EN14825 measurement standard

Technical specifications

MODEL				PUHY-P450YNW-A1(-BS)	PUHY-P500YNW-A1(-BS)	PUHY-P400YSNW-A1(-BS)	PUHY-P450YSNW-A1(-BS)	PUHY-P500YSNW-A1(-BS)
HP				18	20	16	18	20
Modules				PUHY-P450YNW-A1	PUHY-P500YNW-A1	PUHY-P(200+200)YNW-A1	PUHY-P(200+250)YNW-A1	PUHY-P(250+250)YNW-A1
Power supply	V/Hz/n°			3-phase 380-415V 50Hz				
Cooling	Capacity (nominal) *1	kW		50,0	56,0	45,0	50,0	56,0
	Power input (nominal)	kW		14,57	17,55	9,97	12,16	14,73
	EER			3,43	3,19	4,51	4,11	3,80
	SEER			6,48	6,32	7,42	7,19	7,02
	Temperature operating field	Indoor WB	°C	+15~+24	+15~+24	+15~+24	+15~+24	+15~+24
	Outdoor DB	°C	-5~+52	-5~+52	-5~+52	-5~+52	-5~+52	
Heating	Capacity (nominal) *2/ Capacity (max) *3	kW		50,0/56,0	56,0/63,0	45,0/50,0	50,0/56,0	56,0/63,0
	Power input (nominal)/ Power input (max)	kW		11,68/14,00	13,42/15,98	9,03/10,52	10,59/12,55	12,41/14,89
	COP/COP max			4,28/4,00	4,17/3,94	4,98/4,75	4,72/4,46	4,51/4,23
	SCOP			4,00	3,91	4,27	4,16	4,08
	Temperature operating field	Indoor WB	°C	+15~+27	+15~+27	+15~+27	+15~+27	+15~+27
	Outdoor DB	°C	-20~+15,5	-20~+15,5	-20~+15,5	-20~+15,5	-20~+15,5	
Sound level *4	Sound pressure (Sound power) level	dB(A)		65,5/69,5 (84/89)	63,5/66,5 (82/85)	61/62 (78/80)	62/63 (80/82)	63/64 (81/83)
Connectable indoor units	Total Capacity			50-130%	50-130%	50-130%	50-130%	50-130%
	Model/Quantity	CITY MULTI		P10-P250/1-45	P10-P250/1-50	P10-P250/1-40	P10-P250/1-45	P10-P250/1-50
Ø Ref. piping diameter	Liquid	mm		15,88	15,88	12,7	15,88	15,88
	Gas	mm		28,58	28,58	28,58	28,58	28,58
Fan	Type x quantity			Propeller fan x 2	Propeller fan x 2	Propeller fan x 2	Propeller fan x 2	Propeller fan x 2
	Air flow	m³/min		305	365	170+170	170+185	185+185
Compressor	Type			Inverter scroll hermetic				
	Motor output	kW		11,7	13,3	3,5+3,5	3,5+5,3	5,3+5,3
External dimensions	H(H*)xWxD	mm		1858(1798)x1240x740	1858(1798)x1750x740	1858(1798)x920x740 1858(1798)x920x740	1858(1798)x920x740 1858(1798)x920x740	1858(1798)x920x740 1858(1798)x920x740
Net weight		kg		293	334	213+213	213+213	213+213
Refrigerant	Ref. Charge R410	kg		10,8	10,8	13	13	13
	CO ₂ eq.*5	Tons		22,55	22,55	27,14	27,14	27,14

Technical specifications

MODEL				PUHY-P550YSNW-A1(-BS)	PUHY-P600YSNW-A1(-BS)	PUHY-P650YSNW-A1(-BS)	PUHY-P700YSNW-A1(-BS)	PUHY-P750YSNW-A1(-BS)
HP				22	24	26	28	30
Modules				PUHY-P(250+300)YNW-A1	PUHY-P(300+300)YNW-A1	PUHY-P(250+400)YNW-A1	PUHY-P(350+350)YNW-A1	PUHY-P(350+400)YNW-A1
Power supply	V/Hz/n°			3-phase 380-415V 50Hz				
Cooling	Capacity (nominal) *1	kW		63,0	69,0	73,0	80,0	85,0
	Power input (nominal)	kW		16,84	18,69	21,79	22,59	25,83
	EER			3,74	3,69	3,35	3,54	3,29
	SEER			6,76	6,57	6,50	6,63	6,46
	Temperature operating field	Indoor WB	°C	+15~+24	+15~+24	+15~+24	+15~+24	+15~+24
	Outdoor DB	°C	-5~+52	-5~+52	-5~+52	-5~+52	-5~+52	
Heating	Capacity (nominal) *2/ Capacity (max) *3	kW		63,0/69,0	69,0/76,5	73,0/81,5	80,0/88,0	85,0/95,0
	Power input (nominal)/ Power input (max)	kW		13,87/16,15	15,13/17,83	16,97/20,17	17,85/20,95	19,72/23,45
	COP/COP max			4,54/4,27	4,56/4,29	4,30/4,04	4,48/4,20	4,31/4,05
	SCOP			4,06	4,03	4,04	4,10	4,05
	Temperature operating field	Indoor WB	°C	+15~+27	+15~+27	+15~+27	+15~+27	+15~+27
	Outdoor DB	°C	-20~+15,5	-20~+15,5	-20~+15,5	-20~+15,5	-20~+15,5	
Sound level *4	Sound pressure (Sound power) level	dB(A)		63,5/66 (82/85)	64/67,5 (83/87)	66,5/68 (83/87)	65/67 (83/86)	67/68,5 (84/88)
Connectable indoor units	Total Capacity			50-130%	50-130%	50-130%	50-130%	50-130%
	Model/Quantity	CITY MULTI		P10-P250/2-50	P10-P250/2-50	P10-P250/2-50	P10-P250/2-50	P10-P250/2-50
Ø Ref. piping diameter	Liquid	mm		15,88	15,88	15,88	19,05	19,05
	Gas	mm		28,58	28,58	28,58	34,93	34,93
Fan	Type x quantity			Propeller fan x 2	Propeller fan x 2	Propeller fan x 3	Propeller fan x 4	Propeller fan x 4
	Air flow	m³/min		185+240	240+240	185+300	270+270	270+300
Compressor	Type			Inverter scroll hermetic				
	Motor output	kW		5,3+6,7	6,7 + 6,7	5,3 + 11,4	8,6+8,6	8,6+11,4
External dimensions	H(H*)xWxD	mm		1858(1798)x920x740 1858(1798)x920x740	1858(1798)x920x740 1858(1798)x920x740	1858(1798)x920x740 1858(1798)x1240x740	1858(1798)x1240x740 1858(1798)x1240x740	1858(1798)x1240x740 1858(1798)x1240x740
Net weight		kg		213+226	226+226	213+277	277+277	277+277
Refrigerant	Ref. Charge R410	kg		13	13	16,3	19,6	19,6
	CO ₂ eq.*5	Tons		27,14	27,14	34,03	40,92	40,92

*1*2*3 Nominal conditions:

Nominal heating conditions: Indoor 20°C DB. Outdoor 7°C DB / 6°C WB. Piping length 7.5 m, vertical difference 0 m.

Nominal cooling conditions: Indoor: 27°C DB / 19°C WB. Outdoor 35°C DB. Piping length 7.5 m, vertical difference 0 m

*2 Capacità nominale (registrata Eurovent - Conto Termico e Detrazioni)

*4 Values measured in anechoic chamber (Cooling mode/Heating mode)

*5 Without legs

*6 GWP value of HFC R410A 2008 according to 517 / 2014

The SEER and SCOP data are based on the EN14825 measurement standard

Technical specifications

MODEL			PUHY-P800YSNW-A1(-BS)	PUHY-P850YSNW-A1(-BS)	PUHY-P900YSNW-A1(-BS)	PUHY-P950YSNW-A1(-BS)	PUHY-P1000YSNW-A1(-BS)
HP			32	34	36	38	40
Modules			PUHY-P(350+450)YNW-A1	PUHY-P(400+450)YNW-A1	PUHY-P(450+450)YNW-A1	PUHY-P (250+350+350)YNW-A1	PUHY-P (250+350+400)YNW-A1
Power supply	V/Hz/n°		3-phase 380-415V 50Hz				
Cooling	Capacity (nominal) *1	kW	90	96,0	101,0	108,0	113,0
	Power input (nominal)	kW	26,31	30,0	30,42	30,0	33,13
	EER		3,42	3,20	3,32	3,60	3,41
	SEER		6,48	6,38	6,41	6,72	6,59
	Temperature operating field	Indoor WB °C	+15~+24	+15~+24	+15~+24	+15~+24	+15~+24
	Outdoor DB °C	-5~+52	-5~+52	-5~+52	-5~+52	-5~+52	
Heating	Capacity (nominal) *2/ Capacity (max) *4	kW	90,0/100,0	96,0/108,0	101,0/113,0	108,0/119,5	113,0/127,0
	Power input (nominal)/ Power input (max)	kW	20,97/24,87	23,07/27,76	24,33/29,12	24,10/28,38	25,91/31,05
	COP/COP max		4,29/4,02	4,16/3,89	4,15/3,88	4,48/4,21	4,36/4,09
	SCOP		3,88	3,86	3,71	4,09	4,06
	Temperature operating field	Indoor WB °C	+15~+27	+15~+27	+15~+27	+15~+27	+15~+27
	Outdoor DB °C	-20~+15,5	-20~+15,5	-20~+15,5	-20~+15,5	-20~+15,5	
Sound level **	Sound pression (Sound power) level	dB(A)	67,5/71 (85/90)	68,5/71,5 (86/91)	68,5/72,5 (87/92)	66/68 (84/87)	68/69,5 (85/88)
Connectable indoor units	Total Capacity		50-130%	50-130%	50-130%	50-130%	50-130%
	Model/Quantity	CITY MULTI	P10-P250/2-50	P10-P250/2-50	P10-P250/2-50	P10-P250/2-50	P10-P250/2-50
Ø Ref. piping diameter	Liquid	mm	19,05	19,05	19,05	19,05	19,05
	Gas	mm	34,93	41,28	41,28	41,28	41,28
Fan	Type x quantity		Propeller fan x 4	Propeller fan x 4	Propeller fan x 4	Propeller fan x 5	Propeller fan x 5
	Air flow	m³/min	270+305	300+305	305+305	185+270+270	185+270+300
Compressor	Type		Inverter scroll hermetic				
	Motor output	kW	8,6+11,7	11,4+11,7	11,7+11,7	5,3+8,6+8,6	5,3+8,6+11,4
External dimentions	H(H*)xWxD	mm	1858(1798)x1240x740 1858(1798)x1240x740	1858(1798)x1240x740 1858(1798)x1240x740	1858(1798)x1240x740 1858(1798)x1240x740	1858(1798)x920x740 1858(1798)x1240x740 1858(1798)x1240x740	1858(1798)x920x740 1858(1798)x1240x740 1858(1798)x1240x740
	Net weight	kg	277+293	277+293	293+293	213+277+277	213+277+277
Refrigerant	Ref. Charge R410	kg	20,6	20,6	21,6	26,1	26,1
	CO ₂ eq.*5	Tons	43,01	43,01	45,10	54,49	54,49

Technical specifications

MODEL			PUHY-P1050YSNW-A1(-BS)	PUHY-P1100YSNW-A1(-BS)	PUHY-P1150YSNW-A1(-BS)	PUHY-P1200YSNW-A1(-BS)	PUHY-P1250YSNW-A1(-BS)
HP			42	44	46	48	50
Modules			PUHY-P (250+400+400)YNW-A1	PUHY-P (350+350+400)YNW-A1	PUHY-P (350+400+400)YNW-A1	PUHY-P (400+400+400)YNW-A1	PUHY-P (400+400+450)YNW-A1
Power supply	V/Hz/n°		3-phase 380-415V 50Hz				
Cooling	Capacity (nominal) *1	kW	118,0	124,0	130,0	136,0	140,0
	Power input (nominal)	kW	36,41	36,79	40,49	44,29	44,30
	EER		3,24	3,37	3,21	3,07	3,16
	SEER		6,47	6,49	6,38	6,29	6,30
	Temperature operating field	Indoor WB °C	+15~+24	+15~+24	+15~+24	+15~+24	+15~+24
	Outdoor DB °C	-5~+52	-5~+52	-5~+52	-5~+52	-5~+52	
Heating	Capacity (nominal) *2/ Capacity (max) *3	kW	118,0/132,0	124,0/140,0	130,0/145,0	136,0/150,0	140,0/156,5
	Power input (nominal)/ Power input (max)	kW	27,76/33,08	28,44/34,22	30,51/36,25	32,61/38,36	33,65/40,12
	COP/COP max		4,25/3,99	4,36/4,09	4,26/4,00	4,17/3,91	4,16/3,90
	SCOP		4,05	4,07	4,03	4,03	3,91
	Temperature operating field	Indoor WB °C	+15~+27	+15~+27	+15~+27	+15~+27	+15~+27
	Outdoor DB °C	-20~+15,5	-20~+15,5	-20~+15,5	-20~+15,5	-20~+15,5	
Sound level **	Sound pression (Sound power) level	dB(A)	68,5/70,5 (86/90)	68,5/70 (86/89)	69/71 (86/90)	70/72 (87/91)	70/73 (88/92)
Connectable indoor units	Total Capacity		50-130%	50-130%	50-130%	50-130%	50-130%
	Model/Quantity	CITY MULTI	P10-P250/3-50	P10-P250/3-50	P10-P250/3-50	P10-P250/3-50	P10-P250/3-50
Ø Ref. piping diameter	Liquid	mm	19,05	19,05	19,05	19,05	19,05
	Gas	mm	41,28	41,28	41,28	41,28	41,28
Fan	Type x quantity		Propeller fan x 5	Propeller fan x 6	Propeller fan x 6	Propeller fan x 6	Propeller fan x 6
	Air flow	m³/min	185+300+300	270+270+300	270+300+300	300+300+300	300+300+305
Compressor	Type		Inverter scroll hermetic				
	Motor output	kW	5,3+11,4+11,4	8,6+8,6+11,4	8,6+11,4+11,4	11,4+11,4+11,4	11,4+11,4+11,7
External dimentions	H(H*)xWxD	mm	1858(1798)x920x740 1858(1798)x1240x740 1858(1798)x1240x740	1858(1798)x1240x740 1858(1798)x1240x740 1858(1798)x1240x740	1858(1798)x1240x740 1858(1798)x1240x740 1858(1798)x1240x740	1858(1798)x1240x740 1858(1798)x1240x740 1858(1798)x1240x740	1858(1798)x1240x740 1858(1798)x1240x740 1858(1798)x1240x740
	Net weight	kg	213+277+277	277+277+277	277+277+277	277+277+277	277+277+293
Refrigerant	Ref. Charge R410	kg	26,1	29,4	29,4	29,4	30,4
	CO ₂ eq.*5	Tons	54,49	61,38	61,38	61,38	63,47

*1~*3 Nominal conditions:

Nominal heating conditions: Indoor 20°C DB. Outdoor 7°C DB / 6°C WB. Piping length 7.5 m, vertical difference 0 m.

Nominal cooling conditions: Indoor: 27°C DB / 19°C WB. Outdoor 35°C DB. Piping length 7.5 m, vertical difference 0 m

*4 Capacità nominale (registrata Eurovent - Conto Termico e Detrazioni)

*5 Values measured in anechoic chamber (Cooling mode/Heating mode)

** Without legs

** GWP value of HFC R410A2088 according to 517 / 2014

The SEER and SCOP data are based on the EN14825 measurement standard

Technical specifications

MODEL			PUHY-P1300YSNW-A1(-BS)		PUHY-P1350YSNW-A1(-BS)	
HP			52		54	
Modules			PUHY-P (400+450+450)YNW-A1		PUHY-P (450+450+450)YNW-A1	
Power supply	V/Hz/n°		3-fase 380-415V 50Hz			
Cooling	Capacity (nominal) *1	kW	146,0		150,0	
	Power input (nominal)	kW	45,06		45,18	
	EER		3,24		3,32	
	SEER		6,32		6,34	
	Temperature operating field	Indoor WB °C	+15~+24		+15~+24	
	Outdoor DB °C	-5~+52		-5~+52		
Heating	Capacity (nominal) *2/ Capacity (max) *3	kW	146,0/163,0		150,0/168,0	
	Power input (nominal)/ Power input (max)	kW	35,18/41,90		36,14/43,29	
	COP/COP max		4,15/3,89		4,15/3,88	
	SCOP		3,81		3,71	
	Temperature operating field	Indoor WB °C	+15~+27		+15~+27	
	Outdoor DB °C	-20~+15,5		-20~+15,5		
Sound level *4	Sound pression (Sound power) level	dB(A)	70/73,5 (88/93)		70,5/74,5 (89/94)	
Connectable indoor units	Total Capacity		50-130%		50-130%	
	Model/Quantity	CITY MULTI	P10-P250/3-50		P15-P250/1-39	
Ø Ref. piping diameter	Liquid	mm	19,05		15,88	
	Gas	mm	41,28		28,58	
Fan	Type x quantity		Propeller fan x 6		Propeller fan x 6	
	Air flow	m³/min	300+305+305		305+305+305	
Compressor	Type		Inverter scroll hermetic			
	Motor output	kW	11,4+11,7+11,7		11,7+11,7+11,7	
External dimentions	H(H*5)xWxD	mm	1858(1798)x1240x740 1858(1798)x1240x740 1858(1798)x1240x740		1858(1798)x1240x740 1858(1798)x1240x740 1858(1798)x1240x740	
	Net weight	kg	277+293+293		293+293+293	
	Refrigerant	Ref. Charge R410	kg	31,14		32,4
CO ₂ eq.*5		Tons	65,56		67,65	

Technical specifications

MODEL			PUHY-EP200YNW-A1 (-BS)	PUHY-EP250YNW-A1 (-BS)	PUHY-EP300YNW-A1 (-BS)	PUHY-EP350YNW-A1 (-BS)	PUHY-EP400YNW-A1 (-BS)
HP			8	10	12	14	16
Modules			PUHY-EP200YNW-A1	PUHY-EP250YNW-A1	PUHY-EP300YNW-A1	PUHY-EP350YNW-A1	PUHY-EP400YNW-A1
Power supply	V/Hz/n°		3-phase 4-wire 380-400-415 V 50/60 Hz				
Cooling	Capacity (nominal) *1	kW	22.4	28.0	33.5	40.0	45.0
	Power input (nominal)	kW	4.47	6.55	7.73	9.97	12.39
	EER		5.01	4.27	4.33	4.01	3.63
	SEER		7.76	7.51	7.26	7.03	7.02
	Temperature operating field	Indoor WB °C	+15~+24	+15~+24	+15~+24	+15~+24	+15~+24
	Outdoor DB °C	-5~+52	-5~+52	-5~+52	-5~+52	-5~+52	
Heating	Capacity (nominal) *2/ Capacity (max) *3	kW	22.4 / 25.0	28.0 / 31.5	33.5 / 37.5	40.0 / 45.0	45.0 / 50.0
	Power input (nominal)/ Power input (max)	kW	4.29 / 4.97	5.89 / 7.00	6.76 / 8.06	8.28 / 9.91	10.02 / 11.90
	COP/COP max		5.22 / 5.03	4.75 / 4.50	4.95 / 4.65	4.83 / 4.54	4.49 / 4.20
	SCOP		4.45	4.31	4.22	4.40	4.28
	Temperature operating field	Indoor WB °C	+15~+27	+15~+27	+15~+27	+15~+27	+15~+27
	Outdoor DB °C	-20~+15,5	-20~+15,5	-20~+15,5	-20~+15,5	-20~+15,5	
Sound level *4	Sound pression (Sound power) level	dB(A)	58.0/59.0 (75/78)	60.0/61.0 (78/80)	61.0/64.5 (80/84)	62.0/63.5 (80/83)	65.0/65.5 (82/84)
Connectable indoor units	Total Capacity		50-130%	50-130%	50-130%	50-130%	50-130%
	Model/Quantity	CITY MULTI	P10-P250/1-20	P10-P250/1-25	P10-P250/1-30	P10-P250/1-35	P10-P250/1-40
Ø Ref. piping diameter	Liquid	mm	9.52	9.52	9.52	12.7	12.7
	Gas	mm	22.2	22.2	28.58	28.58	28.58
Fan	Type x quantity		Propeller fan x 1	Propeller fan x 1	Propeller fan x 1	Propeller fan x 2	Propeller fan x 2
	Air flow	m³/min	170	185	240	270	270
Compressor	Type		Inverter scroll hermetic compressor				
	Motor output	kW	3.4	5.1	6.1	7.7	9.8
External dimentions	H(H*5)xWxD	mm	1858(1798)x920x740	1858(1798)x920x740	1858(1798)x920x740	1858(1798)x1240x740	1858(1798)x1240x740
	Net weight	kg	228	228	231	282	303
	Refrigerant	Ref. Charge R410	kg	6,5	6,5	6,5	9,8
CO ₂ eq.*5		Tons	13,57	13,57	13,57	20,46	22,55

*1*2*3 Nominal conditions:

Nominal heating conditions: Indoor 20°C DB. Outdoor 7°C DB / 6°C WB. Piping length 7.5 m, vertical difference 0 m.

Nominal cooling conditions: Indoor: 27°C DB / 19°C WB. Outdoor 35°C DB. Piping length 7.5 m, vertical difference 0 m

*2 Capacità nominale (registrata Eurovent - Conto Termico e Detrazioni)

*4 Values measured in anechoic chamber (Cooling mode/Heating mode)

*5 Without legs

*6 GWP value of HFC R410A 2008 according to 517 / 2014

The SEER and SCOP data are based on the EN14825 measurement standard

Technical specifications

MODEL			PUHY-EP450YNW-A1 (-BS)	PUHY-EP500YNW-A1 (-BS)	PUHY-EP400YSNW-A1 (-BS)	PUHY-EP450YSNW-A1 (-BS)	PUHY-EP500YSNW-A1 (-BS)
HP			18	20	16	18	20
Modules			PUHY-EP450YNW-A1	PUHY-EP500YNW-A1	PUHY-EP(200+200)YNW-A1	PUHY-EP(200+250)YNW-A1	PUHY-EP(250+250)YNW-A1
Power supply	V/Hz/n°		3-phase 4-wire 380-400-415 V 50/60 Hz				
Cooling	Capacity (nominal) *1	kW	50.0	56.0	45.0	50.0	56.0
	Power input (nominal)	kW	13.85	16.56	9.27	11.21	13.52
	EER		3.61	3.38	4.85	4.46	4.14
	SEER		7.07	6.55	7.90	7.70	7.57
	Temperature operating field	Indoor WB	°C	+15~+24	+15~+24	+15~+24	+15~+24
Outdoor DB		°C	-5~+52	-5~+52	-5~+52	-5~+52	-5~+52
Heating	Capacity (nominal) *2/ Capacity (max) *4	kW	50.0 / 56.0	56.0 / 63.0	45.0 / 50.0	50.0 / 56.0	56.0 /
	Power input (nominal)/ Power input (max)	kW	11.38 / 13.65	13.36 / 15.94	8.89 / 10.26	10.39 / 12.20	12.17 /
	COP/COP max		4.39 / 4.10	4.19 / 3.95	5.06 / 4.87	4.81 / 4.59	4.60 /
	SCOP		4.17	4.02	4.33	4.24	4.18
	Temperature operating field	Indoor WB	°C	+15~+27	+15~+27	+15~+27	+15~+27
Outdoor DB		°C	-20~+15.5	-20~+15.5	-20~+15.5	-20~+15.5	-20~+15.5
Sound level **	Sound pression (Sound power) level	dB(A)	65.5/69.5 (84/88)	63.5/66.5 (82/85)	61.0/62.0 (78/81)	62.0/63.0 (80/82)	63.0/64.0 (81/83)
Connectable indoor units	Total Capacity		50-130%	50-130%	50-130%	50-130%	50-130%
	Model/Quantity	CITY MULTI	P10-P250/1-45	P10-P250/1-50	P10-P250/1-40	P10-P250/1-45	P10-P250/1-50
Ø Ref. piping diameter	Liquid	mm	15.88	15.88	12.7	15.88	15.88
	Gas	mm	28.58	28.58	28.58	28.58	28.58
Fan	Type x quantity		Propeller fan x 2	Propeller fan x 2	Propeller fan x 2	Propeller fan x 2	Propeller fan x 2
	Air flow	m³/min	305	365	170 + 170	170 + 185	185 + 185
Compressor	Type		Inverter scroll hermetic compressor				
	Motor output	kW	11.1	12.5	3.4 + 3.4	5.1 + 3.4	5.1 + 5.1
External dimenstions	H(H*5)xWxD	mm	1858(1798)x1240x740	1858(1798)x1750x740	1858(1798)x920x740 1858(1798)x920x740	1858(1798)x920x740 1858(1798)x920x740	1858(1798)x920x740 1858(1798)x920x740
Net weight		kg	303	342	228 + 228	228 + 228	228 + 228
Refrigerant	Ref. Charge R410	kg	10,8	10,8	13	13	13
	CO ₂ eq.**5	Tons	22,55	22,55	27,14	27,14	27,14

Technical specifications

MODEL			PUHY-EP550YSNW-A1 (-BS)	PUHY-EP600YSNW-A1 (-BS)	PUHY-EP650YSNW-A1 (-BS)	PUHY-EP700YSNW-A1 (-BS)	PUHY-EP750YSNW-A1 (-BS)
HP			22	24	26	28	30
Modules			PUHY-EP(250+300)YNW-A1	PUHY-EP(300+300)YNW-A1	PUHY-EP(250+400)YNW-A1	PUHY-EP(350+350)YNW-A1	PUHY-EP(350+400)YNW-A1
Power supply	V/Hz/n°		3-phase 4-wire 380-400-415 V 50/60 Hz				
Cooling	Capacity (nominal) *1	kW	63.0	69.0	73.0	80.0	85.0
	Power input (nominal)	kW	15.10	16.42	19.46	20.61	23.03
	EER		4.17	4.20	3.75	3.88	3.69
	SEER		7.38	7.24	7.06	6.92	6.91
	Temperature operating field	Indoor WB	°C	+15~+24	+15~+24	+15~+24	+15~+24
Outdoor DB		°C	-5~+52	-5~+52	-5~+52	-5~+52	-5~+52
Heating	Capacity (nominal) *2/ Capacity (max) *3	kW	63.0 / 69.0	69.0 / 76.5	73.0 / 81.5	80.0 / 88.0	85.0 / 95.0
	Power input (nominal)/ Power input (max)	kW	13.37 / 15.54	14.37 / 16.96	16.40 / 19.49	17.09 / 20.00	18.88 / 22.51
	COP/COP max		4.71 / 4.44	4.80 / 4.51	4.45 / 4.18	4.68 / 4.40	4.50 / 4.22
	SCOP		4.14	4.10	4.16	4.26	4.20
	Temperature operating field	Indoor WB	°C	+15~+27	+15~+27	+15~+27	+15~+27
Outdoor DB		°C	-20~+15.5	-20~+15.5	-20~+15.5	-20~+15.5	-20~+15.5
Sound level **	Sound pression (Sound power) level	dB(A)	63.5/66.0 (82/85)	64.0/67.5 (83/87)	66.5/67.0 (83/85)	65.0/66.5 (83/86)	67.0/67.5 (84/87)
Connectable indoor units	Total Capacity		50-130%	50-130%	50-130%	50-130%	50-130%
	Model/Quantity	CITY MULTI	P10-P250/2-50	P10-P250/2-50	P10-P250/2-50	P10-P250/2-50	P10-P250/2-50
Ø Ref. piping diameter	Liquid	mm	15.88	15.88	15.88	19.05	19.05
	Gas	mm	28.58	28.58	28.58	34.93	34.93
Fan	Type x quantity		Propeller fan x 2	Propeller fan x 2	Propeller fan x 3	Propeller fan x 4	Propeller fan x 4
	Air flow	m³/min	185 + 240	240 + 240	185 + 270	270 + 270	270 + 270
Compressor	Type		Inverter scroll hermetic compressor				
	Motor output	kW	5.1 + 6.1	6.1 + 6.1	5.1 + 9.8	7.7 + 7.7	7.7 + 9.8
External dimenstions	H(H*5)xWxD	mm	1858(1798)x920x740 1858(1798)x920x740	1858(1798)x920x740 1858(1798)x920x740	1858(1798)x920x740 1858(1798)x1240x740	1858(1798)x1240x740 1858(1798)x1240x740	1858(1798)x1240x740 1858(1798)x1240x740
Net weight		kg	228 + 231	231 + 231	228 + 303	282 + 282	282 + 303
Refrigerant	Ref. Charge R410	kg	13	13	17,3	19,6	20,6
	CO ₂ eq.**5	Tons	27,14	27,14	36,12	40,92	43,01

*1~*3 Nominal Conditions:

Cooling conditions: Indoor: 27°C DB / 19°C WB. Outdoor 35°C DB. Piping length 7.5 m, vertical difference 0 m.

Heating conditions: Indoor 20°C DB. Outdoor 7°C DB / 6°C WB. Piping length 7.5 m, vertical difference 0 m.

** Eurovent registered

** Values measured in anechoic chamber (Cooling mode/Heating mode)

**5 without legs

**6 GWP value of HFC R410A 2088 according to 517 / 2014.

The SEER and SCOP data are based on the EN14825 measurement standard

Technical specifications

MODEL			PUHY-EP800YSNW-A1 (-BS)	PUHY-EP850YSNW-A1 (-BS)	PUHY-EP900YSNW-A1 (-BS)	PUHY-EP950YSNW-A1 (-BS)	PUHY-EP1000YSNW-A1 (-BS)
HP			32	34	36	38	40
Modules			PUHY-EP(350+450)YNW-A1	PUHY-EP(400+450)YNW-A1	PUHY-EP(450+450)YNW-A1	PUHY-EP(250+350+350)YNW-A1	PUHY-EP(250+350+400)YNW-A1
Power supply	V/Hz/n°		3-phase 4-wire 380-400-415 V 50/60 Hz				
Cooling	Capacity (nominal) *1	kW	90.0	96.0	101.0	108.0	113.0
	Power input (nominal)	kW	24.52	27.35	28.85	27.34	29.73
	EER		3.67	3.51	3.50	3.95	3.80
	SEER		6.94	6.97	6.99	7.09	7.06
	Temperature operating field	Indoor WB °C	+15~+24	+15~+24	+15~+24	+15~+24	+15~+24
	Outdoor DB °C	-5~+52	-5~+52	-5~+52	-5~+52	-5~+52	
Heating	Capacity (nominal) *2/ Capacity (max) *3	kW	90.0 / 100.0	96.0 / 108.0	101.0 / 113.0	108.0 / 119.5	113.0 / 127.0
	Power input (nominal)/ Power input (max)	kW	20.27 / 24.03	22.32 / 26.86	23.76 / 28.46	23.17 / 27.22	24.94 / 29.81
	COP/COP max		4.44 / 4.16	4.30 / 4.02	4.25 / 3.97	4.66 / 4.39	4.53 / 4.26
	SCOP		4.21	4.16	4.15	4.24	4.20
	Temperature operating field	Indoor WB °C	+15~+27	+15~+27	+15~+27	+15~+27	+15~+27
	Outdoor DB °C	-20~+15.5	-20~+15.5	-20~+15.5	-20~+15.5	-20~+15.5	
Sound level *4	Sound pression (Sound power) level	dB(A)	67.5/70.5 (85/89)	68.5/71.0 (86/89)	68.5/72.5 (87/91)	66.0/67.5 (84/87)	68.0/68.5 (85/87)
Connectable indoor units	Total Capacity		50-130%	50-130%	50-130%	50-130%	50-130%
	Model/Quantity	CITY MULTI	P10-P250/2-50	P10-P250/2-50	P10-P250/2-50	P10-P250/2-50	P10-P250/2-50
Ø Ref. piping diameter	Liquid	mm	19.05	19.05	19.05	19.05	19.05
	Gas	mm	34.93	41.28	41.28	41.28	41.28
Fan	Type x quantity		Propeller fan x 4	Propeller fan x 4	Propeller fan x 4	Propeller fan x 5	Propeller fan x 5
	Air flow	m³/min	270 + 305	270 + 305	305 + 305	185 + 270 + 270	185 + 270 + 270
Compressor	Type		Inverter scroll hermetic compressor				
	Motor output	kW	7.7 + 11.1	9.8 + 11.1	11.1 + 11.1	5.1 + 7.7 + 7.7	5.1 + 7.7 + 7.7
External dimentions	H(H*5)xWxD	mm	1858(1798)x1240x740 1858(1798)x1240x740	1858(1798)x1240x740 1858(1798)x1240x740	1858(1798)x1240x740 1858(1798)x1240x740	1858(1798)x920x740 1858(1798)x920x740 1858(1798)x920x740	1858(1798)x920x740 1858(1798)x1240x740 1858(1798)x1240x740
	Net weight	kg	282 + 303	303 + 303	303 + 303	282 + 282 + 282	228 + 228 + 303
Refrigerant	Ref. Charge R410	kg	20,6	21,6	21,6	26,1	27,1
	CO ₂ eq.*5	Tons	43,01	45,1	45,1	54,49	56,58

Technical specifications

MODEL			PUHY-EP1050YSNW-A1 (-BS)	PUHY-EP1100YSNW-A1 (-BS)	PUHY-EP1150YSNW-A1 (-BS)	PUHY-EP1200YSNW-A1 (-BS)	PUHY-EP1250YSNW-A1 (-BS)
HP			42	44	46	48	50
Modules			PUHY-EP(250+400+400)YNW-A1	PUHY-EP(350+350+400)YNW-A1	PUHY-EP(350+400+400)YNW-A1	PUHY-EP(400+400+400)YNW-A1	PUHY-EP(400+400+450)YNW-A1
Power supply	V/Hz/n°		3-phase 4-wire 380-400-415 V 50/60 Hz				
Cooling	Capacity (nominal) *1	kW	118.0	124.0	130.0	136.0	140.0
	Power input (nominal)	kW	32.24	33.06	35.81	38.63	39.88
	EER		3.66	3.75	3.63	3.52	3.51
	SEER		7.04	6.89	6.87	6.87	6.88
	Temperature operating field	Indoor WB °C	+15~+24	+15~+24	+15~+24	+15~+24	+15~+24
	Outdoor DB °C	-5~+52	-5~+52	-5~+52	-5~+52	-5~+52	
Heating	Capacity (nominal) *2/ Capacity (max) *3	kW	118.0 / 132.0	124.0 / 140.0	130.0 / 145.0	136.0 / 150.0	140.0 / 156.5
	Power input (nominal)/ Power input (max)	kW	26.75 / 31.88	27.19 / 32.71	29.21 / 34.77	31.26 / 36.85	32.40 / 38.83
	COP/COP max		4.41 / 4.14	4.56 / 4.28	4.45 / 4.17	4.35 / 4.07	4.32 / 4.03
	SCOP		4.15	4.22	4.19	4.15	4.16
	Temperature operating field	Indoor WB °C	+15~+27	+15~+27	+15~+27	+15~+27	+15~+27
	Outdoor DB °C	-20~+15.5	-20~+15.5	-20~+15.5	-20~+15.5	-20~+15.5	
Sound level *4	Sound pression (Sound power) level	dB(A)	68.5/69.0 (86/88)	68.5/69.0 (86/88)	69.0/69.5 (86/88)	70.0/72.0 (88/91)	70.0/72.0 (88/91)
Connectable indoor units	Total Capacity		50-130%	50-130%	50-130%	50-130%	50-130%
	Model/Quantity	CITY MULTI	P10-P250/3-50	P10-P250/3-50	P10-P250/3-50	P10-P250/3-50	P10-P250/3-50
Ø Ref. piping diameter	Liquid	mm	19.05	19.05	19.05	19.05	19.05
	Gas	mm	41.28	41.28	41.28	41.28	41.28
Fan	Type x quantity		Propeller fan x 5	Propeller fan x 6	Propeller fan x 6	Propeller fan x 6	Propeller fan x 6
	Air flow	m³/min	185 + 270 + 270	270 + 270 + 270	270 + 270 + 270	270 + 270 + 270	270 + 270 + 305
Compressor	Type		Inverter scroll hermetic compressor				
	Motor output	kW	5.1 + 9.8 + 9.8	7.7 + 7.7 + 9.8	7.7 + 9.8 + 9.8	9.8 + 9.8 + 9.8	9.8 + 9.8 + 11.1
External dimentions	H(H*5)xWxD	mm	1858(1798)x920x740 1858(1798)x1240x740 1858(1798)x1240x740	1858(1798)x1240x740 1858(1798)x1240x740 1858(1798)x1240x740	1858(1798)x1240x740 1858(1798)x1240x740 1858(1798)x1240x740	1858(1798)x1240x740 1858(1798)x1240x740 1858(1798)x1240x740	1858(1798)x1240x740 1858(1798)x1240x740 1858(1798)x1240x740
	Net weight	kg	228 + 303 + 303	282 + 282 + 303	228 + 303 + 303	303 + 303 + 303	303 + 303 + 303
Refrigerant	Ref. Charge R410	kg	28,1	30,4	30,4	32,4	32,4
	CO ₂ eq.*5	Tons	58,67	63,47	63,47	67,65	67,65

*1~*3 Nominal Conditions:

Cooling conditions: Indoor: 27°C DB / 19°C WB. Outdoor 35°C DB. Piping length 7.5 m, vertical difference 0 m.

Heating conditions: Indoor 20°C DB. Outdoor 7°C DB / 6°C WB. Piping length 7.5 m, vertical difference 0 m.

*2 Eurovent registered

*4 Values measured in anechoic chamber (Cooling mode/Heating mode)

*5 without legs

*6 GWP value of HFC R410A 2088 according to 517 / 2014.

The SEER and SCOP data are based on the EN14825 measurement standard

Technical specifications

MODEL			PUHY-EP1300YSNW-A1 (-BS)	PUHY-EP1350YSNW-A1 (-BS)
HP			52	54
Modules			PUHY-EP(400+450+450)YNW-A1	PUHY-EP(450+450+450)YNW-A1
Power supply	V/Hz/n°		3-phase 4-wire 380-400-415 V 50/60 Hz	
Cooling	Capacity (nominal) *1	kW	146.0	150.0
	Power input (nominal)	kW	41.71	42.85
	EER		3.50	3.50
	SEER		6.90	6.91
	Temperature operating field	Indoor WB °C	+15~+24	+15~+24
	Outdoor DB °C	-5~+52	-5~+52	
Heating	Capacity (nominal) *2/ Capacity (max) *4	kW	146.0 / 163.0	150.0 / 168.0
	Power input (nominal)/ Power input (max)	kW	34.11 / 40.75	35.29 / 42.31
	COP/COP max		4.28 / 4.00	4.25 / 3.97
	SCOP		4.16	4.15
	Temperature operating field	Indoor WB °C	+15~+27	+15~+27
	Outdoor DB °C	-20~+15,5	-20~+15,5	
Sound level **	Sound pression (Sound power) level	dB(A)	70/73,5(88/92)	70.5/74.5 (89/93)
Connectable indoor units	Total Capacity		50-130%	50-130%
	Model/Quantity	CITY MULTI	P10-P250/3-50	P10-P250/3-50
Ø Ref. piping diameter	Liquid	mm	19.05	19.05
	Gas	mm	41.28	41.28
Fan	Type x quantity		Propeller fan x 6	Propeller fan x 6
	Air flow	m³/min	270 + 305 + 305	305 + 305 + 305
Compressor	Type		Inverter scroll hermetic compressor	
	Motor output	kW	9.8 + 11.1 + 11.1	11.1 + 11.1 + 11.1
External dimentions	H(H*5)xWxD	mm	1858(1798)x1240x740	1858(1798)x1240x740
			1858(1798)x1240x740	1858(1798)x1240x740
			1858(1798)x1240x740	1858(1798)x1240x740
Net weight		kg	303 + 303 +303	303 + 303 +303
Refrigerant	Ref. Charge R410	kg	32,4	32,4
	CO ₂ eq.*5	Tons	67,65	67,65

*1*2*3 Nominal Conditions:

Cooling conditions: Indoor: 27°C DB / 19°C WB. Outdoor 35°C DB. Piping length 7.5 m, vertical difference 0 m.

Heating conditions: Indoor 20°C DB. Outdoor 7°C DB / 6°C WB. Piping length 7.5 m, vertical difference 0 m.

** Eurovent registered

** Values measured in anechoic chamber (Cooling mode/Heating mode)

*5 without legs

*6 GWP value of HFC R410A 2088 according to 517 / 2014.

The SEER and SCOP data are based on the EN14825 measurement standard

office



R2 NEXT STAGE LINE

OUTDOOR UNITS - PURY-(E)P Y(S)NW-A1(-BS)



NEW FOUR-SIDED BATTERY

STATIC PRESSURE OF FAN INCREASED UP TO 80 PA.

STATIC PRESSURE OF FAN INCREASED UP TO 80 PA.

CITY MULTI

NEW FAN WITH LOW FRICTION PROFILE

COMPRESSOR OPTIMISED WITH "MULTI-PORT" TECHNOLOGY

NEW AUTO-SHIFT MODE

NEW AUTO-SHIFT MODE PREHEAT DEFROST FUNCTION

ADVANCED ETC CONTROL OF EVAPORATION TEMPERATURE.

FLEXIBLE NOISE SETTING

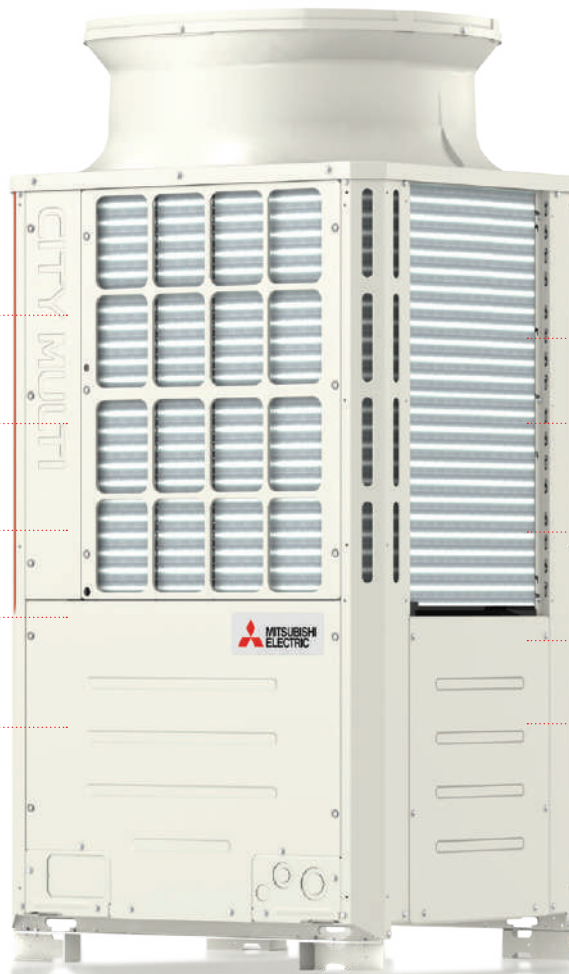

New design

The new outdoor units of the YNW series use a four-sided heat exchanger close to the top of the case near the fan. This technological and construction choice makes it possible to increase heat exchange efficiency.

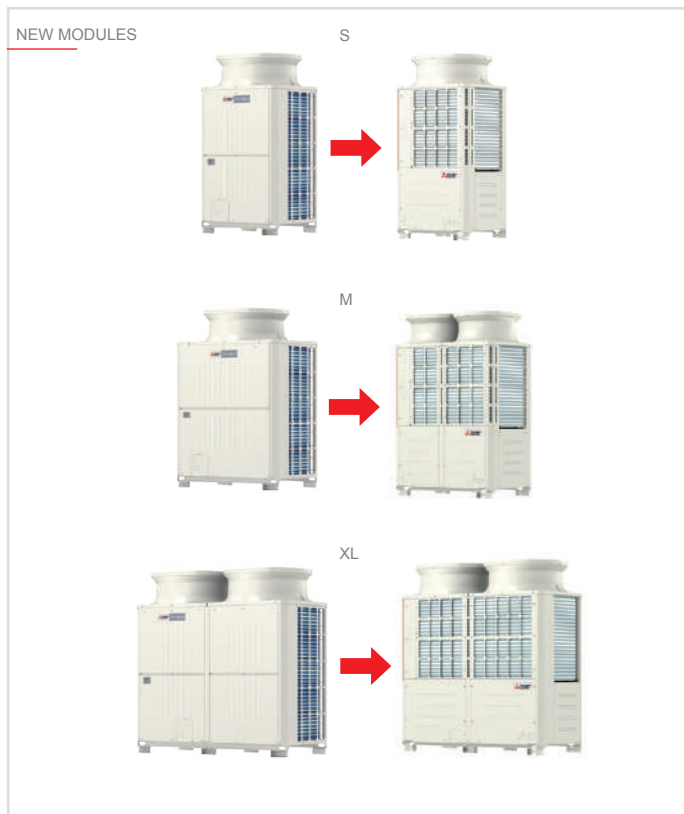
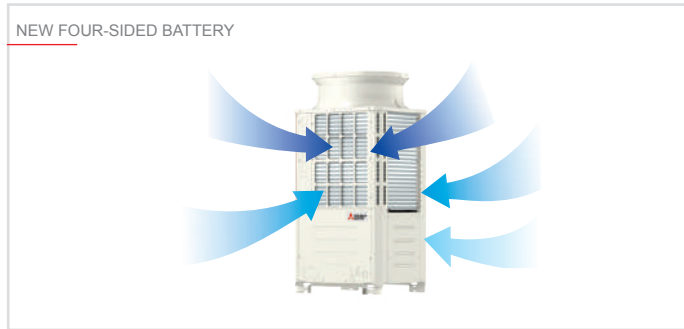

New fan with new blade profile

The fan of the new YNW series has been completely redesigned to fit with the new four-sided battery. The profile of the fins has been optimised to minimise fluid flow losses.

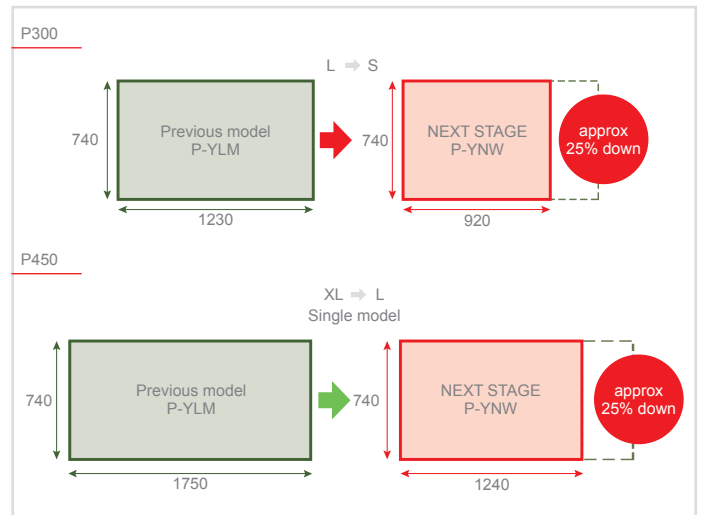
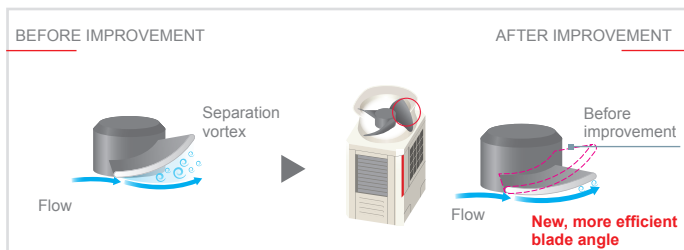

Energy saving

Energy efficiency has been further improved compared to YLM units and now hits top of the range performance values. SEER values have been raised by 139% (P500) compared to the previous model and SCOP values by 49% (P300 and P500). This allows the new YNW units to consume less energy in both cooling and heating. All year-round saving.



Single module

		Previous model	YNW
8HP	P200	S	S
10HP	P250	S	S
12HP	P300	L	S
14HP	P350	L	L
16HP	P400	L	L
18HP	P450	XL	L
20HP	P500	XL	XL

Advanced “Low Noise” function

Low noise” mode can now be selected using five different settings: 85%, 70%, 60% and 50% (values referring to ventilation speed). Noise reduction is directly configurable from the control board of the outdoor unit. Different settings can be selected depending on the installation requirements (in applications with special noise constraints).

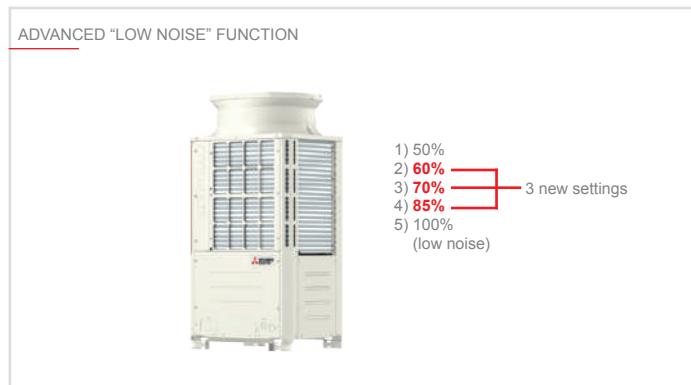

New BC distributor

Increased number of connections (for systems with BC SUB distributor) and increased geometric limits. In the R2 heat recovery systems of the new YNW line, up to 11 BC SUB distributors can be connected to the BC Main distributor, thus allowing greater flexibility of configuration. The adoption of the new architecture allows a reduction of the refrigerant charge in the system.

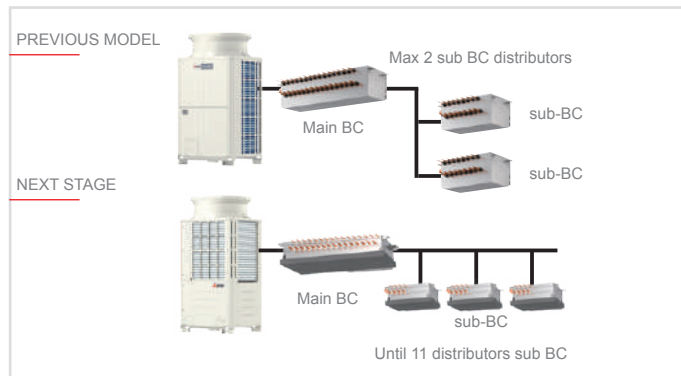

Key Technologies

Technical specifications

MODEL		PURY-P200YNW-A1(-BS)	PURY-P250YNW-A1(-BS)	PURY-P300Y76NW-A1(-BS)	PURY-P350YNW-A1(-BS)	PURY-P400YNW-A1(-BS)	
HP		8	10	12	14	16	
Modules		PURY-P200YNW-A1	PURY-P250YNW-A1	PURY-P300YNW-A1	PURY-P350YNW-A1	PURY-P400YNW-A1	
Power supply	V/Hz/n*	3-fase 380-415V 50Hz					
Cooling	Capacity (nominal) **1	kW	22,4	28,0	33,5	40,0	45,0
	Power input (nominal)	kW	5,27	7,25	8,98	10,98	14,61
	EER		4,25	3,86	3,73	3,64	3,08
	SEER		7,47	6,94	6,62	6,60	6,31
	Temperature operating field	Indoor WB °C	+15~+24	+15~+24	+15~+24	+15~+24	+15~+24
	Outdoor DB °C	-5~+52	-5~+52	-5~+52	-5~+52	-5~+52	
Heating	Capacity (nominal) **2/ Capacity (max) **3	kW	22,4/25,0	28,0/31,5	33,5/37,5	40,0/45,0	45,0/50,0
	Power input (nominal)/ Power input (max)	kW	4,45/5,33	6,22/7,42	8,03/9,54	9,28/11,13	11,65/13,77
	COP/COP max		5,03/4,69	4,50/4,24	4,17/3,93	4,31/4,04	3,86/3,63
	SCOP		3,96	4,05	3,81	3,72	4,10
	Temperature operating field	Indoor WB °C	+15~+27	+15~+27	+15~+27	+15~+27	+15~+27
	Outdoor DB °C	-20~+15,5	-20~+15,5	-20~+15,5	-20~+15,5	-20~+15,5	
Sound level **4	Sound pression (Sound power) level	dB(A)	59/59 (76/78)	60,5/61 (78/80)	61/67 (80/86)	62,5/64 (81/83)	65/69 (83/88)
Connectable indoor units	Total Capacity		50-150%	50-150%	50-150%	50-150%	
	Model/Quantity	CITY MULTI	P10-P250/1-20	P10-P250/1-25	P10-P250/1-30	P10-P250/1-35	P10-P250/1-40
Ø Ref. piping diameter	Liquid	mm	15,88	19,05	19,05	19,05	22,2
	Gas	mm	19,05	22,2	22,2	28,58	28,58
Fan	Type x quantity		Propeller fan x 1	Propeller fan x 1	Propeller fan x 1	Propeller fan x 2	Propeller fan x 2
	Air flow	m³/min	170	185	240	250	315
Compressor	Type		Inverter scroll hermetic				
	Motor output	kW	3,7	5,5	7,3	8,7	11,7
External dimenitions	H(H*5)xWxD	mm	1858(1798)x920x740	1858(1798)x920x740	1858(1798)x920x740	1858(1798)x1240x740	1858(1798)x1240x740
Net weight		kg	214	223	225	269	269
Refrigerant	Ref. Charge R410	kg	5,2	5,2	5,2	8,0	8,0
	CO ₂ eq.**6	Tons	10,85	10,85	10,85	16,70	16,70

12**3 Nominal Conditions:

Cooling conditions: Indoor: 27°C DB / 19°C WB. Outdoor 35°C DB. Piping length 7.5 m, vertical difference 0 m.

Heating conditions: Indoor 20°C DB. Outdoor 7°C DB / 6°C WB. Piping length 7.5 m, vertical difference 0 m.

**2 Eurovent registered

**4 Values measured in anechoic chamber (Cooling mode/Heating mode)

**5 without legs

**6 GWP value of HFC R410A 2088 according to 517 / 2014.

The SEER and SCOP data are based on the EN14825 measurement standard

Technical specifications

MODEL			PURY-P450YNW-A1(-BS)	PURY-P500YNW-A1(-BS)	PURY-P550YNW-A1(-BS)	PURY-P400YSNW-A1(-BS)	PURY-P450YSNW-A1(-BS)	PURY-P500YSNW-A1(-BS)
HP			18	20	22	16	18	20
Modules			PURY-P450YNW-A1	PURY-P500YNW-A1	PURY-P550YNW-A1	PURY-P(200+200)YNW-A1	PURY-P(200+250)YNW-A1	PURY-P(250+250)YNW-A1
Power supply	V/Hz/n°		3-phase 380-415V 50Hz					
Cooling	Capacity (nominal) *1	kW	50,0	56,0	63,0	45,0	50,0	56,0
	Power input (nominal)	kW	14,83	18,54	22,18	10,92	12,72	14,97
	EER		3,37	3,02	2,84	4,12	3,93	3,74
	SEER		6,40	6,32	6,06	7,39	7,09	6,84
	Temperature operating field	Indoor WB °C	+15~+24	+15~+24	+15~+24	+15~+24	+15~+24	+15~+24
	Outdoor DB °C	-5~+52	-5~+52	-5~+52	-5~+52	-5~+52	-5~+52	
Heating	Capacity (nominal) *2/ Capacity (max) *3	kW	50,0/56,0	56,0/63	63,0/69,0	45,0/50,0	50,0/56,0	56,0/63,0
	Power input (nominal)/ Power input (max)	kW	12,46/15,42	14,47/17,50	20,29	9,22/10,98	10,82/12,93	12,81/15,32
	COP/COP max		4,01/3,63	3,87/3,60	3,69	4,88/4,55	4,62/4,33	4,37/4,11
	SCOP		4,03	4,05	4,05	3,84	3,89	3,93
	Temperature operating field	Indoor WB °C	+15~+27	+15~+27	+15~+27	+15~+27	+15~+27	+15~+27
		Outdoor DB °C	-20~+15,5	-20~+15,5	-20~+15,5	-20~+15,5	-20~+15,5	-20~+15,5
Sound level *4	Sound pression (Sound power) level	dB(A)	65,5/70 (83/89)	63,5/64,5 (82/84)	66,0/70,0	62/62 (79/81)	63/63,5 (81/83)	63,5/64 (81/83)
Connectable indoor units	Total Capacity		50-150%	50-150%	50-150%	50-150%	50-150%	50-150%
	Model/Quantity	CITY MULTI	P10-P250/1-45	P10-P250/1-50	P10-P250/2-50	P10-P250/1-40	P10-P250/1-45	P10-P250/1-50
Ø Ref. piping diameter	Liquid	mm	22,2	22,2	22,2	22,2	22,2	22,2
	Gas	mm	28,58	28,58	28,58	28,58	28,58	28,58
Fan	Type x quantity		Propeller fan x 2	Propeller fan x 2	Propeller fan x 2	Propeller fan x 2	Propeller fan x 2	Propeller fan x 2
	Air flow	m³/min	315	295	410	170+170	170+185	185+185
Compressor	Type		Inverter scroll hermetic					
	Motor output	kW	12,4	14,2	17,4	3,7+3,7	3,7+5,5	5,5+5,5
External dimentions	H(H*)xWxD	mm	1858(1798)x1240x740	1858(1798)x1750x740	1858(1798)x1750x740	1858(1798)x920x740 1858(1798)x920x740	1858(1798)x920x740 1858(1798)x920x740	1858(1798)x920x740 1858(1798)x920x740
Net weight		kg	289	335	335 (739)	214+214	214+223	223+223
Refrigerant	Ref. Charge R410	kg	10,8	10,8	10,8	10,4	10,4	10,4
	CO ₂ eq.*6	Tons	22,55	22,55	22,55	21,71	21,71	21,71

Technical specifications

MODEL			PURY-P550YSNW-A1(-BS)	PURY-P600YSNW-A1(-BS)	PURY-P650YSNW-A1(-BS)	PURY-P700YSNW-A1(-BS)	PURY-P750YSNW-A1(-BS)
HP			22	24	26	28	30
Modules			PURY-P(250+300)YNW-A1	PURY-P(300+300)YNW-A1	PURY-P(300+350)YNW-A1	PURY-P(350+350)YNW-A1	PURY-P(350+400)YNW-A1
Power supply	V/Hz/n°		3-phase 380-415V 50Hz				
Cooling	Capacity (nominal) *1	kW	63,0	69,0	73,0	80,0	85,0
	Power input (nominal)	kW	17,11	19,06	20,44	22,66	26,07
	EER		3,68	3,62	3,57	3,53	3,26
	SEER		6,58	6,38	6,26	6,27	6,25
	Temperature operating field	Indoor WB °C	+15~+24	+15~+24	+15~+24	+15~+24	+15~+24
	Outdoor DB °C	-5~+52	-5~+52	-5~+52	-5~+52	-5~+52	
Heating	Capacity (nominal) *2/ Capacity (max) *3	kW	63,0/69,0	69,0/76,5	73,0/81,5	80,0/88,0	85,0/95,0
	Power input (nominal)/ Power input (max)	kW	15,0/17,42	17,07/20,07	17,76/21,05	19,13/22,44	21,46/25,53
	COP/COP max		4,20/3,96	4,04/3,81	4,11/3,87	4,18/3,92	3,96/3,72
	SCOP		3,81	3,69	3,65	3,61	3,61
	Temperature operating field	Indoor WB °C	+15~+27	+15~+27	+15~+27	+15~+27	+15~+27
		Outdoor DB °C	-20~+15,5	-20~+15,5	-20~+15,5	-20~+15,5	-20~+15,5
Sound level *4	Sound pression (Sound power) level	dB(A)	64/68 (83/87)	64/70 (83/89)	65/69 (84/88)	65,5/67 (84/86)	67/70,5 (86/90)
Connectable indoor units	Total Capacity		50-150%	50-150%	50-150%	50-150%	50-150%
	Model/Quantity	CITY MULTI	P10-P250/2-50	P10-P250/2-50	P10-P250/2-50	P10-P250/2-50	P10-P250/2-50
Ø Ref. piping diameter	Liquid	mm	22,2	22,2	28,58	28,58	28,58
	Gas	mm	28,58	28,58	28,58	34,93	34,93
Fan	Type x quantity		Propeller fan x 2	Propeller fan x 2	Propeller fan x 3	Propeller fan x 4	Propeller fan x 4
	Air flow	m³/min	185+240	240+240	240+250	250+250	250+315
Compressor	Type		Inverter scroll hermetic				
	Motor output	kW	5,5+7,3	7,3+7,3	7,3+8,7	8,7+8,7	8,7+11,7
External dimentions	H(H*)xWxD	mm	1858(1798)x920x740 1858(1798)x920x740	1858(1798)x920x740 1858(1798)x920x740	1858(1798)x920x740 1858(1798)x1240x740	1858(1798)x1240x740 1858(1798)x1240x740	1858(1798)x1240x740 1858(1798)x1240x740
Net weight		kg	223+225	225+225	225+269	269+269	269+269
Refrigerant	Ref. Charge R410	kg	10,4	10,4	13,2	16	16
	CO ₂ eq.*6	Tons	21,71	21,71	27,56	33,40	33,40

*1~*3 Nominal Conditions:

Cooling conditions: Indoor: 27°C DB / 19°C WB. Outdoor 35°C DB. Piping length 7.5 m, vertical difference 0 m.

Heating conditions: Indoor 20°C DB. Outdoor 7°C DB / 6°C WB. Piping length 7.5 m, vertical difference 0 m.

*2 Eurovent registered

*4 Values measured in anechoic chamber (Cooling mode/Heating mode)

*5 without legs

*6 GWP value of HFC R410A 2088 according to 517 / 2014.

The SEER and SCOP data are based on the EN14825 measurement standard

Technical specifications

MODEL			PURY-P800YSNW-A1(-BS)	PURY-P850YSNW-A1(-BS)	PURY-P900YSNW-A1(-BS)	PURY-P950YSNW-A1(-BS)	PURY-P1000YSNW-A1(-BS)
HP			32	34	36	38	40
Modules			PURY-P(400+400)YNW-A1	PURY-P(400+450)YNW-A1	PURY-P(450+450)YNW-A1	PURY-P(450+500)YNW-A1	PURY-P(500+500)YNW-A1
Power supply	V/Hz/n°		3-phase 380-415V 50Hz				
Cooling	Capacity (nominal) **1	kW	90,0	96,0	101,0	108,0	113,0
	Power input (nominal)	kW	30,10	30,67	30,88	34,83	38,56
	EER		2,99	3,13	3,27	3,10	2,93
	SEER		6,22	6,30	6,33	6,22	6,05
	Temperature operating field	Indoor WB °C	+15~+24	+15~+24	+15~+24	+15~+24	+15~+24
	Outdoor DB °C	-5~+52	-5~+52	-5~+52	-5~+52	-5~+52	
Heating	Capacity (nominal) **2/ Capacity (max) **3	kW	90,0/100,0	96,0/108,0	101,0/113	108,0/119,5	113,0/127,0
	Power input (nominal)/ Power input (max)	kW	24,06/28,40	25,13/30,68	25,96/32,10	28,27/34,04	30,13/36,38
	COP/COP max		3,74/3,52	3,82/3,52	3,89/3,52	3,82/3,51	3,75/3,49
	SCOP		3,97	3,93	3,90	3,92	3,92
	Temperature operating field	Indoor WB °C	+15~+27	+15~+27	+15~+27	+15~+27	+15~+27
	Outdoor DB °C	-20~+15,5	-20~+15,5	-20~+15,5	-20~+15,5	-20~+15,5	
Sound level **4	Sound pression (Sound power) level	dB(A)	68/72 (86/91)	68,5/72,5 (86/92)	68,5/73,0 (86/92)	68/71,5 (86/91)	66,5/67,5 (85/87)
Connectable indoor units	Total Capacity		50-150%	50-150%	50-150%	50-150%	50-150%
	Model/Quantity	CITY MULTI	P10-P250/2-50	P10-P250/2-50	P10-P250/2-50	P10-P250/2-50	P10-P250/2-50
Ø Ref. piping diameter	Liquid	mm	28,58	28,58	28,58	28,58	28,58
	Gas	mm	34,93	41,28	41,28	41,28	41,28
Fan	Type x quantity		Propeller fan x 4	Propeller fan x 4	Propeller fan x 4	Propeller fan x 4	Propeller fan x 4
	Air flow	m³/min	315+315	315+315	315+315	315+295	295+295
Compressor	Type		Inverter scroll hermetic				
	Motor output	kW	11,7+11,7	11,7+12,4	12,4+12,4	12,4+14,2	14,2+14,2
External dimentions	H(H*5)xWxD	mm	1858(1798)x1240x740 1858(1798)x1240x740	1858(1798)x1240x740 1858(1798)x1240x740	1858(1798)x1240x740 1858(1798)x1240x740	1858(1798)x1240x740 1858(1798)x1750x740	1858(1798)x1750x740 1858(1798)x1750x740
Net weight		kg	269+269	269+289	289+289	289+335	335+335
Refrigerant	Ref. Charge R410	kg	16	18,8	21,6	21,6	21,6
	CO ₂ eq.**6	Tons	33,40	39,25	45,1	45,1	45,1

Technical specifications

MODEL			PURY-P1050YSNW-A1(-BS)	PURY-P1100YSNW-A1(-BS)
HP			42	44
Modules			PURY-P(500+550)YNW-A1	PURY-P(550+550)YNW-A1
Power supply	V/Hz/n°		3-phase 380-415V 50Hz	
Cooling	Capacity (nominal) **1	kW	118,0	124,0
	Power input (nominal)	kW	41,54	45,09
	EER		2,84	2,75
	SEER		5,90	5,77
	Temperature operating field	Indoor WB °C	+15~+24	+15~+24
	Outdoor DB °C	-5~+52	-5~+52	
Heating	Capacity (nominal) **2/ Capacity (max) **3	kW	118,0/132,0	124,0/140,0
	Power input (nominal)/ Power input (max)	kW	32,15/38,82	34,63/42,42
	COP/COP max		3,67/3,40	3,58/3,30
	SCOP		3,92	3,92
	Temperature operating field	Indoor WB °C	+15~+27	+15~+27
	Outdoor DB °C	-20~+15,5	-20~+15,5	
Sound level **4	Sound pression (Sound power) level	dB(A)	68/73 (86/91)	69/73 (86/92)
Connectable indoor units	Total Capacity		50-150%	50-150%
	Model/Quantity	CITY MULTI	P10-P250/3-50	P10-P250/3-50
Ø Ref. piping diameter	Liquid	mm	34,93	34,93
	Gas	mm	41,28	41,28
Fan	Type x quantity		Propeller fan x 4	Propeller fan x 4
	Air flow	m³/min	295+410	410+410
Compressor	Type		Inverter scroll hermetic	
	Motor output	kW	14,2+17,4	17,4+17,4
External dimentions	H(H*5)xWxD	mm	1858(1798)x1750x740 1858(1798)x1750x740	1858(1798)x1750x740 1858(1798)x1750x740
Net weight		kg	335+335	335+335
Refrigerant	Ref. Charge R410	kg	21,6	21,6
	CO ₂ eq.**6	Tons	45,1	45,1

12**3 Nominal Conditions:

Cooling conditions: Indoor: 27°C DB / 19°C WB, Outdoor 35°C DB, Piping length 7.5 m, vertical difference 0 m.

Heating conditions: Indoor 20°C DB, Outdoor 7°C DB / 6°C WB, Piping length 7.5 m, vertical difference 0 m.

**2 Eurovent registered

**3 Values measured in anechoic chamber (Cooling mode/Heating mode)

**4 without legs

**5 GWP value of HFC R410A 2088 according to 517 / 2014.

The SEER and SCOP data are based on the EN14825 measurement standard

Technical specifications

MODEL			PURY-EP200YNW-A1(-BS)	PURY-EP250YNW-A1(-BS)	PURY-EP300YNW-A1(-BS)	PURY-EP350YNW-A1(-BS)	PURY-EP400YNW-A1(-BS)
HP			8	10	12	14	16
Modules			PURY-EP200YNW-A1	PURY-EP250YNW-A1	PURY-EP300YNW-A1	PURY-EP350YNW-A1	PURY-EP400YNW-A1
Power supply	V/Hz/n°		3-phase 4-wire 380-400-415 V 50/60 Hz				
Cooling	Capacity (nominal) **	kW	22.4	28.0	33.5	40.0	45.0
	Power input (nominal)	kW	4.74	6.89	8.17	9.97	13.04
	EER		4.72	4.06	4.10	4.01	3.45
	SEER		7.66	7.23	6.77	6.66	6.63
	Temperature operating field	Indoor WB °C	+15~+24	+15~+24	+15~+24	+15~+24	+15~+24
	Outdoor DB °C	-5~+52	-5~+52	-5~+52	-5~+52	-5~+52	
Heating	Capacity (nominal) **/ Capacity (max) **	kW	22.4 / 25.0	28.0 / 31.5	33.5 / 37.5	40.0 / 45.0	45.0 / 50.0
	Power input (nominal)/ Power input (max)	kW	4.40 / 5.25	6.18 / 7.37	8.01 / 9.51	9.23 / 11.08	11.42 / 13.58
	COP/COP max		5.09 / 4.76	4.53 / 4.27	4.18 / 3.94	4.33 / 4.06	3.94 / 3.68
	SCOP		4.00	4.24	4.12	4.12	4.12
	Temperature operating field	Indoor WB °C	+15~+27	+15~+27	+15~+27	+15~+27	+15~+27
	Outdoor DB °C	-20~+15,5	-20~+15,5	-20~+15,5	-20~+15,5	-20~+15,5	
Sound level **	Sound pressure (Sound power) level	dB(A)	59.0/59.0 (76/78)	60.5/61.0 (78/80)	61.0/67.0 (80/86)	62.5/64.0 (81/83)	65.0/69.0 (83/88)
Connectable indoor units	Total Capacity		50-150%	50-150%	50-150%	50-150%	50-150%
	Model/Quantity	CITY MULTI	P10-P250/1-20	P10-P250/1-25	P10-P250/1-30	P10-P250/1-35	P10-P250/1-40
Ø Ref. piping diameter	Liquid	mm	15.88	19.05	19.05	19.05	22.2
	Gas	mm	19.05	22.2	22.2	28.58	28.58
Fan	Type x quantity		Propeller fan x 1	Propeller fan x 1	Propeller fan x 1	Propeller fan x 2	Propeller fan x 2
	Air flow	m³/min	170	185	240	250	315
Compressor	Type		Inverter scroll hermetic				
	Motor output	kW	3.6	5.5	7.3	8.7	10.8
External dimensions	H(H*)xWxD	mm	1858(1798)x920x740	1858(1798)x920x740	1858(1798)x920x740	1858(1798)x1240x740	1858(1798)x1240x740
Net weight		kg	219	228	230	275	276
Refrigerant	Ref. Charge R410	kg	5,2	5,2	5,2	8	8
	CO ₂ eq.**6	Tons	10,85	10,85	10,85	16,70	16,70

Technical specifications

MODEL			PURY-EP450YNW-A1(-BS)	PURY-EP500YNW-A1(-BS)	PURY-EP550YNW-A1(-BS)	PURY-EP400YSNW-A1(-BS)	PURY-EP450YSNW-A1(-BS)
HP			18	20	22	16	18
Modules			PURY-EP450YNW-A1	PURY-EP500YNW-A1	PURY-EP550YNW-A1	PURY-EP(200+200)YNW-A1	PURY-EP(200+250)YNW-A1
Power supply	V/Hz/n°		3-phase 4-wire 380-400-415 V 50/60 Hz				
Cooling	Capacity (nominal) **	kW	50.0	56.0	63.0	45.0	50.0
	Power input (nominal)	kW	13.85	18.12	22.00	9.82	11.73
	EER		3.61	3.09	2.86	4.58	4.26
	SEER		6.61	6.47	6.21	7.60	7.32
	Temperature operating field	Indoor WB °C	+15~+24	+15~+24	+15~+24	+15~+24	+15~+24
	Outdoor DB °C	-5~+52	-5~+52	-5~+52	-5~+52	-5~+52	
Heating	Capacity (nominal) **/ Capacity (max) **	kW	50.0 / 56.0	56.0 / 63.0	63.0 / 69.0	45.0 / 50.0	50.0 / 56.0
	Power input (nominal)/ Power input (max)	kW	12.16 / 14.62	14.35 / 17.35	16.55 / 19.71	9.10 / 10.82	10.70 / 12.78
	COP/COP max		4.11 / 3.83	3.90 / 3.63	3.80 / 3.50	4.94 / 4.62	4.67 / 4.38
	SCOP		4.10	4.09	4.09	3.88	4.01
	Temperature operating field	Indoor WB °C	+15~+27	+15~+27	+15~+27	+15~+27	+15~+27
	Outdoor DB °C	-20~+15,5	-20~+15,5	-20~+15,5	-20~+15,5	-20~+15,5	
Sound level **	Sound pressure (Sound power) level	dB(A)	65.5/70.0 (83/89)	63.5/64.5 (82/84)	66.0/70.0 (83/89)	62.0/62.0 (79/81)	63.0/63.5 (81/83)
Connectable indoor units	Total Capacity		50-150%	50-150%	50-150%	50-150%	50-150%
	Model/Quantity	CITY MULTI	P10-P250/1-45	P10-P250/1-50	P10-P250/2-50	P10-P250/1-40	P10-P250/1-45
Ø Ref. piping diameter	Liquid	mm	22.2	22.2	22.2	22.2	22.2
	Gas	mm	28.58	28.58	28.58	28.58	28.58
Fan	Type x quantity		Propeller fan x 2	Propeller fan x 2	Propeller fan x 2	Propeller fan x 2	Propeller fan x 2
	Air flow	m³/min	315	295	410	170 + 170	170 + 185
Compressor	Type		Inverter scroll hermetic				
	Motor output	kW	11.7	13.8	17.2	3.6 + 3.6	3.6 + 5.5
External dimensions	H(H*)xWxD	mm	1858(1798)x1240x740	1858(1798)x1750x740	1858(1798)x1750x740	1858(1798)x920x740 1858(1798)x920x740	1858(1798)x920x740 1858(1798)x920x740
Net weight		kg	301	346	346	219 + 219	219 + 228
Refrigerant	Ref. Charge R410	kg	10,8	10,8	10,8	10,4	10,4
	CO ₂ eq.**6	Tons	22,55	22,55	22,55	21,71	21,71

**2*3 Nominal Conditions:

Cooling conditions: Indoor: 27°C DB / 19°C WB. Outdoor 35°C DB. Piping length 7.5 m, vertical difference 0 m.

Heating conditions: Indoor 20°C DB. Outdoor 7°C DB / 6°C WB. Piping length 7.5 m, vertical difference 0 m.

** Eurovent registered

** Values measured in anechoic chamber (Cooling mode/Heating mode)

** without legs

** GWP value of HFC R410A 2088 according to 517 / 2014.

The SEER and SCOP data are based on the EN14825 measurement standard

Technical specifications

MODEL			PURY-EP500YSNW-A1(-BS)	PURY-EP550YSNW-A1(-BS)	PURY-EP600YSNW-A1(-BS)	PURY-EP650YSNW-A1(-BS)	PURY-EP700YSNW-A1(-BS)
HP			20	22	24	26	28
Modules			PURY-EP(250+250)YNW-A1	PURY-EP(250+300)YNW-A1	PURY-EP(300+300)YNW-A1	PURY-EP(300+350)YNW-A1	PURY-EP(350+350)YNW-A1
Power supply	V/Hz/n°		3-phase 4-wire 380-400-415 V 50/60 Hz				
Cooling	Capacity (nominal) **	kW	56.0	63.0	69.0	73.0	80.0
	Power input (nominal)	kW	14.21	15.90	17.33	18.57	20.56
	EER		3.94	3.96	3.98	3.93	3.89
	SEER		7.12	6.85	6.61	6.50	6.52
	Temperature operating field	Indoor WB °C	+15~+24	+15~+24	+15~+24	+15~+24	+15~+24
	Outdoor DB °C	-5~+52	-5~+52	-5~+52	-5~+52	-5~+52	
Heating	Capacity (nominal) **/ Capacity (max) **	kW	56.0 / 63.0	63.0 / 69.0	69.0 / 76.5	73.0 / 81.5	80.0 / 88.0
	Power input (nominal)/ Power input (max)	kW	12.75 / 15.21	14.92 / 17.33	17.03 / 20.02	17.67 / 21.00	19.04 / 22.33
	COP/COP max		4.39 / 4.14	4.22 / 3.98	4.05 / 3.82	4.13 / 3.88	4.20 / 3.94
	SCOP		4.11	4.05	3.99	3.99	3.99
	Temperature operating field	Indoor WB °C	+15~+27	+15~+27	+15~+27	+15~+27	+15~+27
	Outdoor DB °C	-20~+15,5	-20~+15,5	-20~+15,5	-20~+15,5	-20~+15,5	
Sound level **	Sound pressure (Sound power) level	dB(A)	63.5/64.0 (81/83)	64.0/68.0 (83/87)	64.0/70.0 (83/89)	65.0/69.0 (84/88)	65.5/67.0 (84/86)
Connectable indoor units	Total Capacity		50-150%	50-150%	50-150%	50-150%	50-150%
	Model/Quantity	CITY MULTI	P10-P250/1-50	P10-P250/2-50	P10-P250/2-50	P10-P250/2-50	P10-P250/2-50
Ø Ref. piping diameter	Liquid	mm	22.2	22.2	22.2	28.58	28.58
	Gas	mm	28.58	28.58	28.58	28.58	34.93
Fan	Type x quantity		Propeller fan x 2	Propeller fan x 2	Propeller fan x 2	Propeller fan x 3	Propeller fan x 4
	Air flow	m³/min	185 + 185	185 + 240	240 + 240	240 + 250	250 + 250
Compressor	Type		Inverter scroll hermetic				
	Motor output	kW	5.5 + 5.5	5.5 + 7.3	7.3 + 7.3	7.3 + 8.7	8.7 + 8.7
External dimensions	H(H*)xWxD	mm	1858(1798)x920x740 1858(1798)x920x740	1858(1798)x920x740 1858(1798)x920x740	1858(1798)x920x740 1858(1798)x920x740	1858(1798)x920x740 1858(1798)x1240x740	1858(1798)x1240x740 1858(1798)x1240x740
Net weight		kg	228 + 228	228 + 230	230 + 230	230 + 275	275 + 275
Refrigerant	Ref. Charge R410	kg	10,4	10,4	10,4	13,2	16
	CO ₂ eq.**	Tons	21,71	21,71	21,71	27,56	33,40

Technical specifications

MODEL			PURY-EP750YSNW-A1(-BS)	PURY-EP800YSNW-A1(-BS)	PURY-EP850YSNW-A1(-BS)	PURY-EP900YSNW-A1(-BS)	PURY-EP950YSNW-A1(-BS)
HP			30	32	34	36	38
Modules			PURY-EP(350+400)YNW-A1	PURY-EP(400+400)YNW-A1	PURY-EP(400+450)YNW-A1	PURY-EP(450+450)YNW-A1	PURY-EP(450+500)YNW-A1
Power supply	V/Hz/n°		3-phase 4-wire 380-400-415 V 50/60 Hz				
Cooling	Capacity (nominal) **	kW	85.0	90.0	96.0	101.0	108.0
	Power input (nominal)	kW	23.48	26.86	28.07	28.85	33.23
	EER		3.62	3.35	3.42	3.50	3.25
	SEER		6.49	6.44	6.52	6.56	6.46
	Temperature operating field	Indoor WB °C	+15~+24	+15~+24	+15~+24	+15~+24	+15~+24
	Outdoor DB °C	-5~+52	-5~+52	-5~+52	-5~+52	-5~+52	
Heating	Capacity (nominal) **/ Capacity (max) **	kW	85.0 / 95.0	90.0 / 100.0	96.0 / 108.0	101.0 / 113.0	108.0 / 119.5
	Power input (nominal)/ Power input (max)	kW	21.19 / 25.33	23.56 / 28.01	24.61 / 29.67	25.31 / 30.37	27.83 / 33.01
	COP/COP max		4.01 / 3.75	3.82 / 3.57	3.90 / 3.64	3.99 / 3.72	3.88 / 3.62
	SCOP		3.99	3.99	3.98	3.97	3.97
	Temperature operating field	Indoor WB °C	+15~+27	+15~+27	+15~+27	+15~+27	+15~+27
	Outdoor DB °C	-20~+15,5	-20~+15,5	-20~+15,5	-20~+15,5	-20~+15,5	
Sound level **	Sound pressure (Sound power) level	dB(A)	67.0/70.5 (86/90)	68.0/72.0 (86/91)	68.5/72.5 (86/92)	68.5/73.0 (86/92)	68.0/71.5 (86/91)
Connectable indoor units	Total Capacity		50-150%	50-150%	50-150%	50-150%	50-150%
	Model/Quantity	CITY MULTI	P10-P250/2-50	P10-P250/2-50	P10-P250/2-50	P10-P250/2-50	P10-P250/2-50
Ø Ref. piping diameter	Liquid	mm	28.58	28.58	28.58	28.58	28.58
	Gas	mm	34.93	34.93	41.28	41.28	41.28
Fan	Type x quantity		Propeller fan x 4	Propeller fan x 4	Propeller fan x 4	Propeller fan x 4	Propeller fan x 4
	Air flow	m³/min	250 + 315	315 + 315	315 + 315	315 + 315	315 + 295
Compressor	Type		Inverter scroll hermetic				
	Motor output	kW	8.7 + 10.8	10.8 + 10.8	10.8 + 11.7	11.7 + 11.7	11.7 + 13.8
External dimensions	H(H*)xWxD	mm	1858(1798)x1240x740 1858(1798)x1240x740	1858(1798)x1240x740 1858(1798)x1240x740	1858(1798)x1240x740 1858(1798)x1240x740	1858(1798)x1240x740 1858(1798)x1240x740	1858(1798)x1240x740 1858(1798)x1240x740
Net weight		kg	275 + 276	276 + 276	276 + 301	301 + 301	301 + 346
Refrigerant	Ref. Charge R410	kg	16	18	18,8	21,6	21,6
	CO ₂ eq.**	Tons	33,40	37,58	39,25	45,1	45,1

**1+2+3 Nominal Conditions:

Cooling conditions: Indoor: 27°C DB / 19°C WB. Outdoor 35°C DB. Piping length 7.5 m, vertical difference 0 m.

Heating conditions: Indoor 20°C DB. Outdoor 7°C DB / 6°C WB. Piping length 7.5 m, vertical difference 0 m.

** Eurovent registered

** Values measured in anechoic chamber (Cooling mode/Heating mode)

** without legs

** GWP value of HFC R410A 2088 according to 517 / 2014.

The SEER and SCOP data are based on the EN14825 measurement standard

Technical specifications

MODEL			PURY-EP1000YSNW-A1(-BS)	PURY-EP1050YSNW-A1(-BS)	PURY-EP1100YSNW-A1(-BS)
HP			40	42	44
Modules			PURY-EP(500+500)YNW-A1	PURY-EP(500+550)YNW-A1	PURY-EP(550+550)YNW-A1
Power supply	V/Hz/n°		3-phase 4-wire 380-400-415 V 50/60 Hz		
Cooling	Capacity (nominal) ^{*1}	kW	113.0	118.0	124.0
	Power input (nominal)	kW	37.66	40.83	44.76
	EER		3.00	2.89	2.77
	SEER		6.34	6.19	6.06
	Temperature operating field	Indoor WB °C	+15~+24	+15~+24	+15~+24
	Outdoor DB °C	-5~+52	-5~+52	-5~+52	
Heating	Capacity (nominal) ^{*2} / Capacity (max) ^{*3}	kW	113.0 / 127.0	118.0 / 132.0	124.0 / 140.0
	Power input (nominal)/ Power input (max)	kW	29.89 / 36.07	31.63 / 38.15	33.60 / 41.17
	COP/COP max		3.78 / 3.52	3.73 / 3.46	3.69 / 3.40
	SCOP		3.96	3.96	3.96
	Temperature operating field	Indoor WB °C	+15~+27	+15~+27	+15~+27
	Outdoor DB °C	-20~+15,5	-20~+15,5	-20~+15,5	
Sound level ^{*4}	Sound pression (Sound power) level	dB(A)	66.5/67.5 (85/87)	68.0/73.0 (86/91)	69.0/73.0 (86/92)
Connectable indoor units	Total Capacity		50-150%	50-150%	50-150%
	Model/Quantity	CITY MULTI	P10-P250/2-50	P10-P250/2-50	P10-P250/2-50
Ø Ref. piping diameter	Liquid	mm	28.58	34.93	34.93
	Gas	mm	41.28	41.28	41.28
Fan	Type x quantity		Propeller fan x 4	Propeller fan x 4	Propeller fan x 4
	Air flow	m³/min	295 + 295	295 + 410	410 + 410
Compressor	Type		Inverter scroll hermetic		
	Motor output	kW	13.8 + 13.8	13.8 + 17.2	17.2 + 17.2
External dimentions	H(H*5)xWxD	mm	1858(1798)x1750x740 1858(1798)x1750x740	1858(1798)x1750x740 1858(1798)x1750x740	1858(1798)x1750x740 1858(1798)x1750x740
	Net weight	kg	346 + 346	346 + 346	346 + 346
Refrigerant	Ref. Charge R410	kg	21,6	21,6	21,6
	CO ₂ eq. ^{*6}	Tons	45,1	45,1	45,1

^{*1}^{*2}^{*3} Nominal Conditions:

Cooling conditions: Indoor: 27°C DB / 19°C WB. Outdoor 35°C DB. Piping length 7.5 m, vertical difference 0 m.

Heating conditions: Indoor 20°C DB. Outdoor 7°C DB / 6°C WB. Piping length 7.5 m, vertical difference 0 m.

^{*2} Eurovent registered

^{*4} Values measured in anechoic chamber (Cooling mode/Heating mode)

^{*5} without legs

^{*6} GWP value of HFC R410A 2088 according to 517 / 2014.

The SEER and SCOP data are based on the EN14825 measurement standard

WY WR2 LINE

OUTDOOR UNITS - Water condensed Heat pump and Heat recovery PQH(R)Y-P Y(S)LM-A1



WEIGHT REDUCED UP TO -44% COMPARED TO PREVIOUS MODEL

WIDER LINEUP INTRODUCING 14HP SIZE

SINGLE MODULE UP TO SIZE 24HP FOR EASIER INSTALLATION AND LESS ENCUMBRANCE

HIGHER EFFICIENCY THAN PREVIOUS MODEL (UP TO +20% EER AND +34% COP)

NEW CASE IN SMALL AND LARGE VERSIONS

EVAPORATING TEMPERATURE CONTROL (ETC) FEATURE AVAILABLE

WATER FLOW AUTOMATIC CONTROL WITH 0-10V INPUT

FOR SIZES P700-P900 (28-36HP) REDUCED OCCUPIED SURFACE.



*1 Values referring to the model PQHY-P600 YSLM-A compared to the same size as the previous series
*2 Value referred to the model P400 compared with the same size as the previous model

New Small and Large case

New water condensed outdoor units WY and WR2 are available in two module types: Small and Large. Large module allows capacity up to 24HP (69 kW in Cooling and 76,5 kW in Heating) with just one module, reducing occupied surface in installation site up to 50% compared to previous model. For double module configuration room saving can be up to 33%.

Weight reduction

A significant weight reduction compared to previous model, up to 44% with Large module, allows an easier installation and transportation of the unit.

Higher energy efficiency

New WY and WR2 model grants top of the class EER and COP performances. Energy efficiency has been improved for both single and double module, in Cooling and Heating, up to +34%. This type of systems are among the most efficient in the world, thanks to high performances and constant temperature attributes of geothermal application.

	PQHY		PQRY	
	Y(S)HM	Y(S)LM	Y(S)HM	Y(S)LM
P200	195	174	181	172
P250	195	174	181	172
P300	195	174	181	172
P350	-	217	-	216
P400	390	217 ¹	362	216 ¹
		348		344 ²
P450	390	217 ¹	362	216 ¹
		348		344 ²
P500	390	217 ¹	362	216 ¹
		348		344 ²
P550	390	246 ¹	362	246 ¹
		348 ²		344 ²
P600	390	246 ¹	362	246 ¹
		348 ²		344 ²
P700	585	434	-	432
P750	585	434	-	432
P800	585	434	-	432
P850	585	434	-	432
P900	585	434	-	432

*1 Single module
*2 Double module

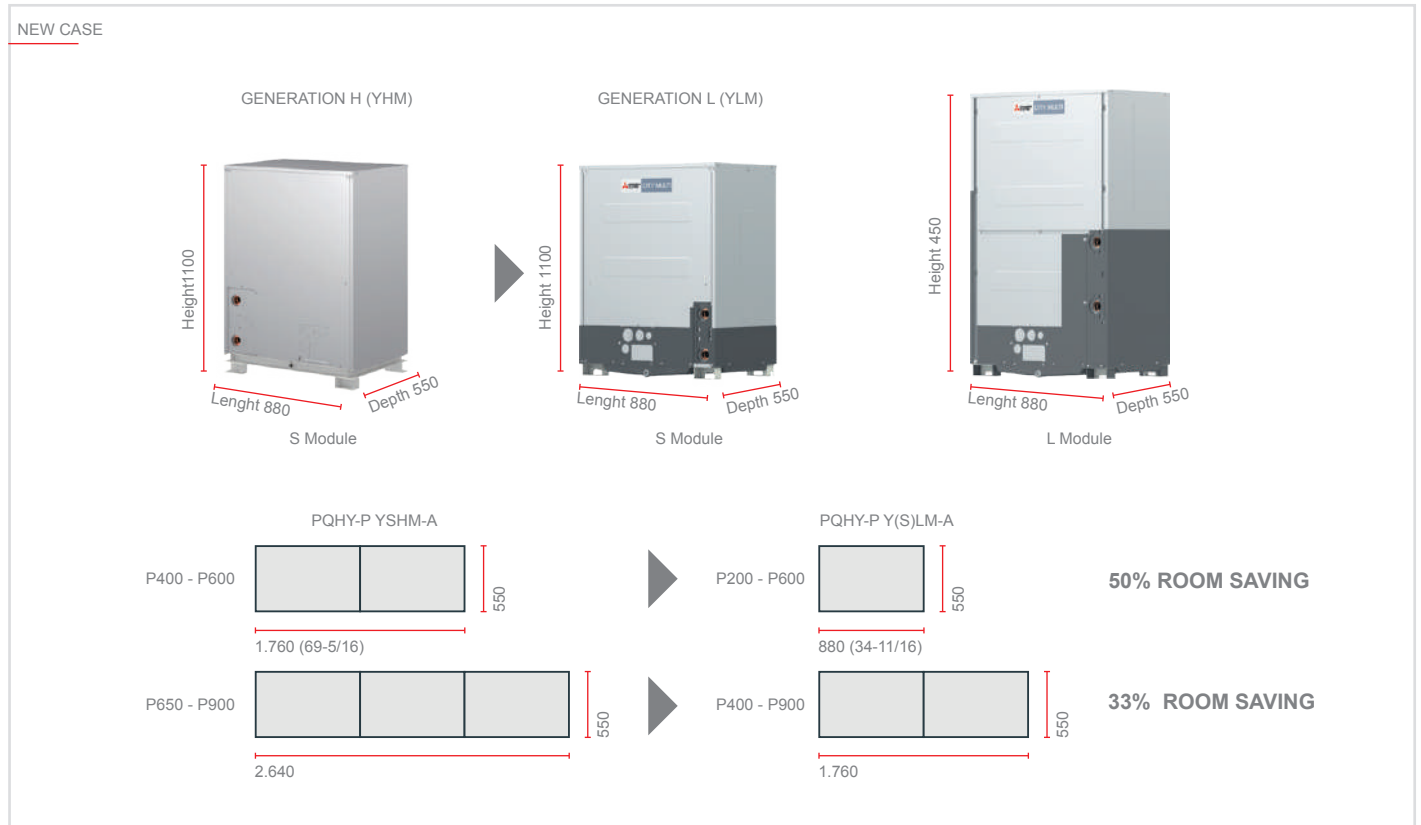
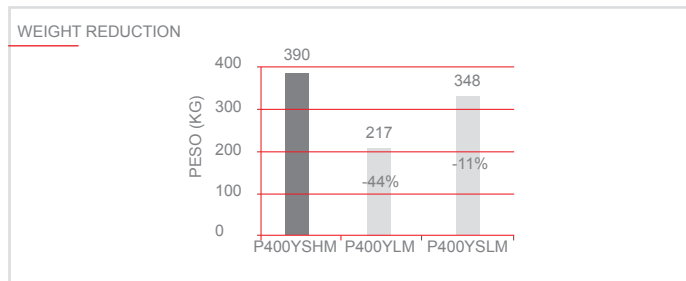

Water flow rate control

New YLM water condensed outdoor units are equipped with an automatic flow rate control system, which allows reduction of pumping consumption when the system works in partial load conditions. Flow rate control is performed by a 0-10V signal, which controls the regulation valve by shutting or opening it (field supplied).

Thanks to factory setting water circulation pumping is performed even during temporary blackout.

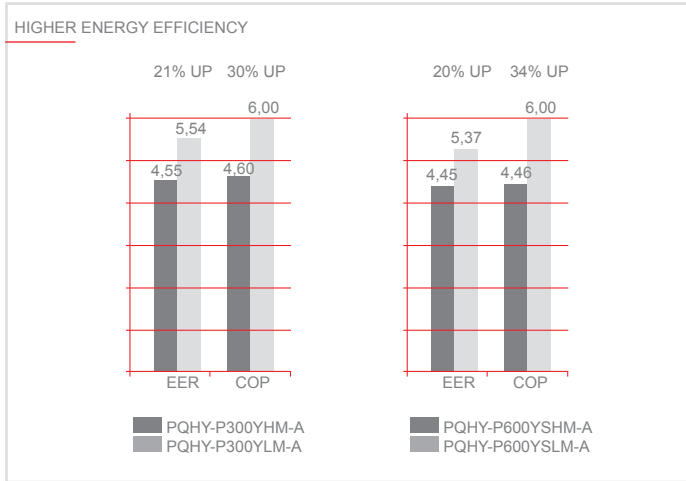

Advantages

WY and WR2 lines VRF CITY MULTI systems have all the benefits of the Y series, using water evaporation condensing units. Water heat source condensing units offer the advantage of being installable inside the building, for even greater installation flexibility with practically no limitations for the dimensions of the infrastructure. Depending on the capacity of the outdoor unit, up to 26 indoor units can be connected to a single condensing unit, while up to 50 indoor units can be connected to a modular system with individual user and/or centralized control. The two-pipe system allows the system to transition from heating to cooling mode and vice versa, for superior comfort in all zones.

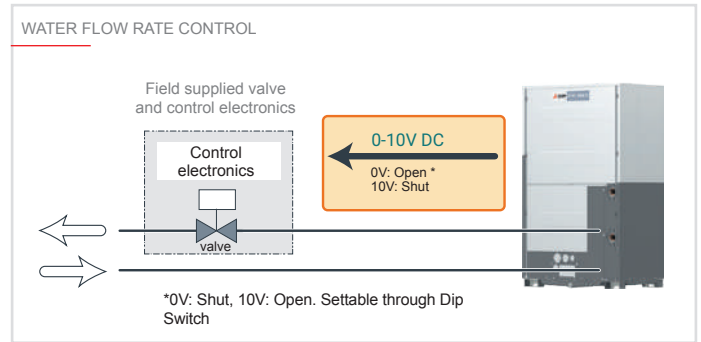







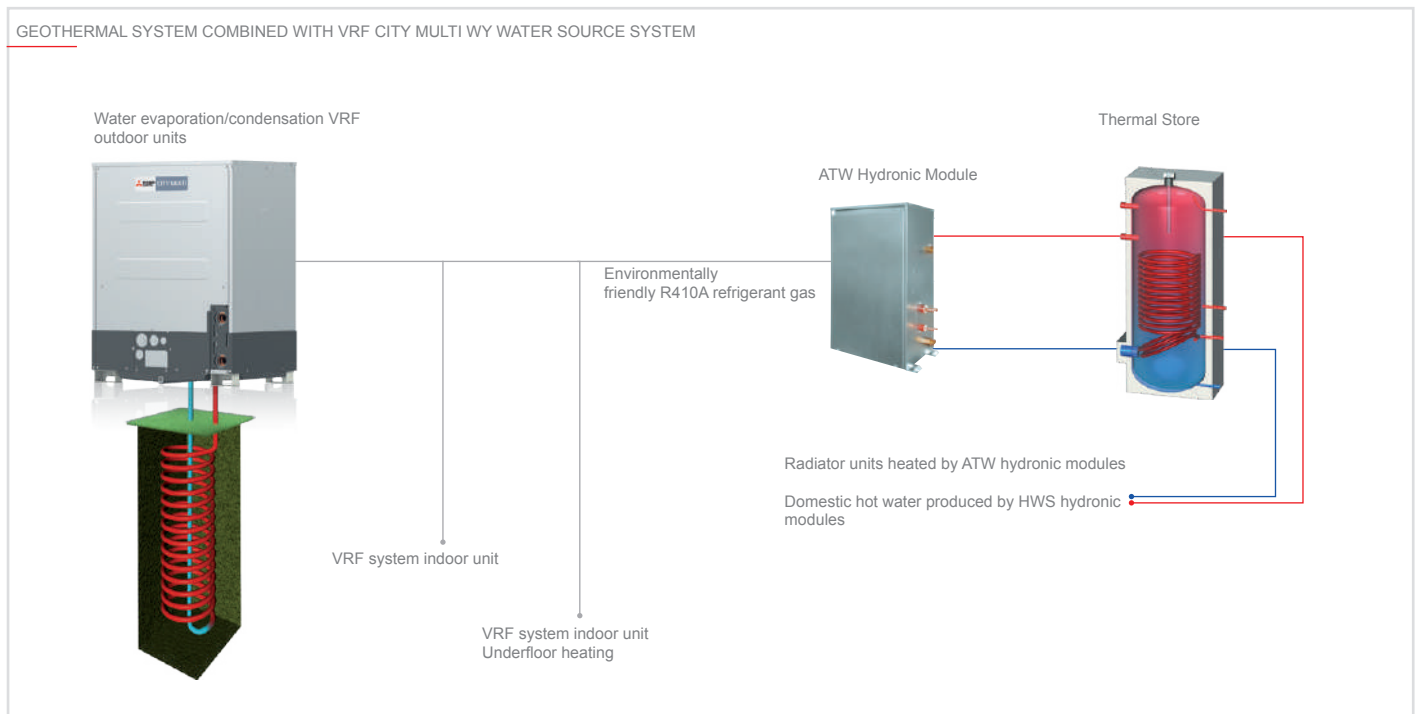

Geothermal applications

WY and WR2 lines outdoor units are perfectly suited for geothermal applications as they use water as the thermal medium fluid which, at depths from 10 m below ground, maintains a practically constant temperature with no significant excursions all year round.

A geothermal installation uses the ground as a heat source in winter and as a heat sink in summer. Using geothermal probes (heat exchangers) together with VRF CITY MULTI WY and WR2 systems, heat may be extracted from the ground to warm in winter, and dissipated into the ground to cool in summer.



Key Technologies

									
---	---	---	---	---	---	--	---	--	--

Technical specifications WY LINE

MODEL Single			PQHY-P200YLM-A1	PQHY-P250YLM-A1	PQHY-P300YLM-A1
HP			8	10	12
Power supply	Phases/Voltage/Freq.	V/Hz/n°	3-phase 380-400-415V 50Hz		
Cooling	Capacity*1	kW	22.4	28.0	33.5
	Power input	kW	3.71	4.90	6.04
	EER		6.03	5.71	5.54
	SEER		8.12	8.16	7.42
	Temperature operating field	Indoor WB °C Water °C	15.0~24.0 10.0~45.0	15.0~24.0 10.0~45.0	15.0~24.0 10.0~45.0
Heating	Capacity*2	kW	25.0	31.5	37.5
	Power input	kW	3.97	5.08	6.25
	COP		6.29	6.20	6.00
	SCOP		4.90	4.61	4.55
	Temperature operating field	Indoor DB °C Water °C	15.0~27.0 10.0~45.0	15.0~27.0 10.0~45.0	15.0~27.0 10.0~45.0
Sound power level*3		dB(A)	46	48	54
Connectable indoor units	Total capacity		50 to 130% of O.U. capacity	50 to 130% of O.U. capacity	50 to 130% of O.U. capacity
	Model/Quantity		P15~P250/1~17	P15~P250/1~21	P15~P250/1~26
Ø Ref. piping	Liquid	mm	9.52	9.52	9.52
	Gas		19.05	22.2	22.2
Circulating Water	Flow rate	m³/h	5.76	5.76	5.76
	Operating volume range		3.0~7.2	3.0~7.2	3.0~7.2
	Pressure drop	kPa	24	24	24
	Heat exchanger volume	l	5	5.0	5.0
External dimensions		mm	1100 x 880 x 550	1100 x 880 x 550	1100 x 880 x 550
Net weight		kg	174	174	174
Ref. Charge R410**/CO ₂ Eq		kg/Tons	5.0 / 10.44	5.0 / 10.44	5.0 / 10.44

*1 Nominal cooling conditions: Indoor: 27°C DB / 19°C WB. Water temperature 30°C. Piping length 7.5 m, vertical difference 0 m.

*2 Nominal heating conditions: Indoor 20°C DB. Water temperature 20°C. Piping length 7.5 m, vertical difference 0 m.

*3 Values measured in anechoic chamber.

** GWP value of HFC R410A 2088 according to 517 / 2014.

Technical specifications WY LINE

MODEL Single			PQHY-P350YLM-A1	PQHY-P400YLM-A1	PQHY-P450YLM-A1	PQHY-P500YLM-A1	PQHY-P550YLM-A1	PQHY-P600YLM-A1
HP			14	16	18	20	22	24
Power supply	Phases/Voltage/Freq.	V/Hz/n°	3-phase 380-400-415V 50Hz					
Cooling	Capacity*1	kW	40.0	45.0	50.0	56.0	63.0	69.0
	Power input	kW	7.14	8.03	9.29	11.17	12.54	14.49
	EER		5.60	5.60	5.38	5.01	5.02	4.76
	SEER		7.44	7.40	6.62	6.30	6.89	6.89
	Temperature operating field	Indoor WB °C Water °C	15.0~24.0 10.0~45.0	15.0~24.0 10.0~45.0	15.0~24.0 10.0~45.0	15.0~24.0 10.0~45.0	15.0~24.0 10.0~45.0	15.0~24.0 10.0~45.0
Heating	Capacity*2	kW	45.0	50.0	56	63.0	69.0	76.5
	Power input	kW	7.53	8.37	9.79	11.43	12.27	14.51
	COP		5.97	5.97	5.72	5.51	5.62	5.27
	SCOP		4.29	4.25	4.17	4.04	3.77	3.51
	Temperature operating field	Indoor DB °C Water °C	15.0~27.0 10.0~45.0	15.0~27.0 10.0~45.0	15.0~27.0 10.0~45.0	15.0~27.0 10.0~45.0	15.0~27.0 10.0~45.0	15.0~27.0 10.0~45.0
Sound power level*3		dB(A)	52	52	54	54	56.5	56.5
Connectable indoor units	Total capacity		50 to 130% of O.U. capacity	50 to 130% of O.U. capacity	50 to 130% of O.U. capacity	50 to 130% of O.U. capacity	50 to 130% of O.U. capacity	50 to 130% of O.U. capacity
	Model/Quantity		P15~P250/1~30	P15~P250/1~34	P15~P250/1~39	P15~P250/1~43	P15~P250/2~47	P15~P250/2~50
Ø Ref. piping	Liquid	mm	12.7	15.88	15.88	15.88	15.88	15.88
	Gas		28.58	28.58	28.58	28.58	28.58	28.58
Circulating Water	Flow rate	m³/h	7.20	7.20	7.20	7.20	11.52	11.52
	Operating volume range		4.5~11.6	4.5~11.6	4.5~11.6	4.5~11.6	6.0~14.4	6.0~14.4
	Pressure drop	kPa	44	44	44	44	45	45
	Heat exchanger volume	l	5.0	5.0	5.0	5.0	5.0	5.0
External dimensions		mm	1450 x 880 x 550	1450 x 880 x 550	1450 x 880 x 550	1450 x 880 x 550	1450 x 880 x 550	1450 x 880 x 550
Net weight		kg	217	217	217	217	246	246
Ref. Charge R410**/CO ₂ Eq		kg/Tons	6.0 / 12.53	6.0 / 12.53	6.0 / 12.53	6.0 / 12.53	11.7 / 24.43	11.7 / 24.43

Technical specifications WY LINE

MODEL Double			PQHY-P400YSLM-A1	PQHY-P450YSLM-A1	PQHY-P500YSLM-A1	PQHY-P550YSLM-A1	PQHY-P600YSLM-A1
HP			16	18	20	22	24
Modules			PQHY-P200YLM-A PQHY-P200YLM-A	PQHY-P250YLM-A PQHY-P200YLM-A	PQHY-P250YLM-A PQHY-P250YLM-A	PQHY-P300YLM-A PQHY-P250YLM-A	PQHY-P300YLM-A PQHY-P300YLM-A
Twinning joint			CMY-Y100VBK3				
Power supply	Phases/Voltage/Freq.	V/Hz/n°	3 phase 380-400-415V 50Hz				
Cooling	Capacity*1	kW	45.0	50.0	56.0	63.0	69.0
	Power input	kW	7.70	8.78	10.12	11.55	12.84
	EER		5.84	5.69	5.53	5.45	5.37
	SEER		-	-	-	-	-
	Temperature operating field	Indoor WB	°C	15.0~24.0	15.0~24.0	15.0~24.0	15.0~24.0
Water		°C	10.0~45.0	10.0~45.0	10.0~45.0	10.0~45.0	10.0~45.0
Heating	Capacity*2	kW	50.0	56.0	63.0	69.0	76.5
	Power input	kW	7.94	8.97	10.16	11.31	12.75
	COP		6.29	6.24	6.20	6.10	6.0
	SCOP		-	-	-	-	-
	Temperature operating field	Indoor DB	°C	15.0~27.0	15.0~27.0	15.0~27.0	15.0~27.0
Water		°C	10.0~45.0	10.0~45.0	10.0~45.0	10.0~45.0	10.0~45.0
Sound power level*3			49	50	51	55	57
Connectable indoor units	Total capacity		50 to 130% of O.U. capacity	50 to 130% of O.U. capacity	50 to 130% of O.U. capacity	50 to 130% of O.U. capacity	50 to 130% of O.U. capacity
	Model/Quantity		P15~P250/1~34	P15~P250/1~39	P15~P250/1~43	P15~P250/2~47	P15~P250/2~50
Ø Ref. piping	Liquid/Gas	mm	15.88/28.58	15.88/28.58	15.88/28.58	15.88/28.58	15.88/28.58
	Flow rate	m³/h	5.76+5.76	5.76+5.76	5.76+5.76	5.76+5.76	5.76+5.76
Circulating Water	Operating volume range		3+3~7.2+7.2	3+3~7.2+7.2	3+3~7.2+7.2	3+3~7.2+7.2	3+3~7.2+7.2
	Pressure drop	kPa	24+24	24+24	24+24	24+24	24+24
	Heat exchanger volume	l	5.0+5.0	5.0+5.0	5.0+5.0	5.0+5.0	5.0+5.0
	External dimentions	mm	1100 x 880 x 550 1100 x 880 x 550	1100 x 880 x 550 1100 x 880 x 550	1100 x 880 x 550 1100 x 880 x 550	1100 x 880 x 550 1100 x 880 x 550	1100 x 880 x 550 1100 x 880 x 550
Net weight	kg	174+174	174+174	174+174	174+174	174+174	
Ref. Charge R410**/CO ₂ Eq	kg/Tons	5.0+5.0/20.88	5.0+5.0/20.88	5.0+5.0/20.88	5.0+5.0/20.88	5.0+5.0/20.88	

*1 Nominal cooling conditions: Indoor: 27°C DB / 19°C WB. Water temperature 30°C. Piping length 7.5 m, vertical difference 0 m.

*2 Nominal heating conditions: Indoor 20°C DB. Water temperature 20°C. Piping length 7.5 m, vertical difference 0 m.

*3 Values measured in anechoic chamber.

** GWP value of HFC R410A 2088 according to 517 / 2014.

Technical specifications WY LINE

MODEL Double			PQHY-P700YSLM-A1	PQHY-P750YSLM-A1	PQHY-P800YSLM-A1	PQHY-P850YSLM-A1	PQHY-P900YSLM-A1
HP			28	30	32	34	36
Modules			PQHY-P350YLM-A PQHY-P350YLM-A	PQHY-P400YLM-A PQHY-P350YLM-A	PQHY-P400YLM-A PQHY-P400YLM-A	PQHY-P450YLM-A PQHY-P400YLM-A	PQHY-P450YLM-A PQHY-P450YLM-A
Twinning joint			CMY-Y200VBK2				
Power supply	Phases/Voltage/Freq.	V/Hz/n°	3 phase 380-400-415V 50Hz				
Cooling	Capacity*1	kW	80.0	85.0	90.0	96.0	101.0
	Power input	kW	14.73	15.64	16.57	18.03	19.38
	EER		5.43	5.43	5.43	5.32	5.21
	SEER		-	-	-	-	-
	Temperature operating field	Indoor WB	°C	15.0~24.0	15.0~24.0	15.0~24.0	15.0~24.0
Water		°C	10.0~45.0	10.0~45.0	10.0~45.0	10.0~45.0	10.0~45.0
Heating	Capacity*2	kW	50.0	56.0	63.0	69.0	76.5
	Power input	kW	7.94	8.97	10.16	11.31	12.75
	COP		6.29	6.24	6.20	6.10	6.0
	SCOP		-	-	-	-	-
	Temperature operating field	Indoor DB	°C	15.0~27.0	15.0~27.0	15.0~27.0	15.0~27.0
Water		°C	10.0~45.0	10.0~45.0	10.0~45.0	10.0~45.0	10.0~45.0
Sound power level*3			55	55	55	56	57
Connectable indoor units	Total capacity		50 to 130% of O.U. capacity	50 to 130% of O.U. capacity	50 to 130% of O.U. capacity	50 to 130% of O.U. capacity	50 to 130% of O.U. capacity
	Model/Quantity		P15~P250/2~50	P15~P250/2~50	P15~P250/2~50	P15~P250/2~50	P15~P250/2~50
Ø Ref. piping	Liquid/Gas	mm	19.05/34.93	19.05/34.93	19.05/34.93	19.05/41.28	19.05/41.28
	Flow Rate	m³/h	7.20+7.20	7.20+7.20	7.20+7.20	7.20+7.20	7.20+7.20
Circulating Water	Operating volume range		4.5+4.5~11.6+11.6	4.5+4.5~11.6+11.6	4.5+4.5~11.6+11.6	4.5+4.5~11.6+11.6	4.5+4.5~11.6+11.6
	Pressure drop	kPa	44+44	44+44	44+44	44+44	44+44
	Heat exchanger volume	l	5.0+5.0	5.0+5.0	5.0+5.0	5.0+5.0	5.0+5.0
	External dimentions	mm	1450 x 880 x 550 1450 x 880 x 550	1450 x 880 x 550 1450 x 880 x 550	1450 x 880 x 550 1450 x 880 x 550	1450 x 880 x 550 1450 x 880 x 550	1450 x 880 x 550 1450 x 880 x 550
Net weight	kg	217+217	217+217	217+217	217+217	217+217	
Ref. Charge R410**/CO ₂ Eq	kg/Tons	6.0+6.0/25.06	6.0+6.0/25.06	6.0+6.0/25.06	6.0+6.0/25.06	6.0+6.0/25.06	

*1 Nominal cooling conditions: Indoor: 27°C DB / 19°C WB. Water temperature 30°C. Piping length 7.5 m, vertical difference 0 m.

*2 Nominal heating conditions: Indoor 20°C DB. Water temperature 20°C. Piping length 7.5 m, vertical difference 0 m.

*3 Values measured in anechoic chamber.

** GWP value of HFC R410A 2088 according to 517 / 2014.

Technical specifications WR2 LINE

MODEL Single			PQRY-P200YLM-A1	PQRY-P250YLM-A1	PQRY-P300YLM-A1
HP			8	10	12
Power supply	Phases/Voltage/Freq.	V/Hz/n°	3 phase 380-400-415V 50Hz		
Cooling	Capacity*1	kW	22.4	28.0	33.5
	Power input	kW	3.71	4.90	6.04
	EER		6.03	5.71	5.54
	SEER		7.91	7.99	7.30
	Temperature operating field	Indoor WB	°C	15.0~24.0	15.0~24.0
Water		°C	10.0~45.0	10.0~45.0	10.0~45.0
Heating	Capacity*2	kW	25.0	31.5	37.5
	Power input	kW	3.97	5.08	6.25
	COP		6.29	6.20	6.00
	SCOP		4.90	4.61	4.55
	Temperature operating field	Indoor DB	°C	15.0~27.0	15.0~27.0
Water		°C	10.0~45.0	10.0~45.0	10.0~45.0
Sound power level*3			46	48	54
Connectable indoor units	Total capacity	50 to 150% of O.U. capacity			50 to 150% of O.U. capacity
	Model/Quantity	P15~P250/1~20			P15~P250/1~25
Ø Ref. piping	Liquid	mm	15.88	19.05	19.05
	Gas	mm	19.05	22.2	22.2
Circulating Water	Flow Rate	m³/h	5.76	5.76	5.76
	Operating volume range		3.0~7.2	3.0~7.2	3.0~7.2
	Pressure drop	kPa	24	24	24
	Heat exchanger volume	l	5.0	5.0	5.0
External dimention			1100 x 880 x 550	1100 x 880 x 550	1100 x 880 x 550
Net weight			172	172	172
Ref. Charge R410**/CO ₂ Eq			5.0 /10.44	5.0 /10.44	5.0 /10.44

*1 Nominal cooling conditions: Indoor: 27°C DB / 19°C WB. Water temperature 30°C. Piping length 7.5 m, vertical difference 0 m.

*2 Nominal heating conditions: Indoor 20°C DB. Water temperature 20°C. Piping length 7.5 m, vertical difference 0 m.

*3 Values measured in anechoic chamber.

** GWP value of HFC R410A 2088 according to 517 / 2014.

Technical specifications WR2 LINE

MODEL Single			PQRY-P350YLM-A1	PQRY-P400YLM-A1	PQRY-P450YLM-A1	PQRY-P500YLM-A1	PQRY-P550YLM-A1	PQRY-P600YLM-A1
HP			14	16	18	20	22	24
Power supply	Phases/Voltage/Freq.	V/Hz/n°	3 phase 380-400-415V 50Hz					
Cooling	Capacity*1	kW	40.0	45.0	50.0	56.0	63.0	69.0
	Power input	kW	7.14	8.03	9.29	11.17	12.54	14.49
	EER		5.60	5.60	5.38	5.01	5.02	4.76
	SEER		7.34	7.31	6.56	6.25	6.84	6.84
	Temperature operating field	Indoor WB	°C	15.0~24.0	15.0~24.0	15.0~24.0	15.0~24.0	15.0~24.0
Water		°C	10.0~45.0	10.0~45.0	10.0~45.0	10.0~45.0	10.0~45.0	10.0~45.0
Heating	Capacity*2	kW	45.0	50.0	56.0	63.0	69.0	76.5
	Power input	kW	7.53	8.37	9.79	11.43	12.27	14.51
	COP		5.97	5.97	5.72	5.51	5.62	5.27
	SCOP		4.29	4.25	4.17	4.04	3.77	3.51
	Temperature operating field	Indoor DB	°C	15.0~27.0	15.0~27.0	15.0~27.0	15.0~27.0	15.0~27.0
Water		°C	10.0~45.0	10.0~45.0	10.0~45.0	10.0~45.0	10.0~45.0	10.0~45.0
Sound power level*3			52	52	54	54	56.5	56.5
Connectable indoor units	Total capacity	50 to 150% of O.U. capacity						
	Model/Quantity	P15~P250/1~35		P15~P250/1~40	P15~P250/1~45	P15~P250/1~50	P15~P250/2~50	P15~P250/2~50
Ø Ref. piping	Liquid	mm	22.2	22.2	22.2	22.2	22.2	22.2
	Gas	mm	28.58	28.58	28.58	28.58	28.58	34.93
Circulating Water	Flow Rate	m³/h	7.20	7.20	7.20	7.20	11.52	11.52
	Operating volume range		4.5~11.6	4.5~11.6	4.5~11.6	4.5~11.6	6.0~14.4	6.0~14.4
	Pressure drop	kPa	44	44	44	44	45	45
	Heat exchanger volume	l	5	5	5	5	10	10
External dimention			1450 x 880 x 550	1450 x 880 x 550	1450 x 880 x 550	1450 x 880 x 550	1450 x 880 x 550	1450 x 880 x 550
Net weight			216	216	216	216	246	246
Ref. Charge R410**/CO ₂ Eq			6.0 /12.53	6.0 /12.53	6.0 /12.53	6.0 /12.53	11.7/24.43	11.7/24.43

*1 Nominal cooling conditions: Indoor: 27°C DB / 19°C WB. Water temperature 30°C. Piping length 7.5 m, vertical difference 0 m.

*2 Nominal heating conditions: Indoor 20°C DB. Water temperature 20°C. Piping length 7.5 m, vertical difference 0 m.

*3 Values measured in anechoic chamber.

** GWP value of HFC R410A 2088 according to 517 / 2014

Technical specifications WR2 LINE

MODEL Double			PQRY-P400YSLM-A1	PQRY-P450YSLM-A1	PQRY-P500YSLM-A1	PQRY-P550YSLM-A1	PQRY-P600YSLM-A1
HP			16	18	20	22	24
Modules			PQRY-P200YLM-A PQRY-P200YLM-A	PQRY-P250YLM-A PQRY-P200YLM-A	PQRY-P250YLM-A PQRY-P250YLM-A	PQRY-P300YLM-A PQRY-P250YLM-A	PQRY-P300YLM-A PQRY-P300YLM-A
Twinning joint			CMY-Q100VBK				
Power supply	Phases/Voltage/Freq.	V/Hz/n°	3-phase 380-400-415V 50Hz				
Cooling	Capacity*1	kW	45.0	50.0	56.0	63.0	69.0
	Power input	kW	7.70	8.78	10.12	11.55	12.84
	EER		5.84	5.69	5.53	5.45	5.37
	SEER		-	-	-	-	-
	Temperature operating field	Indoor WB Water	°C	15.0~24.0 10.0~45.0	15.0~24.0 10.0~45.0	15.0~24.0 10.0~45.0	15.0~24.0 10.0~45.0
Heating	Capacity*2	kW	50.0	56.0	63.0	69.0	76.5
	Power input	kW	7.94	8.97	10.16	11.31	12.75
	COP		6.29	6.24	6.20	6.10	6.00
	SCOP		-	-	-	-	-
	Temperature operating field	Indoor DB Water	°C	15.0~27.0 10.0~45.0	15.0~27.0 10.0~45.0	15.0~27.0 10.0~45.0	15.0~27.0 10.0~45.0
Sound power level*3			49	50	51	55	57
Connectable indoor units	Total capacity	50 to 150% of O.U. capacity					
	Model/Quantity	P15-P250/1~40		P15-P250/1~45	P15-P250/1~50	P15-P250/1~50	P15-P250/2~50
Ø Ref. piping	Liquid/Gas	mm	22.2/28.58	22.2/28.58	22.2/28.58	22.2/28.58	22.2/34.93
Circulating Water	Flow Rate	m³/h	5.76 + 5.76	5.76 + 5.76	5.76 + 5.76	5.76 + 5.76	5.76 + 5.76
	Operating volume range		3+3 ~ 7.2+7.2	3+3 ~ 7.2+7.2	3+3 ~ 7.2+7.2	3+3 ~ 7.2+7.2	3+3 ~ 7.2+7.2
	Pressure drop	kPa	24 + 24	24 + 24	24 + 24	24 + 24	24 + 24
	Heat exchanger volume	l	5.0 + 5.0	5.0 + 5.0	5.0 + 5.0	5.0 + 5.0	5.0 + 5.0
External dimensions			1100 x 880 x 550 1100 x 880 x 550	1100 x 880 x 550 1100 x 880 x 550	1100 x 880 x 550 1100 x 880 x 550	1100 x 880 x 550 1100 x 880 x 550	1100 x 880 x 550 1100 x 880 x 550
Net weight			172+172	172+172	172+172	172+172	172+172
Ref. Charge R410**/CO ₂ Eq			5.0+5.0 /20.88	5.0+5.0 /20.88	5.0+5.0 /20.88	5.0+5.0 /20.88	5.0+5.0 /20.88

Technical specifications WR2 LINE

MODEL Double			PQRY-P700YSLM-A1	PQRY-P750YSLM-A1	PQRY-P800YSLM-A1	PQRY-P850YSLM-A1	PQRY-P900YSLM-A1
HP			28	30	32	34	36
Modules			PQRY-P350YLM-A PQRY-P350YLM-A	PQRY-P400YLM-A PQRY-P350YLM-A	PQRY-P400YLM-A PQRY-P400YLM-A	PQRY-P450YLM-A PQRY-P400YLM-A	PQRY-P450YLM-A PQRY-P450YLM-A
Twinning joint			CMY-Q100VBK				
Power supply	Phases/Voltage/Freq.	V/Hz/n°	3-phase 380-400-415V 50Hz				
Cooling	Capacity*1	kW	80.0	85.0	90.0	96.0	101.0
	Power input	kW	14.73	15.64	16.57	18.03	19.38
	EER		5.43	5.43	5.43	5.32	5.21
	SEER		-	-	-	-	-
	Temperature operating field	Indoor WB Water	°C	15.0~24.0 10.0~45.0	15.0~24.0 10.0~45.0	15.0~24.0 10.0~45.0	15.0~24.0 10.0~45.0
Heating	Capacity*2	kW	88	95.0	100.0	108.0	113.0
	Power input	kW	14.73	15.90	16.75	18.49	19.74
	COP		5.97	5.97	5.97	5.84	5.72
	SCOP		-	-	-	-	-
	Temperature operating field	Indoor DB Water	°C	15.0~27.0 10.0~45.0	15.0~27.0 10.0~45.0	15.0~27.0 10.0~45.0	15.0~27.0 10.0~45.0
Sound power level*3			55	55	55	56	57
Connectable indoor units	Total capacity	50 to 150% of O.U. capacity					
	Model/Quantity	P15-P250/2~50		P15-P250/2~50	P15-P250/2~50	P15-P250/2~50	P15-P250/2~50
Ø Ref. piping	Liquid/Gas	mm	28.58/34.93	28.58/34.93	28.58/34.93	28.58/41.28	28.58/41.28
Circulating Water	Flow Rate	m³/h	7.20 + 7.20	7.20 + 7.20	7.20 + 7.20	7.20 + 7.20	7.20 + 7.20
	Operating volume range		4.5+4.5 ~ 11.6+11.6	4.5+4.5 ~ 11.6+11.6	4.5+4.5 ~ 11.6+11.6	4.5+4.5 ~ 11.6+11.6	4.5+4.5 ~ 11.6+11.6
	Pressure drop	kPa	44 + 44	44 + 44	44 + 44	44 + 44	44 + 44
	Heat exchanger volume	l	5.0 + 5.0	5.0 + 5.0	5.0 + 5.0	5.0 + 5.0	5.0 + 5.0
External dimensions			1450 x 880 x 550 1450 x 880 x 550	1450 x 880 x 550 1450 x 880 x 550	1450 x 880 x 550 1450 x 880 x 550	1450 x 880 x 550 1450 x 880 x 550	1450 x 880 x 550 1450 x 880 x 550
Net weight			216 + 216	216 + 216	216 + 216	216 + 216	216 + 216
Ref. Charge R410**/CO ₂ Eq			6.0+6.0 /25.06	6.0 + 6.0 /25.06	6.0 + 6.0 /25.06	6.0 + 6.0 /25.06	6.0 + 6.0 /25.06

*1 Nominal cooling conditions: Indoor: 27°C DB / 19°C WB. Water temperature 30°C. Piping length 7.5 m, vertical difference 0 m.

*2 Nominal heating conditions: Indoor 20°C DB. Water temperature 20°C. Piping length 7.5 m, vertical difference 0 m.

*3 Values measured in anechoic chamber.

*4 GWP value of HFC R410A 2088 according to 517 / 2014



BC CONTROLLERS FOR R2 LINES

CMB-M V-J1/V-JA1/V-KB1, CMB-P V-KA1

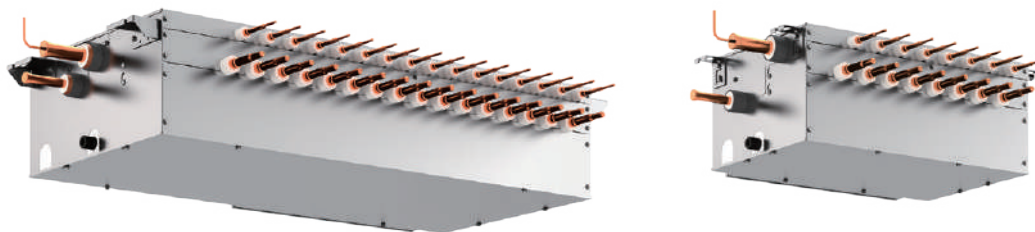

BC Distributors

The new BC distributor of the CMB-P(M)-V-J(1) series effectively distributes the refrigerant depending on the operating mode of the indoor units (heating or cooling). It contains the highly efficient gas/liquid separator developed by Mitsubishi Electric and carefully separates the gas for heating from the cooling liquid. For a greater height difference and an increase in the maximum pipe length, it uses a subcooling heat exchanger that further chills the coolant destined for the indoor units in cooling mode.

Reduced height

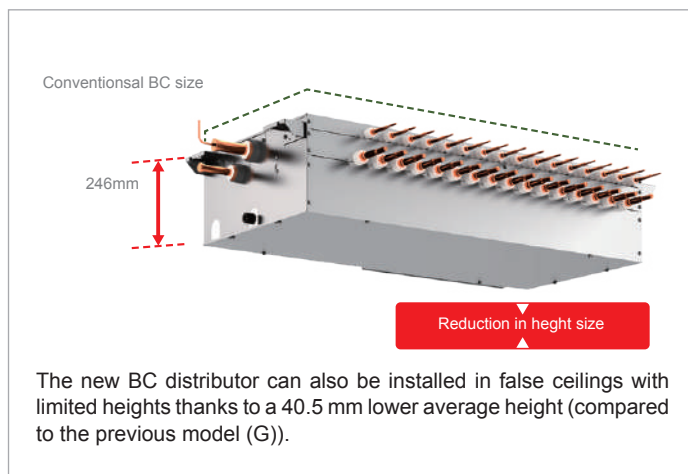

New BC controller

Increased number of connections (for systems with BC SUB distributor) and increase of geometric limits. In the R2 heat recovery systems of the new YNW-A1 line it is possible to connect up to 11 BC SUB distributors to the BC MAIN distributor thus allowing greater configuration flexibility. The adoption of the new architecture allows a reduction of the refrigerant charge adopted in the system.

SYSTEM LAYOUT R2

PREVIOUS MODEL (G)

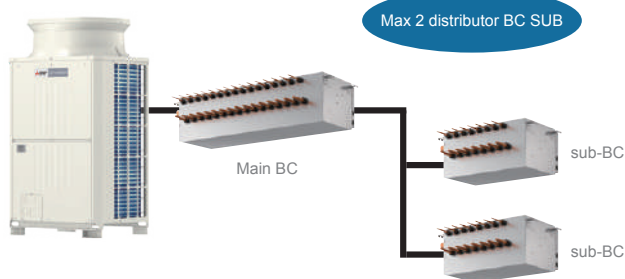

NEXT STAGE J (1)

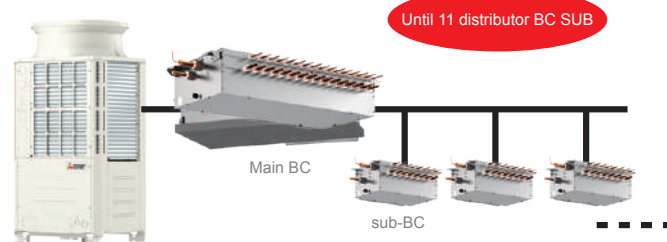

Greater flexibility in system configuration

The maximum length of the refrigeration line between the BC MAIN distributor unit and the indoor unit has been increased to 90 metres* (compared to 60 metres for the previous model) for greater flexibility of system design.

*If the indoor unit is connected to an SUB BC Controller unit

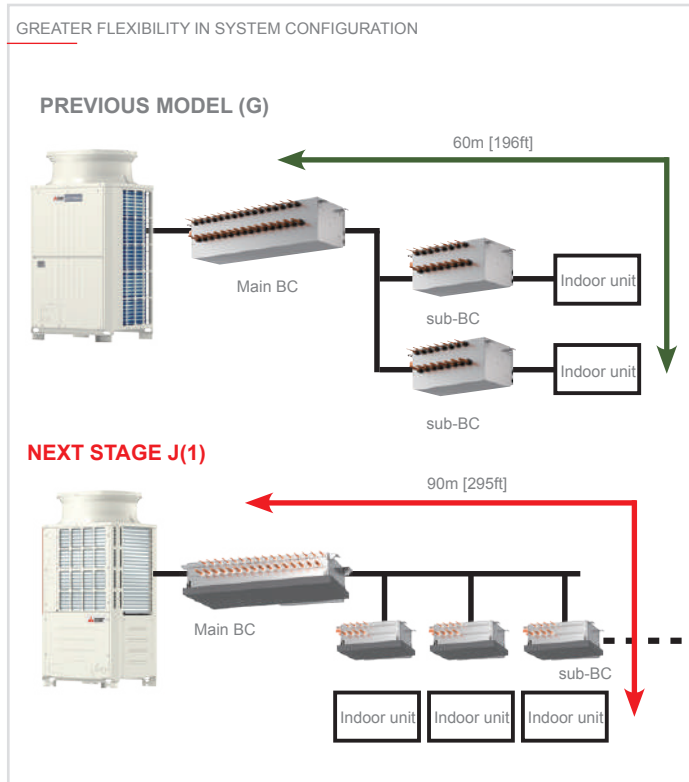

Greater accessibility and ease of maintenance

In the previous model, the drainage panel was on the lower side of the distributor. In the new model it is instead installed on the lower side of the structure, making it easy to remove from the lower part for maintenance access.

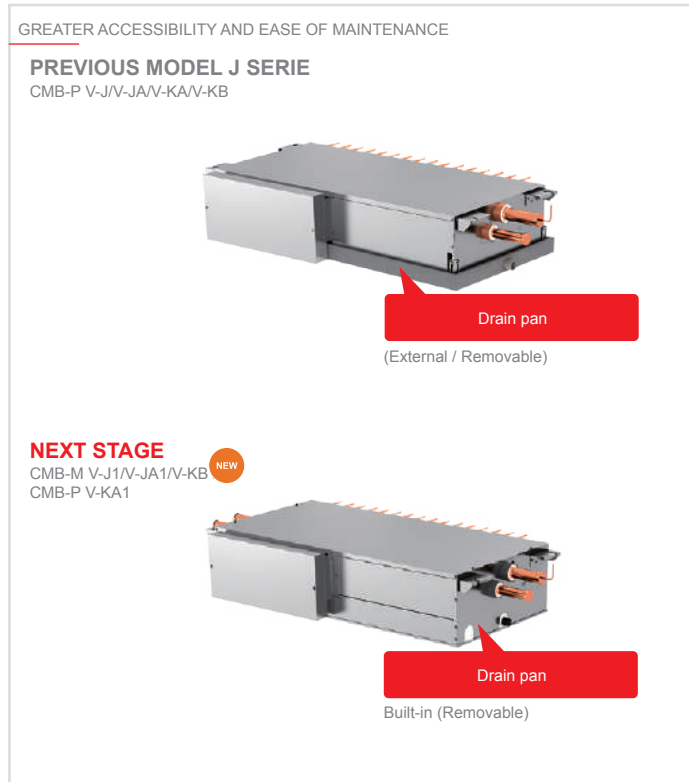

Sub-BC controller connections increased

Only two sub-BC controllers could be connected to a main BC controller in previous models. Up to 11 sub-BC controllers can now be connected to the new BC controller, allowing for more flexibility in system design. The line-branching method enables the creation of system designs that use less refrigerant.

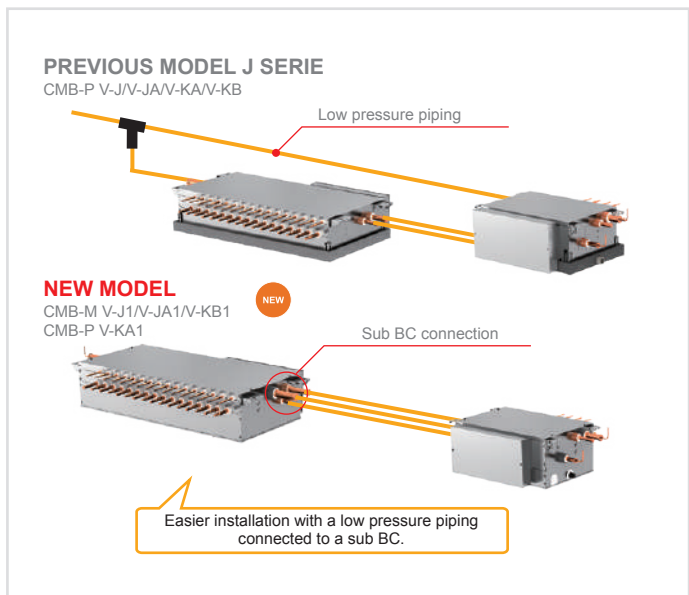

The line-branching method with a main BC controller and sub-BC controllers

The sub-BC controller can be installed near the indoor units, so the branch piping can be greatly reduced. This also reduces the length of system piping, enabling using less refrigerant design.

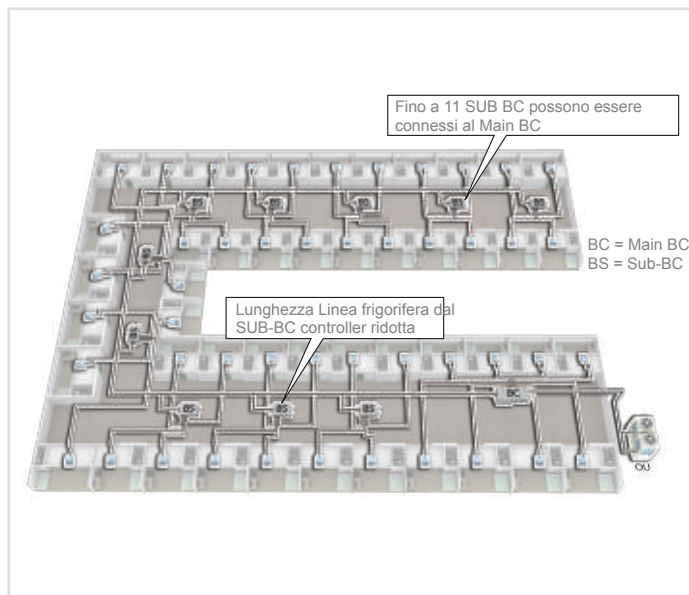

Technical specifications

MODEL Single				CMB-M104V-J1	CMB-M106V-J1	CMB-M108V-J1	CMB-M1012V-J1	CMB-M1016V-J1	
Number of branch				4	6	8	12	16	
Power source				1-phase 220-230-240 V					
Power input	kW	50Hz	Cooling	0.067/0.076/0.085	0.097/0.110/0.123	0.127/0.144/0.161	0.186/0.211/0.236	0.246/0.279/0.312	
			Heating	0.030/0.034/0.038	0.045/0.051/0.057	0.060/0.068/0.076	0.090/0.102/0.114	0.119/0.135/0.151	
Indoor unit capacity connectable to 1 branch				Model P80 or smaller (Use optional joint pipe combing 2 branches when the total unit capacity exceeds P81.)					
Connectable outdoor/heat source unit capacity				P200 to P350					
Height	mm			250	250	250	252	252	
Width	mm			596	596	596	911	1,135	
Depth	mm			476	476	476	622	622	
Refrigerant piping diameter	To outdoor/heat source unit			Connectable unit capacity					
				P200		P250/P300		P350	
	High press. pipe			15.88 (5/8) Brazed		19.05 (3/4) Brazed		19.05 (3/4) Brazed or 22.2 (7/8) Brazed	
	Low press. pipe			19.05 (3/4) Brazed		22.2 (7/8) Brazed		28.58 (1-1/8) Brazed	
	To indoor unit	Liquid pipe			Indoor unit Model 50 or smaller 6.35 (1/4) Brazed bigger than 50 9.52 (3/8) Brazed				
Gas pipe			Indoor unit Model 50 or smaller 12.7 (1/2) Brazed bigger than 50 15.88 (5/8) Brazed (19.05 (3/4), 22.2(7/8) with optional joint pipe used.)						
Drain pipe	mm (in.)			O.D. 32 (1-1/4)	O.D. 32 (1-1/4)	O.D. 32 (1-1/4)	O.D. 32 (1-1/4)	O.D. 32 (1-1/4)	
Net weight	kg (lbs)			26 (58)	29 (64)	33 (73)	49 (109)	59 (131)	

Technical specifications

MODEL Main				CMB-M108V-JA1			CMB-M1012V-JA1			CMB-M1016V-JA1			
Number of branch				8			12			16			
Power source				1-phase 220-230-240 V									
Power input	kW	50Hz	Cooling	0.127/0.144/0.161			0.186/0.211/0.236			0.246/0.279/0.312			
			Heating	0.060/0.068/0.076			0.090/0.102/0.114			0.119/0.135/0.151			
Indoor unit capacity connectable to 1 branch				Model P80 or smaller (Use optional joint pipe combing 2 branches when the total unit capacity exceeds P81.)									
Connectable outdoor/heat source unit capacity				P200 to P900									
Height	mm			252			252			252			
Width	mm			911			1,135			1,135			
Depth	mm			622			622			622			
Refrigerant piping diameter	To outdoor/heat source unit			Connectable unit capacity									
				P200	P250/P300	P350	P400 to P500	P550	P600	P650	P700 to P800	P850 to P900	
	High press. pipe			15.88 (5/8) Brazed	19.05 (3/4) Brazed	19.05 (3/4) Brazed or 22.2 (7/8) Brazed	22.2 (7/8) Brazed	22.2 (7/8) Brazed or 28.58 (1-1/8) Brazed	22.2 (7/8) Brazed or 28.58 (1-1/8) Brazed	28.58 (1-1/8) Brazed	28.58 (1-1/8) Brazed	28.58 (1-1/8) Brazed	
	Low press. pipe			19.05 (3/4) Brazed	22.2 (7/8) Brazed	28.58 (1-1/8) Brazed	28.58 (1-1/8) Brazed	28.58 (1-1/8) Brazed	28.58 (1-1/8) Brazed or 34.93 (1-3/8) Brazed	28.58 (1-1/8) Brazed	34.93 (1-3/8) Brazed	41.28 (1-5/8) Brazed	
	To indoor unit	Liquid pipe			Indoor unit Model 50 or smaller 6.35 (1/4) Brazed bigger than 50 9.52 (3/8) Brazed								
		Gas pipe			Indoor unit Model 50 or smaller 12.7 (1/2) Brazed bigger than 50 15.88 (5/8) Brazed (19.05 (3/4), 22.2 (7/8) with optional joint pipe used.)								
	To other BC controller			Total down-stream Indoor unit capacity									
				to P200	P201 to P300	P301 to P350	P351 to P400	P401 to P600	P601 to P650	P651 to P800	P801 to P1000	P1001 or above	
	High press. pipe			15.88 (5/8) Brazed	19.05 (3/4) Brazed	19.05 (3/4) Brazed	22.2 (7/8) Brazed	22.2 (7/8) Brazed	28.58 (1-1/8) Brazed	28.58 (1-1/8) Brazed	28.58 (1-1/8) Brazed	34.93 (1-3/8) Brazed	
	Low press. pipe			19.05 (3/4) Brazed	22.2 (7/8) Brazed	28.58 (1-1/8) Brazed	28.58 (1-1/8) Brazed	28.58 (1-1/8) Brazed	28.58 (1-1/8) Brazed	34.93 (1-3/8) Brazed	41.28 (1-5/8) Brazed	41.28 (1-5/8) Brazed	
Liquid pipe			9.52 (3/8) Brazed	9.52 (3/8) Brazed	12.7 (1/2) Brazed	12.7 (1/2) Brazed	15.88 (5/8) Brazed	15.88 (5/8) Brazed	19.05 (3/4) Brazed	19.05 (3/4) Brazed	19.05 (3/4) Brazed		
Drain pipe	mm (in.)			O.D. 32 (1-1/4)			O.D. 32 (1-1/4)			O.D. 32 (1-1/4)			
Net weight	kg (lbs)			48 (106)			60 (133)			68 (150)			

★ Combination chart of BC Controller for R2 series (YNW)

	P200-P350	P400-P900	P950-P1100
CMB-M V-J1	•	N/A	N/A
CMB-M V-JA1	•	•	N/A
CMB-P V-KA1	•	•	•
CMB-M V-KB1 (Sub)	CMB-M108/1012/1016V-JA1, CMB-P1016V-KA1		

Technical specifications

MODEL Main				CMB-P1016V-KA1								
Number of branch				16								
Power source				1-phase 220-230-240 V								
Power input	kW	50Hz	Cooling	0.246/0.279/0.312								
			Heating	0.119/0.135/0.151								
Indoor unit capacity connectable to 1 branch				Model P80 or smaller (Use optional joint pipe combing 2 branches when the total unit capacity exceeds P81.)								
The maximum number of connectable Sub BC controllers				-								
The maximum connectable capacity of indoor units				-								
Connectable outdoor/heat source unit capacity				P200 to P1100								
Connectable Main BC controller				-								
Height	mm			250								
Width	mm			1,135								
Depth	mm			622								
Refrigerant piping diameter	To outdoor/heat source unit			Connectable unit capacity								
				P200	P250/P300	P350	P400 to P500	P550	P600	P650	P700 to P800	P850 to P1000
	High press. pipe			15.88 (5/8) Braze	19.05 (3/4) Braze	19.05 (3/4) Braze or 22.2 (7/8) Braze	22.2 (7/8) Braze	22.2 (7/8) Braze or 28.58 (1-1/8) Braze	22.2 (7/8) Braze or 28.58 (1-1/8) Braze	28.58 (1-1/8) Braze	28.58 (1-1/8) Braze	28.58 (1-1/8) Braze
	Low press. pipe			19.05 (3/4) Braze	22.2 (7/8) Braze	28.58 (1-1/8) Braze	28.58 (1-1/8) Braze	28.58 (1-1/8) Braze	28.58 (1-1/8) Braze or 34.93 (1-3/8) Braze	28.58 (1-1/8) Braze	34.93 (1-3/8) Braze	41.28(1-5/8) Braze
	To indoor unit	Liquid pipe			Indoor unit Model 50 or smaller 6.35 (1/4) Braze bigger than 50 9.52 (3/8) Braze							
		Gas pipe			Indoor unit Model 50 or smaller 12.7 (1/2) Braze bigger than 50 15.88 (5/8) Braze (19.05 (3/4), 22.2 (7/8) with optional joint pipe used.)							
	To other BC controller			Total down-stream Indoor unit capacity								
				to P200	P201 to P300	P301 to P350	P351 to P400	P401 to P600	P601 to P650	P651 to P800	P801 to P1000	P1001 or above
	High press. pipe			15.88 (5/8) Braze	19.05 (3/4) Braze	19.05 (3/4) Braze	22.2 (7/8) Braze	22.2 (7/8) Braze	28.58 (1-1/8) Braze	28.58 (1-1/8) Braze	28.58 (1-1/8) Braze	34.93 (1-3/8) Braze
	Low press. pipe			19.05 (3/4) Braze	22.2 (7/8) Braze	28.58 (1-1/8) Braze	28.58 (1-1/8) Braze	28.58 (1-1/8) Braze	28.58 (1-1/8) Braze	34.93 (1-3/8) Braze	41.28(1-5/8) Braze	41.28(1-5/8) Braze
Liquid pipe			9.52 (3/8) Braze	9.52 (3/8) Braze	12.7 (1/2) Braze	12.7 (1/2) Braze	15.88 (5/8) Braze	15.88 (5/8) Braze	19.05 (3/4) Braze	19.05 (3/4) Braze	19.05 (3/4) Braze	
Drain pipe	mm (in.)			O.D. 32 (1-1/4)								
Net weight	kg (lbs)			69 (153)								

Technical specifications

MODEL Sub				CMB-M104V-KB1										
Number of branch				4										
Power source				1-phase 220-230-240 V										
Power input	kW	50Hz	Cooling	0.060/0.068/0.076										
			Heating	0.030/0.034/0.038										
The maximum number of connectable Sub BC controllers				11										
The maximum connectable capacity of indoor units				P350 for each										
Connectable Main BC controller				CMB-M108/1012/1016V-JA1, CMB-P1016V-KA1										
Height	mm			250										
Width	mm			596										
Depth	mm			476										
Refrigerant piping diameter	To outdoor/heat source unit			-										
	High press. pipe			-										
	Low press. pipe			-										
	To indoor unit	Liquid pipe			Indoor unit Model 50 or smaller 6.35 (1/4) Brazed bigger than 50 9.52 (3/8) Brazed									
		Gas pipe			Indoor unit Model 50 or smaller 12.7 (1/2) Brazed bigger than 50 15.88 (5/8) Brazed (19.05 (3/4) with optional joint pipe used.)									
	To other BC controller			Total down-stream Indoor unit capacity										
				to P200	P201 to P300	P301 to P350	P351 to P400	P401 to P600	P601 to P650	P651 to P800	P801 to P1000	P1001 or above		
	High press. pipe			15.88 (5/8) Brazed	19.05 (3/4) Brazed	19.05 (3/4) Brazed	22.2 (7/8) Brazed	22.2 (7/8) Brazed	28.58 (1-1/8) Brazed	28.58 (1-1/8) Brazed	28.58 (1-1/8) Brazed	34.93 (1-3/8) Brazed		
	Low press. pipe			19.05 (3/4) Brazed	22.2 (7/8) Brazed	28.58 (1-1/8) Brazed	28.58 (1-1/8) Brazed	28.58 (1-1/8) Brazed	28.58 (1-1/8) Brazed	34.93 (1-3/8) Brazed	41.28(1-5/8) Brazed	41.28(1-5/8) Brazed		
	Liquid pipe			9.52 (3/8) Brazed	9.52 (3/8) Brazed	12.7 (1/2) Brazed	12.7 (1/2) Brazed	15.88 (5/8) Brazed	15.88 (5/8) Brazed	19.05 (3/4) Brazed	19.05 (3/4) Brazed	19.05 (3/4) Brazed		
Drain pipe	mm (in.)			O.D. 32 (1-1/4)										
Net weight	kg (lbs)			23 (51)										

Technical specifications

MODEL Sub				CMB-M108V-KB1										
Number of branch				8										
Power source				1-phase 220-230-240 V										
Power input	kW	50Hz	Cooling	0.119/0.135/0.151										
			Heating	0.060/0.068/0.076										
The maximum number of connectable Sub BC controllers				11										
The maximum connectable capacity of indoor units				P350 for each										
Connectable Main BC controller				CMB-M108/1012/1016V-JA1, CMB-P1016V-KA1										
Height	mm			246										
Width	mm			596										
Depth	mm			495										
Refrigerant piping diameter	To outdoor/heat source unit			-										
	High press. pipe			-										
	Low press. pipe			-										
	To indoor unit	Liquid pipe			Indoor unit Model 50 or smaller 6.35 (1/4) Brazed bigger than 50 9.52 (3/8) Brazed									
		Gas pipe			Gas pipe Indoor unit Model 50 or smaller 12.7 (1/2) Brazed bigger than 50 15.88 (5/8) Brazed(19.05 (3/4) with optional joint pipe used.)									
	To other BC controller			Total down-stream Indoor unit capacity										
				to P200	P201 to P300	P301 to P350	P351 to P400	P401 to P600	P601 to P650	P651 to P800	P801 to P1000	P1001 or above		
	High press. pipe			15.88	19.05	19.05	22.2	22.2	28.58	28.58	28.58	34.93		
	Low press. pipe			19.05	22.2	28.58	28.58	28.58	28.58	34.93	41.28	41.28		
	Liquid pipe			9.52	9.52	12.7	12.7	15.88	15.88	19.05	19.05	19.05		
Drain pipe	mm (in.)			O.D. 32 (1-1/4)										
Net weight	kg (lbs)			31 (69)										



WCB WATER-REFRIGERANT CONNECTION BOX

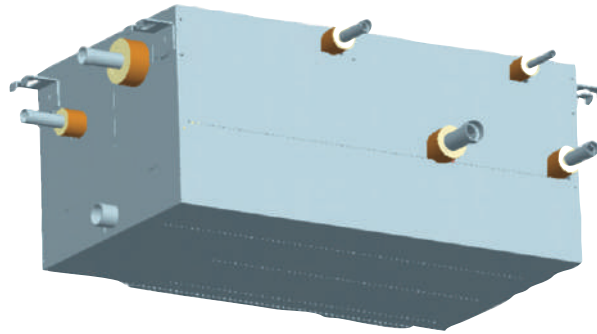

CMB-PW202V-J



WCB refrigerant – water connection box

The WCB refrigerant-water connection box is effectively a simplified BC controller. The WCB has 2 branches only (standard indoor units / PWFY) and is specifically intended to permit air cooling functionality via the 'indoor unit' branch and domestic and heating hot water production functionality via the 'PWFY' branch. While the WCB does not permit simultaneous heating and cooling operation of the indoor units connected to the 'indoor unit' branch, it does allow heat recovery in summer between the two branches, for practically free domestic hot water production.

The WCB water connection box may be used to feed a mixed R2 system (HWS and ATW hydronic modules in combination with standard indoor units), allowing the following scenarios:

	ATW	HWS	Indoor Units
	Primary heating with underfloor system	Domestic hot water production	Air cooling or heating
Winner	ON	ON	OFF
Autumn / Spring	OFF	ON	ON
Summer	OFF	ON	ON

Technical specifications

MODEL			CMB-PW202V-J
Number of branches			2
Power	Voltage/Freq./Phases	V/Hz/n°	1 phase 220-230-240V 50 Hz/60Hz
Power absorption		kW	0.020
External finish			Galvanized
Capacity of connectable indoor unit		Total	50~130% of outdoor unit capacity
Indoor unit branch			Up to 130% of outdoor unit capacity
PWFY branch			Up to 100% of outdoor unit capacity
Connectable outdoor units			PURY-(E)P200/250/300YNW / PQRY-P200/250/300YLM
Dimensions (HxLxW)		mm	284 x 648 x 432
Drain pipe			28.58 brazed
Net weight		kg	20

			CONNECTIONS			
Refrigerant pipe diameter	To outdoor unit		See capacity of connectable outdoor unit			
			P200		P250-P300	
		High press. pipe.	15.88		19.05	
	Low press. pipe.	19.05		22.2		
	To indoor unit		See total capacity of subsequent indoor units			
			~ P140	P141~P200	P201~P300	P301~
Liquid pipe		ø9.52 brazed	ø9.52 brazed	ø9.52 brazed	ø15.88 brazed	
Gas pipe	ø15.88 brazed	ø19.05 brazed	ø22.2 brazed	ø28.58 brazed		



Model code

CITY MULTI outdoor units

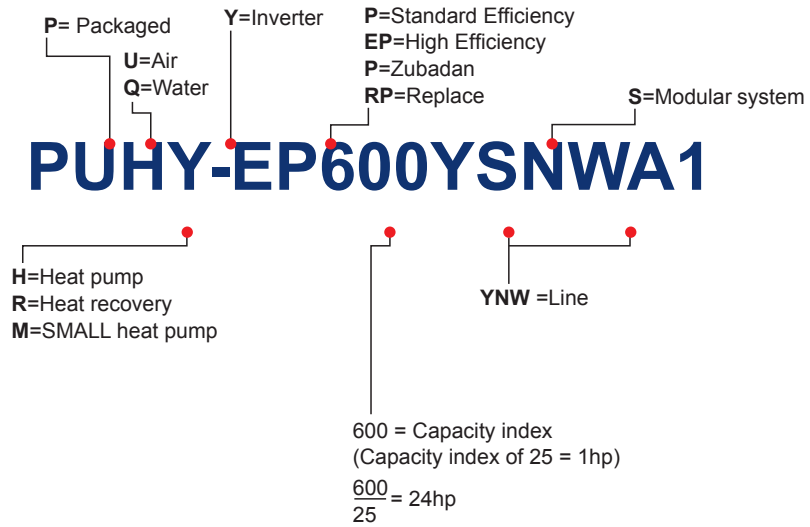

CITY MULTI indoor units

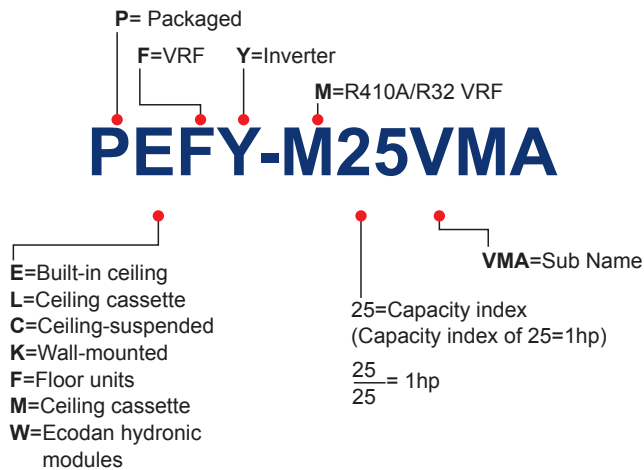

BC Controller

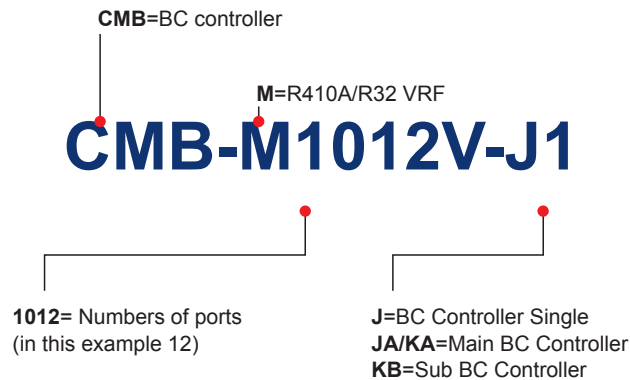



Refrigerant piping lenght

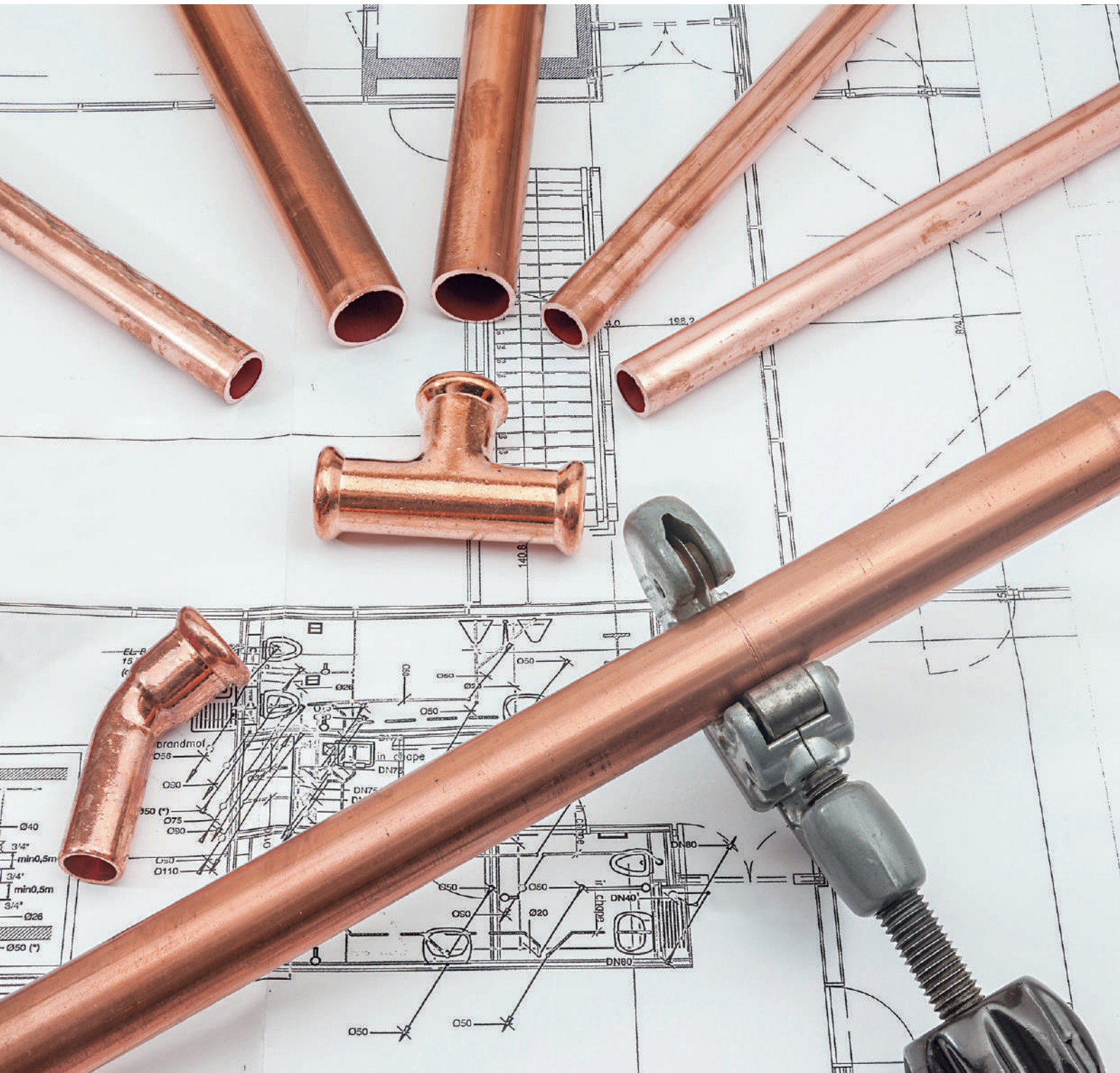

PUMY-SP112~140 Y(V)KM

SMALL Y COMPACT LINE

GEOMETRIC LIMITS OF REFRIGERATION PIPELINES	
Total effective length	120 m max.
Effective length of a single circuit	70 m max.
Effective length after first branch	50 m max.

VERTICAL DIFFERENCE BETWEEN UNITS	
Indoor/outdoor (outdoor unit in higher position)	50 m max.
Indoor/outdoor (indoor unit in higher position)	30 m max.
Indoor/Indoor	15 m max.

Indicative values only – See technical handbook for installation details.

*1 Use optional deflectors if the outdoor unit is installed in a location subject to high winds.

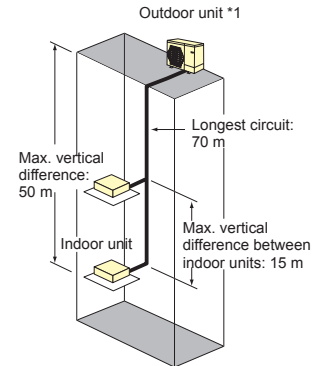

PUMY-P112~140 Y(V)KM4(5)

SMALL Y LINE

GEOMETRIC LIMITS OF REFRIGERATION PIPELINES	
Total effective length	300 m max.
Effective length of a single circuit	150 m max.
Effective length after first branch	30 m max.

VERTICAL DIFFERENCE BETWEEN UNITS	
Indoor/outdoor (outdoor unit in higher position)	50 m max.
Indoor/outdoor (indoor unit in higher position)	40 m max.
Indoor/Indoor	15 m max.

Indicative values only – See technical handbook for installation details.

*1 Use optional deflectors if the outdoor unit is installed in a location subject to high winds.

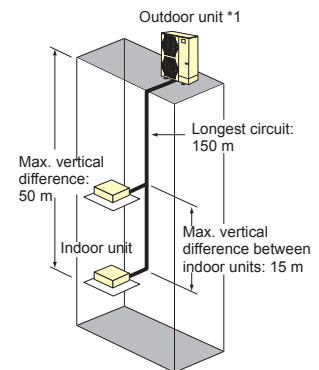

PUMY-P200 YKM2

SMALL Y (HIGH CAPACITY) LINE

GEOMETRIC LIMITS OF REFRIGERATION PIPELINES	
Total effective length	150 m max.
Effective length of a single circuit	80 m max.
Effective length after first branch	30 m max.

VERTICAL DIFFERENCE BETWEEN UNITS	
Indoor/outdoor (outdoor unit in higher position)	50 m max.
Indoor/outdoor (indoor unit in higher position)	40 m max.
Indoor/Indoor	15 m max.

Indicative values only – See technical handbook for installation details.

*1 Use optional deflectors if the outdoor unit is installed in a location subject to high winds.

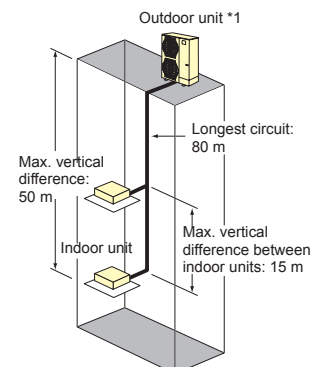

PUMY-P250/300 YBM

SMALL Y (HIGH CAPACITY) LINE

GEOMETRIC LIMITS OF REFRIGERATION PIPELINES	
Total effective length	310 m max.
Effective length of a single circuit	150 m max.
Effective length after first branch	30 m max.

VERTICAL DIFFERENCE BETWEEN UNITS	
Indoor/outdoor (outdoor unit in higher position)	50 m max.
Indoor/outdoor (indoor unit in higher position)	40 m max.
Indoor/Indoor	15 m max.

Indicative values only – See technical handbook for installation details.

*1 Use optional deflectors if the outdoor unit is installed in a location subject to high winds.

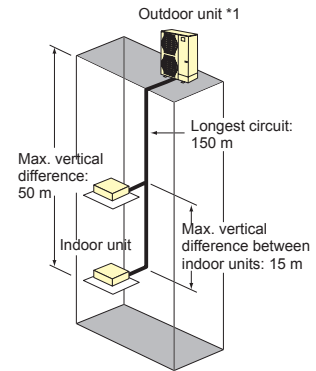

PUHY-P200-1500Y(S)KA

Y ECOSTANDARD LINE

GEOMETRIC PIPING LIMITATIONS WITH ONE OR MORE BC CONTROLLERS	
Total effective length	1000 m max.
Effective length of a single circuit	165 m max.
Equivalent length of a single circuit	190 m max.
Effective length after first branch	90 m max.
Effective length between outdoor unit	10 m max.

VERTICAL DIFFERENCE BETWEEN UNITS	
Indoor/outdoor (outdoor unit in higher position)	50 m max.
Indoor/outdoor (indoor unit in higher position)	40 m max.
Indoor/Indoor	30 m max.

Indicative values only – See technical handbook for installation details.

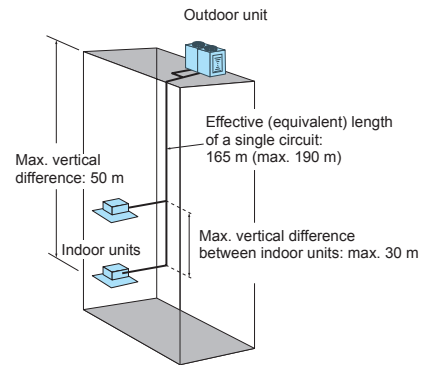

PUHY-P200-1350Y(S)NW-A1

PUHY-EP200-1350Y(S)NW-A1

Y NEXT STAGE LINE

Y NEXT STAGE HIGH EFFICIENCY LINE

GEOMETRIC PIPING LIMITATIONS WITH ONE OR MORE BC CONTROLLERS	
Total effective length	1000 m max.
Effective length of a single circuit	165 m max.
Equivalent length of a single circuit	190 m max.
Effective length after first branch	90 m max.

VERTICAL DIFFERENCE BETWEEN UNITS	
Indoor/outdoor (outdoor unit in higher position)	50 m max.
Indoor/outdoor (indoor unit in higher position)	40 m max.
Indoor/Indoor	30 m max.

Indicative values only – See technical handbook for installation details.

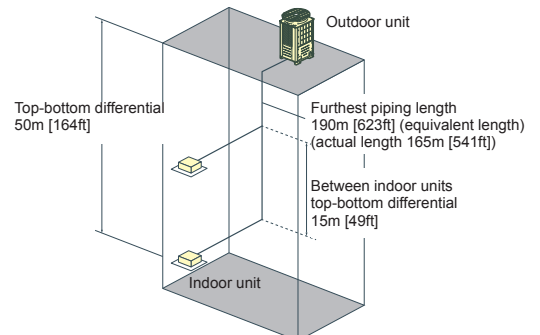

PURY-P200-1100Y(S)NW-A1

PURY-EP200-1100Y(S)NW-A1

R2 NEXT STAGE LINE
R2 NEXT STAGE HIGH EFFICIENCY LINE

GEOMETRIC PIPING LIMITATIONS WITH ONE OR MORE BC CONTROLLERS	
Total effective length	500-1000 m max.
Effective length of a single circuit	165 m max.
Equivalent length of a single circuit	190 m max.
Effective length between outdoor unit and BC controller	110 m max.
Effective length between BC controller and indoor unit	60 m max.

VERTICAL DIFFERENCE BETWEEN UNITS	
Indoor/outdoor (outdoor unit in higher position)	50 m max.
Indoor/outdoor (indoor unit in higher position)	40 m max.
Indoor/BC Controller	15 m max.
Indoor/Indoor	30 m max.
Effective length between outdoor unit and BC controller	15 m max.

Indicative values only – See technical handbook for installation details.

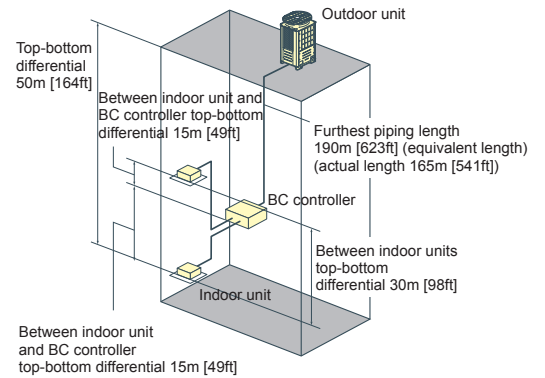

PQHY-P200-900Y(S)LM-A1

WY LINE

GEOMETRIC LIMITS OF REFRIGERATION PIPELINES	
Total effective length	300-500 m max.
Effective length of a single circuit	165 m max.
Equivalent length of a single circuit	190 m max.
Effective length after first branch	40 m max.

VERTICAL DIFFERENCE BETWEEN UNITS	
Indoor/outdoor (outdoor unit in higher position)	50 m max.
Indoor/outdoor (indoor unit in higher position)	40 m max.
Indoor/Indoor	15 m max.

Indicative values only – See technical handbook for installation details.
*500 m max per PQHY-P350-600YLM

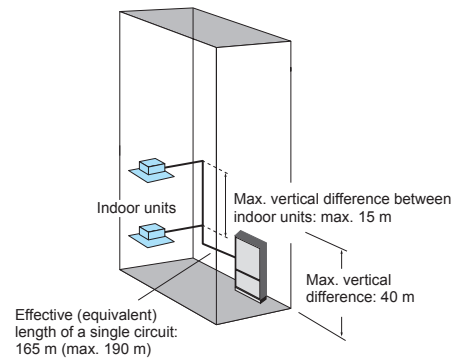

PQRY-P200~900Y(S)LM-A1

WR2 LINE

GEOMETRIC PIPING LIMITATIONS WITH ONE OR MORE BC CONTROLLERS	
Total effective length	300-750 m max.
Effective length of a single circuit	165 m max.
Equivalent length of a single circuit	190 m max.
Effective length between outdoor unit and BC controller	110 m max.
Effective length between BC controller and indoor unit	40-60 m max.

VERTICAL DIFFERENCE BETWEEN UNITS	
Indoor/outdoor (outdoor unit in higher position)	50 m max.
Indoor/outdoor (indoor unit in higher position)	40 m max.
Indoor/BC Controller	15 m max.
Indoor/Indoor	30 m max.
BC Controller and SUB BC Controller	15 m max.

Indicative values only – See technical handbook for installation details.

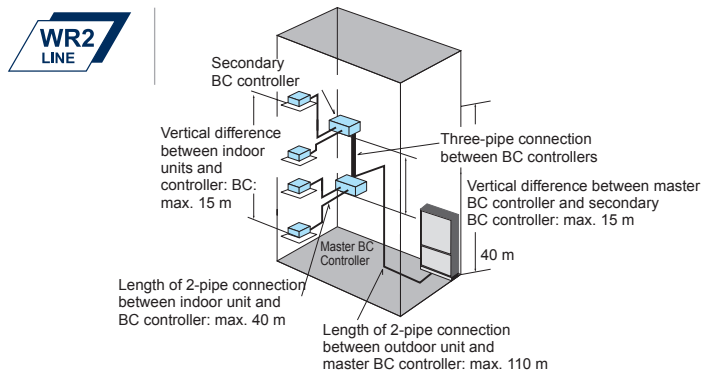



VRF Systems

Indoor units

Ceiling cassette

PLFY-P VFM-E1 4-way cassette 600x600	110
PLFY-M VEM-E 4 way cassette 900x900	112
PLFY-P VLMD-E 2 way cassette	116
PMFY-P VBM-E 1 way cassette	120

Ceiling concealed

PEFY-P VMS1-E Medium to low static pressure	122
PEFY-M VMA-A Medium to high static pressure	124
PEFY-P VMHS-E High static pressure	128
PEFY-P VMHS-E High static pressure	130

Ceiling suspended

PCFY-P VKM-E	132
--------------	-----

Wall mounted

PKFY-P VLM-E	134
PKFY-P VKM-E	136
PAC-LV11-E Wall mounted design indoor unit LEV-KIT	138



Floor standing

PFFY-P VKM-E Design unit	140
PFFY-P VLEM-E Exposed	142
PFFY-P VCM-E Concealed type	144

Type		Model		P10	P15	P20	P25	P32		
				1.2 kW ¹	1.7 kW ¹	2.2 kW ¹	2.8 kW ¹	3.6 kW ¹		
Ceiling cassette	4 way flow	PLFY-P VFM-E1			•	•	•	•		
		PLFY-M VEM-E				•	•	•		
	2 way cassette	PLFY-P VLMD-E				•	•	•		
	1 way cassette	PMFY-P VBM-E				•	•	•		
Ceiling concealed indoor units	Middle-high static pressure	PEFY-P VMS1-E			•	•	•	•		
	Middle-high static pressure	PEFY-M VMA-A				•	•	•		
	High static pressure	PEFY-P VMHS-E								
	High static pressure	PEFY-P VMHS-E								
Ceiling Suspended indoor units		PCFY-P VKM-E								
Wall mounted indoor units		PKFY-P VLM		•	•	•	•	•		
		PKFY-P VKM								
	Wall mounted design with LEV-KIT	LEV KIT MSZ-EF			•	•	•	•	•	
		LEV KIT MSZ-LN					•	•	•	
Floor standing indoor units		PFFY-P VKM-E				•	•	•		
		PFFY-P VLEM-E				•	•	•		
	Concealed type	PFFY-P VCM-E				•	•	•		

*Nominal cooling capacity

	P40	P50	P63	P71	P80	P100	P125	P140	P200	P250
	4.5 kW ⁻¹	5.6 kW ⁻¹	7.1 kW ⁻¹	8.0 kW ⁻¹	9.0 kW ⁻¹	11.2 kW ⁻¹	14.0 kW ⁻¹	16.0 kW ⁻¹	22.4 kW ⁻¹	28.0 kW ⁻¹
	.	.								
			
			
	.									
	.	.								
		
									.	.
			
	.	.								
			.			.				
	.	.								
		.								
	.									
	.	.	.							
	.	.	.							



Key Technologies

Mitsubishi Electric innovation allowed the development of functions and technologies at the service of comfort and energy efficiency.

Style



“Pure white” colour

This is the colour adopted by Mitsubishi Electric for many of its indoor units. It is a colour suitable for virtually all interior spaces.



Automatic vane

The vane adjusts automatically to the optimum angle in relation to operating mode and output air temperature.

Functions



Timer

Annual, weekly, daily or simplified timer functions may be used to switch the unit on and off as desired.

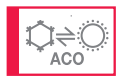

Automatic mode switching

The indoor unit automatically (AUTO) switches operating mode (COOL/HEAT) in relation to the temperature setting.



Ultra silent

These indoor units produce extraordinarily low sound pressure levels.

Air quality



Deodorizing filter

The bad smells present in the environment are captured from the deodorizing filter and then be eliminated by the technology plasma. Extremely low deodorization time makes this function even more effective against the odors of animals or of cooking.



Outdoor air intake

The air quality in the indoor space may be improved using the outdoor fresh air intake.

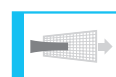

Standard filter

A honeycomb or synthetic fibre filter with high dust holding capacity.



Long-life filter

The special surface of the long-life filter requires less maintenance than a conventional filter.



“Dirty filters” indicator signal

Filter usage is monitored to indicate when maintenance is necessary.



Air purifying filter

The filter has a large capture area and deodorise the circulating air.

Air distribution



Vane positions

Number of possible positions for the air deflector vane.



Swing vane

A continuous swinging motion of the vane ensures that air is distributed ideally throughout the room.



Fan speed

Number of fan speeds available.



Automatic fan

La velocità del ventilatore viene regolata in automatico per soddisfare il grado di comfort richiesto.



High ceiling

For installations on high ceilings, the air flow may be augmented to improve air distribution.



Low ceiling

For installations on low ceilings, the air flow may be reduced to prevent unpleasant draughts.



Air intake on underside

As an option during installation, the unit may be configured with the air intake on the underside.

Installation and maintenance



Condensate drain pump

The condensate drain pump facilitates installation.



Self-diagnostic

A self-diagnostic system makes troubleshooting and correcting malfunctions easier by recording a log of faults.

Special functions



Auto-restart

The auto restart function may be used to configure the indoor units to restart automatically after a power outage, minimising interruptions in the operation of the system to maintain thermal comfort levels in the air conditioned spaces. This function must be enabled as an option as it is not enabled by default. A choice of two automatic start configurations is available:

- restart only the indoor units which were on before the power outage;
- restart all indoor units, irrespective of on/off state before the power outage.



Stratification compensation

The automatic heat stratification compensation function in HEAT mode is implemented by adjusting the ambient temperature read by a probe on the indoor unit, to obtain a value that more closely reflects the true temperature of the air conditioned space.

An offset of -4°C is applied, so that, for instance, if the inlet temperature measured is 24°C, the system automatically displays an adjusted value of 20°C, which should more closely reflect the true ambient temperature. The Mitsubishi Electric CITY MULTI VRF system bases the thermal power actually delivered on this value.

The stratification compensation function is available on all Mitsubishi Electric indoor unit types with the exception of floor-standing units and certain specific cases (such as with units with underside air intakes), and may be disabled on request.

































Low temperature cooling









This function extends the operating temperature range in cooling mode to offer a lowest settable temperature of 14°C. Where the ability to cool to temperatures lower than the standard lowest comfort value of 19°C (typically for sports centres, laboratories etc.) is necessary, the settable temperature range in cooling mode may be extended to offer a lowest temperature of 14°C.

Contact your local distributor for more details on the types of compatible Indoor units.

The indoor unit fan is run at a higher speed in this configuration (except with the SMALL Y model outdoor unit of the PUMY series).

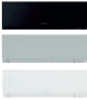
		Cassette						
								
		PLFY-P VFM-E1	PLFY-M VEM-E	PLFY-P VLMD-E	PMFY-P VBM-E	PEFY-P VMS1-E	PEFY-M VMA-A	PEFY-P VMHS-E
Style		•	•	•	•			
		•	•	•	•			
Functions		•	•		•	•	•	•
		•	•	•	•	•	•	•
		•	•	•		•		
Air quality		•	•	•				
		•	•	•				
								
		•	•	•	•			
								
								
								
Air distribution		5	5	4	4			
		•	•	•	•			
		3	4	3 4(P125)	4	3	3	2
		•	•			•		
		•	•					
		•	•					
							•	
Install. and mainten.		•	•	•	•	•*	•	•*
		•	•	•	•	•	•	•
Special functions		•	•	•	•	•	•	•
		•	•		•	•	•	•
				•		•	•	•

* Optional

							Floor standing	
								
PEFY-P VMHS-E	PCFY-P VKM-E	PKFY-P VKM-E	PKFY-P VLM	LEV KIT MSZ-EF	LEV KIT MSZ-LN	PFFY-P VLEM-E	PFFY-P VCM-E	
	.	.	.					
			
.	
.	
	.			.	.			
		
	.							
	
					.			
	5	4	5	5	5			
			
3	4	2	4	5	5	2	3	
.	.			.	.			
	.							
	.							
.								
.								
.								
.						.	.	
.								
.								
.								
.						.	.	

PLFY-P VFM-E1

INDOOR UNITS - 4-way cassette 600x600



CITY MULTI

Ideal for...

The **straight-line shape** introduced has resulted in a stylish and modern square design. Its high affinity ensures the ability to blend in seamlessly with any interior. The indoor unit is an ideal match for office or store use.



3D i-see Sensor

New advanced 3D i-see sensor detects people's position and number. Once a person is detected, the angle of the vane is automatically adjusted. Each vane can be independently set to "Direct Airflow" or "Indirect Airflow" according to taste.

The 3D i-see Sensor detects the number of people in the room and adjusts the power accordingly. This makes automatic power-saving operation possible in places where the number of people changes frequently.

Additionally, when the area is continuously unoccupied, the system switches to a more enhanced power-saving mode. Depending on the setting, it can also stop the operation.

Horizontal flow

The new airflow control completely eliminates that uncomfortable drafty-feeling with the introduction of a **horizontal airflow** that spreads across the ceiling, maximizing the Coanda effect. Furthermore, 5 patterns for vane position (on previous VCM was 4) and individual settable vane and ways ensure higher comfort. The ideal airflow for offices and restaurants.

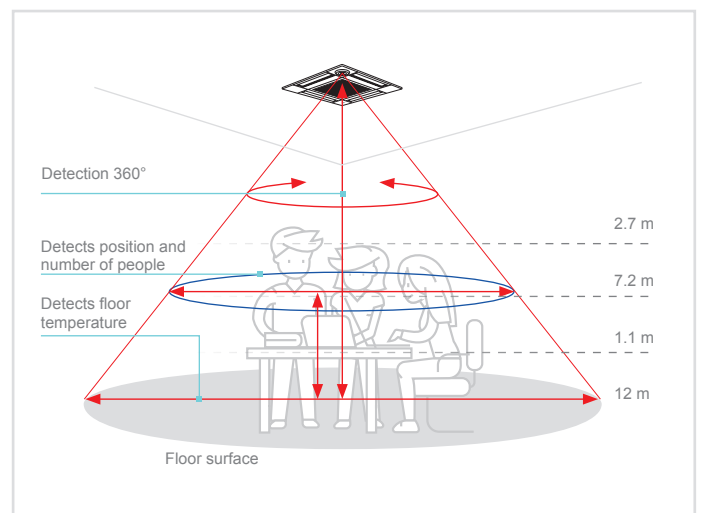
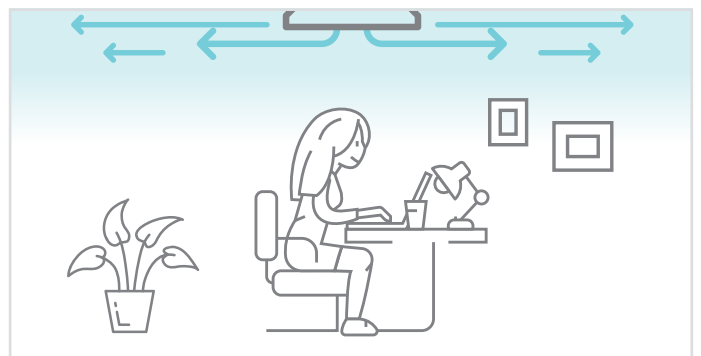

Simplified installation

The height above ceiling of 245 mm is top class in the industry. The height above ceiling of 245 mm enables fitting into narrow ceiling space. Installation is simple, even when the ceiling spaces are narrow to make the ceilings higher. Light weight (max 15kg) and temporary hanging hooks for grille allow to make installation easier and quicker.

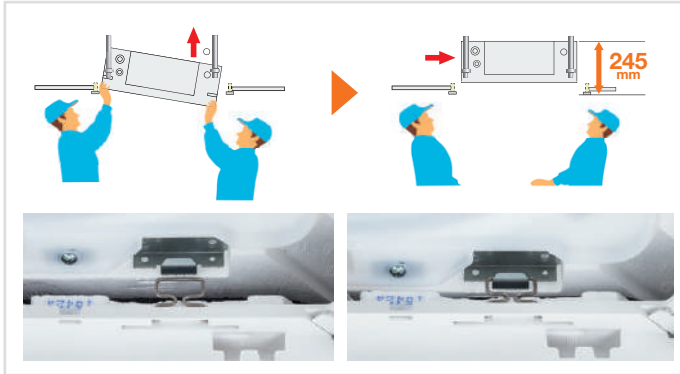

Panel and control

The unit is supplied with SLP-2FAL panel which includes signal receiver. Is available as optional the SLP-2FALM panel combined with the new PAR-SL101A-E wireless remote control with weekly timer, backlight, temperature setting in 0.5 °C steps and individual control of the 4 deflectors.

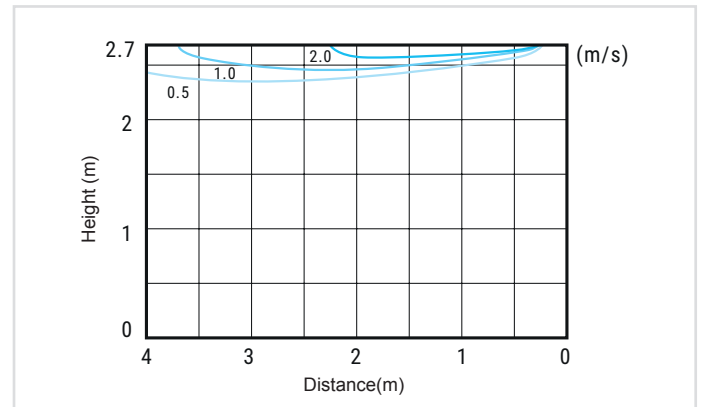

Key Technologies

Technical specifications

MODEL			PLFY-P15VFM-E1	PLFY-P20VFM-E1	PLFY-P25VFM-E1	PLFY-P32VFM-E1	PLFY-P40VFM-E1	PLFY-P50VFM-E1	
Default panel			SLP-2FAL						
Power			Single phase, 220-240V 50Hz						
Capacity in cooling mode*1		kW	1.7	2.2	2.8	3.6	4.5	5.6	
		Btu/h	5800	7500	9600	12300	15400	19100	
Capacity in heating mode*1		kW	1.9	2.5	3.2	4	5	6.3	
		Btu/h	6500	8500	10900	13600	17100	21500	
Power consumption	Cooling	kW	0.02	0.02	0.02	0.02	0.03	0.04	
	Heating	kW	0.02	0.02	0.02	0.02	0.03	0.04	
Current	Cooling	A	0.19	0.21	0.22	0.23	0.28	0.4	
	Heating	A	0.14	0.16	0.17	0.18	0.23	0.35	
External finish	Unit		Galvanised steel sheet with uncoated thermal insulation						
	Grille		Pure White						
Dimensions A x L x P	Unit	mm	245x570x570	245x570x570	245x570x570	245x570x570	245x570x570	245x570x570	
	Grille	mm	10x625x625	10x625x625	10x625x625	10x625x625	10x625x625	10x625x625	
Net weight	Unit	kg	14	14	14	15	15	15	
	Grille	kg	3	3	3	3	3	3	
Heat exchanger			Cross fins						
Fan	Type x Quantity		3D Turbo fan x 1						
	Air flow*2	m³/min	6.5 - 7.5 - 8	6.5 - 7.5 - 8.5	6.5 - 8 - 9	7 - 8 - 9.5	7.5 - 9 - 11	9 - 11 - 13	
	Ext. Static pressure	Pa	0	0	0	0	0	0	
Air filter			Polypropylen honeycomb (long life)						
Refrigerant pipe diameter	Gas (swaged)	mm	12.7	12.7	12.7	12.7	12.7	12.7	
	Liquid (swaged)	mm	6.35	6.35	6.35	6.35	6.35	6.35	
Sound pressure*2*3			dB(A)	26 - 28 - 30	26 - 29 - 31	26 - 30 - 33	26 - 30 - 34	28 - 33 - 39	33 - 39 - 43

* Default panel. SLP-2FAL panel is equipped by Signal receiver

*1 For heating/cooling capacity, the maximum value with the unit operating in the following conditions is given.

Cooling: indoor 27°C (81°F) DB/19°C (66°F) WB, outdoor 35°C (95°F) DB. Heating: indoor 20°C (68°F) DB, outdoor 7°C (45°F) DB/6°C (43°F) WB.

*2 Air flow/noise levels given for operation in low-medium-high modes.

*3 Measured in anechoic chamber with 230V mains power.

Optional parts	DESCRIPTION
PAC-SF1ME-E	Corner 3D I-see Sensor for PLFY-P VFM-E1

PLFY-M VEM-E

INDOOR UNITS - 4-way cassette 900x900



CITY MULTI

Ideal for...

New design of 4-way cassette VEM model suits most commercial applications thanks to its elegance and style. Its peculiar features are horizontal flow function, individually settable vanes and possibility to install 3D i-see sensor for top environment comfort control.

3D i-see sensor: Temperature sensor

3D i-see sensor is able to detect temperature distribution inside the room, making it possible to direct airflow to those areas which generally receive less air, making them more uncomfortable (too cold or too hot) for users.



Horizontal flow

This new indoor unit is capable of handling five vane positions, making it possible to achieve horizontal flow that spreads across the ceiling, maximizing the Coanda effect. This allows to avoid, if needed, direct airflow to users in the room, which can sometimes be uncomfortable.

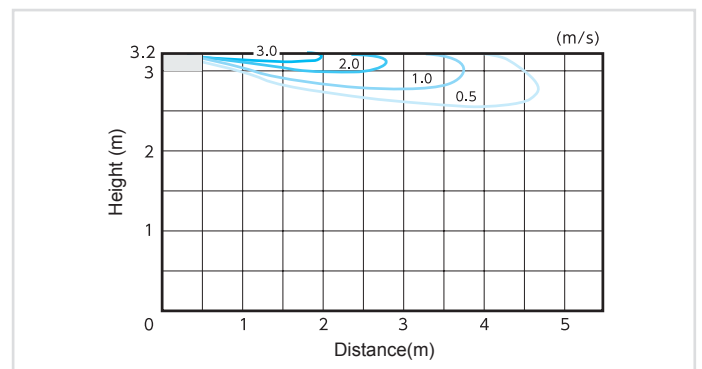
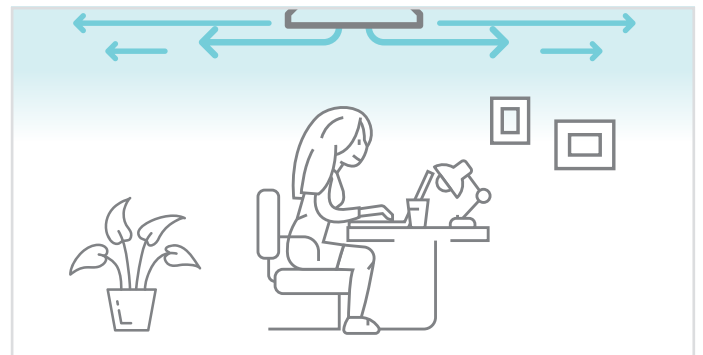



Key Technologies

3D i-see sensor: Direct/Indirect flow function

Optional 3D i-see sensor allows to detect and count users in the environment and their position. User can set either Direct or Indirect flow to occupied areas, with single control on four vanes.



3D i-see sensor: Energy saving

3D i-see sensor features allow to optimize comfort conditions and at the same time achieve energy saving. Thanks to the occupancy sensor the unit is able to automatically handle and reduce power output accordingly to users actually being present in the room or in certain areas of it. This feature is particularly helpful in those environments in which occupancy varies significantly during the day.

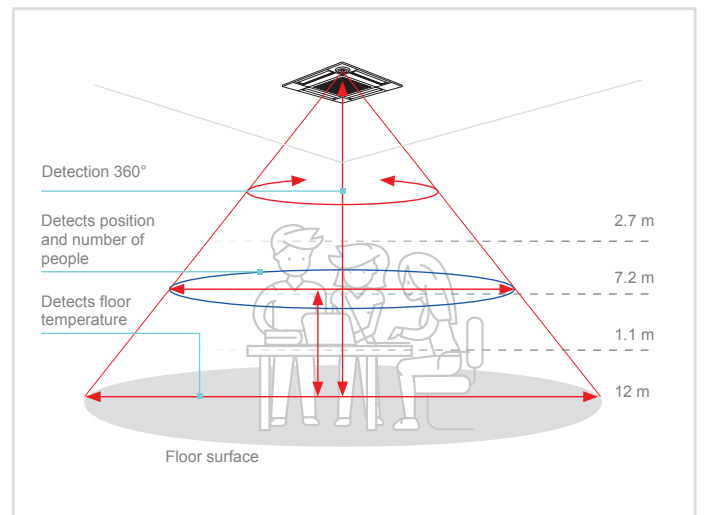

Panel and control

The unit is supplied with PLP-6EA panel which does not include signal receiver. This component (PAR-SE9FA-E) can be installed as a corner accessory, as well as 3D i-See Sensor (PAC-SE1ME-E). The unit is compatible with all wired MA and ME remote controls and, if equipped with signal receiver, wireless remote controls. New PAR-SL101A-E is compatible with PLFY-M VEM, and presents numerous new features, such as weekly timer, backlit display, 0,5°C temperature setting and monitoring, as well as functions for 3D i-see sensor (optional).



Simplified installation

Thanks to new temporary panel supports maintenance and installation operation are now easier for field technicians.



Also, panel weight has been reduced by 20% thanks to a new design.



A simple loosening of support screws allows the removal of the control box and corner accessories.



Technical specifications			PLFY-M20VEM-E	PLFY-M25VEM-E	PLFY-M32VEM-E	PLFY-M40VEM-E	PLFY-M50VEM-E
MODEL							
Power			A single phase, 220-240V 50Hz / a single phase, 200V 60Hz				
Capacity in cooling mode*1		kW	2.2	2.8	3.6	4.5	5.6
		Btu/h	7500	9600	12300	15400	19100
Capacity in heating mode*1		kW	2.5	3.2	4.0	5.0	6.3
		Btu/h	8500	10900	13600	17100	21500
Power consumption	Cooling	kW	0.03	0.03	0.03	0.03	0.03
	Heating	kW	0.03	0.03	0.03	0.03	0.03
Current	Cooling	A	0.31	0.31	0.32	0.32	0.32
	Heating	A	0.24	0.24	0.25	0.25	0.25
External finish(Munsel No.)	Unit	Galvanized steel plate					
	Grille	Nr. Munsel (1.0Y/9.2/0.2) (Bianco)					
Dimensions (HxLxW)	Unit	mm	258x840x840	258x840x840	258x840x840	258x840x840	258x840x840
	Grille	mm	40x950x950	40x950x950	40x950x950	40x950x950	40x950x950
Net weight	Unit	kg	19	19	19	19	19
	Grille	kg	5	5	5	5	5
Heat exchanger			Cross fin (Al/Cu)				
Fan	Type x Quantity	Turbo fan x 1					
	Air flow*2	m³/min	12-13-14-15	12-13-14-15	13-14-15-16	13-14-15-17	13-14-16-18
		l/s	200-217-233-250	200-217-233-250	217-233-250-267	217-233-250-283	217-233-267-300
Static ext.l pressure	Pa	0	0	0	0	0	
Motor	Type	DC Motor					
	Power output	kW	0.050	0.050	0.050	0.050	0.050
Air filter			Polypropilene honeycomb fabric				
Refrigerant pipe diameter	Gas (swaged)	mm	Ø 12.7	Ø 12.7	Ø 12.7	Ø 12.7	Ø 12.7
	Liquid (swaged)	mm	Ø 6.35	Ø 6.35	Ø 6.35	Ø 6.35	Ø 6.35
Local drain pipe diameter	Grille		O.D.32	O.D.32	O.D.32	O.D.32	O.D.32
Sound pressure*2*3		dB(A)	24-26-27-29	24-26-27-29	26-27-29-31	26-27-29-31	26-27-29-31

Technical specifications			PLFY-M63VEM-E	PLFY-M80VEM-E	PLFY-M100VEM-E	PLFY-M125VEM-E
MODEL						
Power			A single phase, 220-240V 50Hz / a single phase, 200V 60Hz			
Capacity in cooling mode*1		kW	7.1	9.0	11.2	14.0
		Btu/h	24200	30700	38200	47800
Capacity in heating mode*1		kW	8.0	10.0	12.5	16.0
		Btu/h	27300	34100	42700	54600
Power consumption	Cooling	kW	0.03	0.05	0.07	0.11
	Heating	kW	0.03	0.05	0.07	0.11
Current	Cooling	A	0.36	0.50	0.67	1.06
	Heating	A	0.29	0.43	0.60	0.99
External finish(Munsel No.)	Unit	Galvanized steel plate				
	Grille	Nr. Munsel (1.0Y/9.2/0.2) (Bianco)				
Dimensions (HxLxW)	Unit	mm	258x840x840	258x840x840	298x840x840	298x840x840
	Grille	mm	40x950x950	40x950x950	40x950x950	40x950x950
Net weight	Unit	kg	21	21	24	24
	Grille	kg	5	5	5	5
Heat exchanger			Cross fin (Al/Cu)			
Fan	Type x Quantity	Turbo fan x 1				
	Air flow*2	m³/min	14-15-16-18	14-17-20-23	20-23-26-29	22-26-30-35
		l/s	233-250-267-300	233-283-333-383	333-383-433-483	367-433-500-583
Static ext.l pressure	Pa	0	0	0	0	
Motor	Type	DC Motor				
	Power output	kW	0.050	0.050	0.120	0.120
Air filter			Polypropilene honeycomb fabric			
Refrigerant pipe diameter	Gas (swaged)	mm	Ø 15.88	Ø 15.88	Ø 15.88	Ø 15.88
	Liquid (swaged)	mm	Ø 9.52	Ø 9.52	Ø 9.52	Ø 9.52
Local drain pipe diameter	Grille		O.D.32	O.D.32	O.D.32	O.D.32
Sound pressure*2*3		dB(A)	28-29-30-32	28-31-34-37	34-37-39-41	35-39-42-45

*1 Cooling/Heating capacity is the maximum value measured in the following conditions.

Cooling: indoor 27°C (81°F) DB/19°C (66°F) WB, outdoor 35°C (95°F) BS. Heating: indoor 20°C (68°F) DB, outdoor 7°C (45°F) DB/6°C (43°F) WB.

*2 High-mid1-mid2-low setting

*3 Measured in anechoic chamber with 230V power supply.

Optional parts	DESCRIPTION
PAC-SE1ME-E	Corner 3D I-see Sensor for PLFY-M VEM-E
PLP-6EALM	Panel with wireless remote controller

PLFY-P VLMD-E

INDOOR UNITS - 2-way cassette

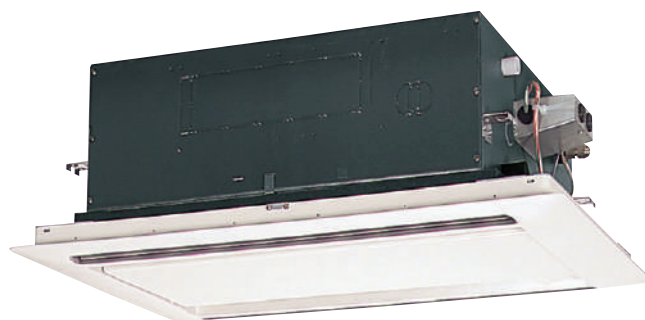

Ideal for...

The slimline housing is ideal for installation in small ceiling spaces and for replacing obsolete equipment in old buildings. In fact, the unit is just 290 mm high.

General characteristics

Terminal block

The terminal block is positioned on the outside of the main unit for easier wiring.

Direct external air intake

Clean air can enter the main unit directly (optional accessories required).

Long-life filter supplied as standard

The long-life antibacterial filter requires no maintenance for approximately one year.

Compact unit and low noise levels

15Pa noise levels (standard static pressure).

Condensate lift pump

The standard version is equipped with a mechanism with condensate lift pump. The drain can be positioned anywhere up to 583mm from the ceiling surface, allowing greater freedom of movement due to long transverse pipes and greater pipe layout versatility.

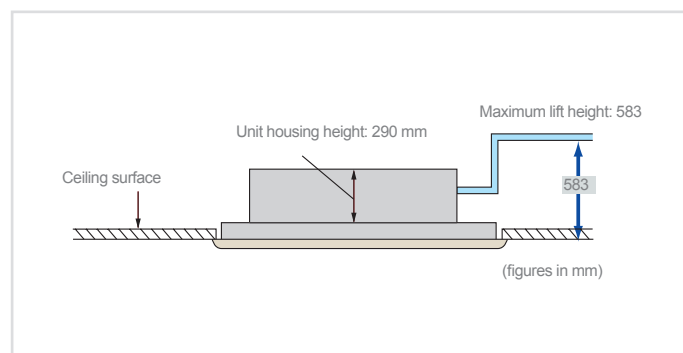

Noise level

dB(A)

Capacity		P20	P25	P32	P40	P50	P63	P80	P100	P125
Fan speed	High		33		36	37	39	39	42	46
	Medium		30		33	34	37	36	39	42/44
	Low		27		29	31	32	33	36	40

Easy installation

Installation and maintenance are made easier by the use of a lighter panel and the positioning of the switchboard close to the panel. In addition, the heat exchanger can be flushed by moving the central panel, filter and fan within the pipe layouts themselves.



Key Technologies

Technical specifications

MODEL			PLFY-P20VLMD-E	PLFY-P25VLMD-E	PLFY-P32VLMD-E	PLFY-P40VLMD-E
Power	Single phase, 220-240V 50Hz					
Capacity in cooling mode*1		kW	2.2	2.8	3.6	4.5
		Btu/h	7500	9600	12300	15400
Capacity in heating mode*1		kW	2.5	3.2	4.0	5.0
		Btu/h	8500	10900	13600	17100
Power consumption	Cooling	kW	0.072	0.072	0.072	0.081
	Heating	kW	0.065	0.065	0.065	0.074
Current	Cooling	A	0.36	0.36	0.36	0.40
	Heating	A	0.30	0.30	0.30	0.34
External finish	Unit	Galvanized steel plate				
	Grille	Nr. Munsel 6.4Y 8.9/0.4 (white)				
Dimensions AxLxP	Unit	mm	290x776x634	290x776x634	290x776x634	290x776x634
	Grille	mm	20x1080x710	20x1080x710	20x1080x710	20x1080x710
Net weight	Unit	kg	23	23	24	24
	Grille	kg	6.5	6.5	6.5	6.5
Heat exchanger	Cross fin (Al/Cu)					
Fan	Type x Quantity	Turbo fan x 1				
	Air flow*2	m³/min	6.5-8.0-9.5	6.5-8.0-9.5	6.5-8.0-9.5	7.0-8.5-10.5
		l/s	108-133-158	108-133-158	108-133-158	117-142-175
		cfm	230-283-335	230-283-335	230-283-335	247-300-371
Ext. Static pressure	Pa	0	0	0	0	
Motor	Type	1-phase induction motor				
	Ext. Static pressure	kW	0.015 (a 240V)	0.015 (a 240V)	0.015 (a 240V)	0.015 (a 240V)
Air filter	Polypropylen honeycomb (long life)					
Refrigerant pipe diameter	Gas (swaged)	mm	ø12.7	ø12.7	ø12.7	ø12.7
	Liquid (swaged)	mm	ø6.35	ø6.35	ø6.35	ø6.35
Local drain pipe diameter		mm	O.D. 32	O.D. 32	O.D. 32	O.D. 32
Sound pressure*2*3		dB(A)	28-31-34	28-31-34	28-31-34	30-34-37

*1 The heating/cooling capacity indicates the maximum values during operation under the following conditions.

Cooling: indoor 27°C (81 °F) DB/19°C(66°F) WB, outdoor 35°C (95°F) DB. Heating: indoor 20°C (68°F) DB, outdoor 7°C (45°F) DB/6°C (43°F) WB.

*2 Airflow rate/noise levels are expressed as (low-middle1-middle2-high).

*3 Measured in an anechoic chamber.

Technical specifications

MODEL			PLFY-P50VLMD-E	PLFY-P63VLMD-E	PLFY-P80VLMD-E	PLFY-P100VLMD-E	PLFY-P125VLMD-E	
Power			Single phase, 220-240V 50Hz					
Capacity in cooling mode*1		kW	5,6	7,1	9,0	11,2	14,0	
		Btu/h	19100	24200	30700	38200	47800	
Capacity in heating mode*1		kW	6,3	8,0	10,0	12,5	16,0	
		Btu/h	21500	27300	34100	42700	54600	
Power consumption	Cooling	kW	0,082	0,101	0,147	0,157	0,28	
	Heating	kW	0,075	0,094	0,140	0,150	0,27	
Current	Cooling	A	0,41	0,49	0,72	0,75	1,35	
	Heating	A	0,35	0,43	0,66	0,69	1,33	
External finish	Unit	Galvanized steel plate						
	Grille	Nr. Munsel 6.4Y 8.9/0.4 (white)						
Dimensions AxLxP	Unit	mm	290x946x634	290x946x634	290x1446x634	290x1446x634	290x1708x606	
	Grille	mm	20x1250x710	20x1250x710	20x1750x710	20x1750x710	20x2010x710	
Net weight	Unit	kg	23	28	44	47	56	
	Grille	kg	7.5	7.5	12.5	12.5	13.0	
Heat exchanger			Cross fin					
Fan	Type x Quantity		Turbo fan x 1	Turbo fan x 1	Turbo fan x 2	Turbo fan x 2	Sirocco x 4	
	Air flow*2	m³/min	6,5-8,0-9,5	11,0-13,0-15,5	15,5-18,5-22,0	17,5-21,0-25,0	24,0-27,0-30,0-33,0	
		l/s	108-133-158	167-217-258	258-308-367	292-350-417	400-450-500-550	
		cfm	230-283-335	353-459-547	547-653-777	618-742-883	848-953-1059-1165	
Ext. Static pressure	Pa	0	0	0	0	0		
Motor	Type	1-phase induction motor						
	Ext. Static pressure	kW	0,020 (a 240V)	0,020 (a 240V)	0,020 (a 240V)	0,030 (a 240V)	0,078x2 (a 240V)	
Air filter			Polypropylen honeycomb (long life)					Synthetic fiber unwoven cloth filter (long life)
Refrigerant pipe diameter	Gas (swaged)	mm	ø12,7	ø15,88	ø15,88	ø15,88	ø15,88	
	Liquid (swaged)	mm	ø6,35	ø9,52	ø9,52	ø9,52	ø9,52	
Local drain pipe diameter		mm	O.D.32	O.D.32	O.D.32	O.D.32	O.D.32	
Sound pressure*2*3		dB(A)	32-35-38	33-38-40	34-37-40	37-41-43	40-42-44-46	

*1 The heating/cooling capacity indicates the maximum values during operation under the following conditions.

Cooling: indoor 27°C (81°F) DB/19°C(66°F) WB, outdoor 35°C (95°F) DB. Heating: indoor 20°C (68° F) DB, outdoor 7°C (45° F) DB/6°C (43°F) WB.

*2 Airflow rate/noise levels are expressed as (low-middle1-middle2-high).

*3 Measured in an anechoic chamber.



PMFY-P VBM-E

INDOOR UNITS - 1-way cassette

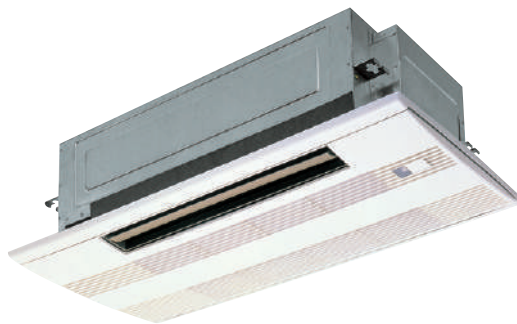

Ideal for...

Compact and light housing, perfect for applications in premises with a limited ceiling space.

Easy installation and maintenance

The dimensions of the unit housing have been standardised for all models at 854 mm to facilitate installation. The weight of the body is only 14 kg for the main unit and 3 kg for the panel, making this unit one of the lightest on the market.

Condensate lift pump

The condensate drain can be positioned anywhere up to 600 mm from the ceiling surface.

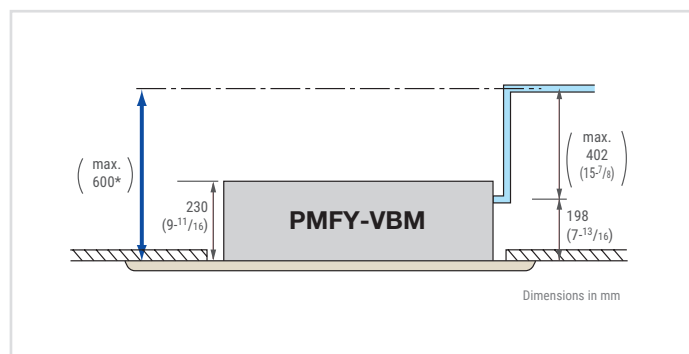

Silent operation

New airflow control technology reduces noise levels to just 27dB (P20VBM) for industry-leading quiet performance.

Improved Coanda effect

Thanks to this effect, the air tends to follow a trajectory that allows it to circulate more evenly in the air-conditioned environment.

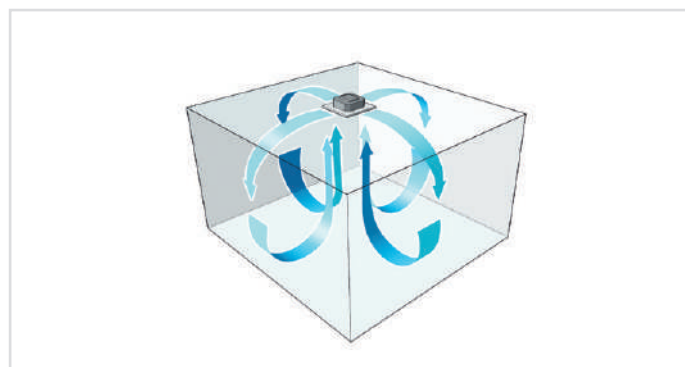



Key Technologies

Technical specifications

MODEL			PMFY-P20VBM-E	PMFY-P25VBM-E	PMFY-P32VBM-E	PMFY-P40VBM-E
Power	Single phase, 220-240V 50Hz					
Capacity in cooling mode*1		kW	2,2	2,8	3,6	4,5
		Btu/h	7500	9600	12300	15400
Capacity in heating mode*1		kW	2,5	3,2	4,0	5,0
		Btu/h	8500	10900	13600	17100
Power consumption	Cooling	kW	0,042	0,044	0,044	0,054
	Heating	kW	0,042	0,044	0,044	0,054
Current	Cooling	A	0,20	0,21	0,21	0,26
	Heating	A	0,20	0,21	0,21	0,26
External finish	Unit	Galvanized steel plate				
	Grille	Nr. Munsel 0.98Y 8.99/0.63				
Dimensions AxLxP	Unit	mm	230x812x395	230x812x395	230x812x395	230x812x395
	Grille	mm	30x1000x470	30x1000x470	30x1000x470	30x1000x470
Net weight	Unit	kg	14	14	14	14
	Grille	kg	3	3	3	3
Heat exchanger	Cross fin					
Fan	Type x Quantity	Linear Flow fan x 1				
	Air flow*2	m³/min	6,5-7,2-8,0-8,7	7,3-8,0-8,6-9,3	7,3-8,0-8,6-9,3	7,7-8,7-9,7-10,7
		l/s	108-120-133-145	122-133-143-155	122-133-143-155	128-145-162-178
		cfm	230-254-283-307	258-283-304-328	258-283-304-328	272-307-343-378
Ext. Static pressure	Pa	0	0	0	0	
Motor	Type	Single-phase induction motor				
	Ext. Static pressure	kW	0,028	0,028	0,028	0,028
Air filter	Polypropylen honeycomb (long life)					
Refrigerant pipe diameter	Gas (swaged)	mm	ø12,7	ø12,7	ø12,7	ø12,7
	Liquid (swaged)	mm	ø6,35	ø6,35	ø6,35	ø6,35
Local drain pipe diameter		mm	O.D. 26	O.D. 26	O.D. 26	O.D. 26
Sound pressure*2*3		dB(A)	27-30-33-35	32-34-36-37	32-34-36-37	33-35-37-39

*1 The heating/cooling capacity indicates the maximum values during operation under the following conditions.

Cooling: indoor 27°C (81 °F) DB/19°C(66°F) WB, outdoor 35°C (95°F) DB. Heating: indoor 20°C (68°F) DB, outdoor 7°C (45°F) DB/6°C (43° F) WB.

*2 Airflow rate/noise levels are expressed as (low-middle1-middle2-high).

*3 Measured in an anechoic chamber.

PEFY-P VMS1-E

INDOOR UNITS - Ceiling concealed medium to low static pressure

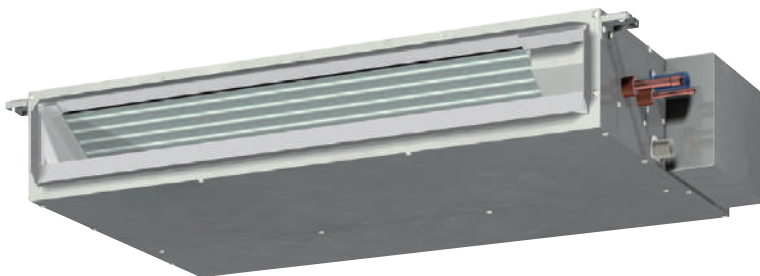

CITY MULTI

Ideal for...

This **ultra-slim 200 mm** unit offers extraordinary flexibility and is particularly suitable for use in rooms where low noise and compact vertical dimensions are essential.

Ultra-slim

These units are extremely thin, at just 200 mm in height.

Extremely compact width and lengths of:

7790 mm for P15 and P32 models

990 mm for P40 and P50 models

1190 mm for P63 models

May be installed easily in cramped spaces such as ceiling recesses or double ceilings.

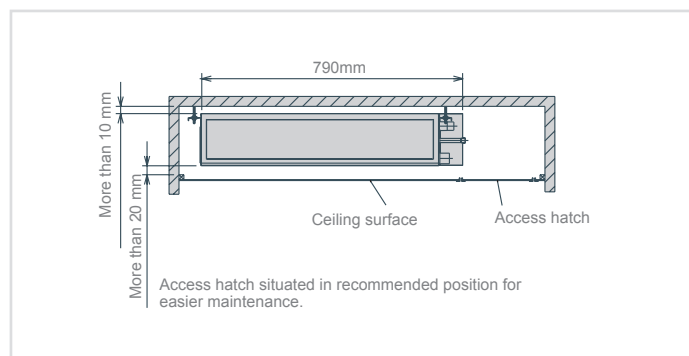

Condensate lift pump

The VMS1 is equipped with a condensate lift pump as standard.

Adjustable static pressure

L'unità è adatta per diverse applicazioni, grazie alle sue 4 impostazioni di presWith 4 selectable static pressure settings (5, 15, 25 and 50Pa), this unit is ideal for a variety of different applications.

Adjustable air flow

Three different fan speed settings - "low", "medium" and "high" – ensure the desired levels of comfort.

Low noise

The new design of the centrifugal fan and coil reduces noise levels.

Noise level

dB(A)

Capacity		P15	P20	P25	P32	P40	P50	P63
Fan speed	High		28		32	33	35	36
	Medium		24		27	30	32	33
	Low		22		24	28	30	30



Key Technologies

Technical specifications

MODEL		PEFY-P15VMS1-E	PEFY-P20VMS1-E	PEFY-P25VMS1-E	PEFY-P32VMS1-E	PEFY-P40VMS1-E	PEFY-P50VMS1-E	PEFY-P63VMS1-E	
Power		A single-phase, 220-240V 50Hz / a 1 fase, 220-240V 60Hz							
Capacity in cooling mode*1	kW	1.7	2.2	2.8	3.6	4.5	5.6	7.1	
	Btu/h	5800	7500	9600	12300	15400	19100	24200	
Capacity in heating mode*1	kW	1.9	2.5	3.2	4.0	5.0	6.3	8.0	
	Btu/h	6500	8500	10900	13600	17100	21500	27300	
Power consumption	Cooling kW	0.05 [0.03]	0.05 [0.03]	0.06 [0.04]	0.07 [0.05]	0.07 [0.05]	0.09 [0.07]	0.09 [0.07]	
	Heating kW	0.03 [0.03]	0.03 [0.03]	0.04 [0.04]	0.05 [0.05]	0.05 [0.05]	0.07 [0.07]	0.07 [0.07]	
Current	Cooling A	0.42 [0.31]	0.47 [0.36]	0.50 [0.39]	0.50 [0.39]	0.56 [0.45]	0.67 [0.56]	0.72 [0.61]	
	Heating A	0.31 [0.31]	0.36 [0.36]	0.39 [0.39]	0.39 [0.39]	0.45 [0.45]	0.56 [0.56]	0.61 [0.61]	
External finish		Galvanised							
Dimensions HxLxW		mm	200x790x700	200x790x700	200x790x700	200x790x700	200x990x700	200x990x700	200x1190x700
Net weight		kg	19 [18]	19 [18]	19 [18]	20 [19]	24 [23]	24 [23]	28 [27]
Heat exchanger		Cross fins (sheet aluminium fins and copper piping)							
Fan	Type x Quantity	Sirocco x 2				Sirocco x 3		Sirocco x 4	
	Air flow (low-medium-high) m³/min	5-6-7	5.5-6.5-8	5.5-7-9	6-8-10	8-9.5-11	9.5-11-13	12-14-16.5	
	Static external press Pa	5-15-35-50	5-15-35-50	5-15-35-50	5-15-35-50	5-15-35-50	5-15-35-50	5-15-35-50	
Motor	Type	Brushless DC motor							
	Power output kW	0.096	0.096	0.096	0.096	0.096	0.096	0.096	
Air filter		Polypropylene honeycomb fabric (washable)							
Refrigerant pipe diameter	Gas (swaged) mm	ø12.7 brazed	ø12.7 brazed	ø12.7 brazed	ø12.7 brazed	ø12.7 brazed	ø12.7 brazed	ø15.88 brazed	
	Liquid (swaged) mm	ø6.35 brazed	ø6.35 brazed	ø6.35 brazed	ø6.35 brazed	ø6.35 brazed	ø6.35 brazed	ø9.52 brazed	
Local drain pipe diameter			O.D. 32	O.D. 32	O.D. 32	O.D. 32	O.D. 32	O.D. 32	
Sound pressure (low-medium-high)			dB(A) 22-24-28	23-25-29	24-26-30	24-27-32	28-30-33	30-32-35	30-33-36

*1 For heating/cooling capacity, the maximum value with the unit operating in the following conditions is given.
 Cooling: indoor 27°C DB/19°C WB, outdoor 35°C DB.
 Heating: indoor 20°C DB (68°F DB), outdoor 7°C DB (45°F DB/43°F WB). Pipe length: 7.5 m (24-9/16 feet).
 Height difference: 0 m (0 feet).

*2 Static external pressure is set to 15 Pa by default.

*3 [] in case of PEFY-P15-63VMS1L-E.

PEFY-M VMA-A

INDOOR UNITS - Ceiling concealed medium to high static pressure



CITY MULTI

Ideal for...

Featuring very precise ambient temperature control, the VMA series ducted unit offers **unparalleled energy efficiency**.

Static pressure

Static external pressure is adjustable to suit the system configuration and installation conditions. The static pressure may be modified to cater for all types of ducting and to allow for functional upgrades such as installing high performance filters, etc. To cater for different layouts and configurations, the static pressure is adjustable within a range from 35Pa to 150 Pa.

Compact unit

The entire VMA series offers extraordinarily compact dimensions: measuring just 250 mm in height, this is the perfect solution for installation in cramped spaces.

Condensate lift pump

The VMA is equipped with a condensate lift pump.

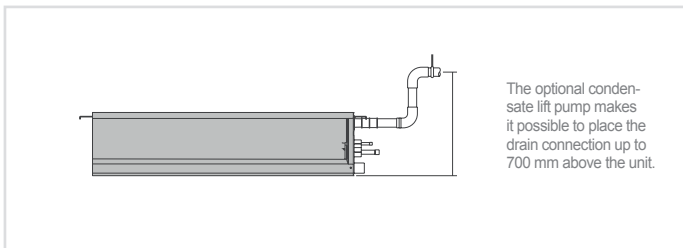

Air inlet direction can easily be changed

By only switching the closing board and air filter, the inlet layout can be altered from the rear inlet. (At the time of factory shipment: rear inlet)

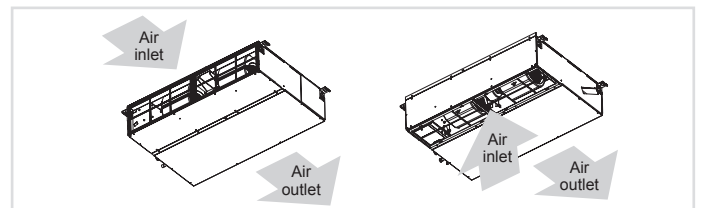

Less power consumption

Improved air pathway inside the fan casing provides smooth air flow for more efficient operation. Additionally, the new higher-efficiency motor reduces energy consumption.

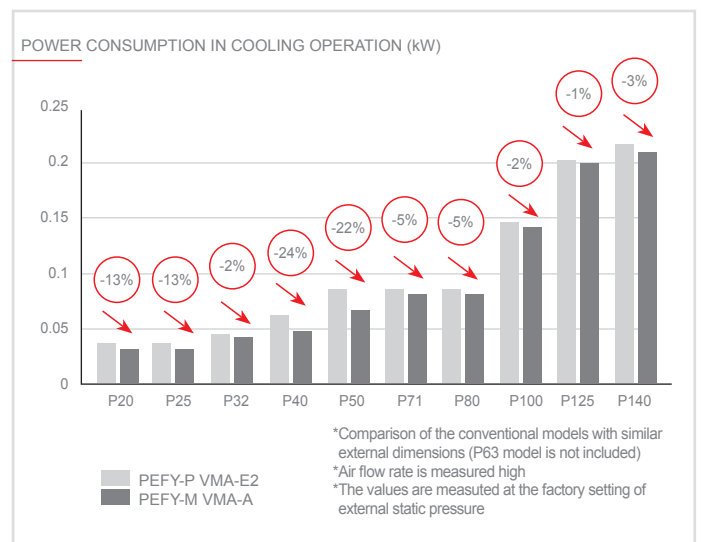



Key Technologies

Technical specifications

MODEL			PEFY-M20VMA-A	PEFY-M25VMA-A	PEFY-M32VMA-A	PEFY-M40VMA-A
Power			1-phase 220-230-240 V 50 Hz			
Capacity in cooling mode *1		kW	2.2	2.8	3.6	4.5
		Btu/h	7,500	9,600	12,300	15,400
Capacity in heating mode*1		kW	2.5	3.2	4.0	5.0
		Btu/h	8,500	10,900	13,600	17,100
Power consumption	Cooling	kW	0.032	0.032	0.044	0.047
	Heating	kW	0.030	0.030	0.042	0.045
Current	Cooling	A	0.25	0.25	0.34	0.37
	Heating	A	0.25	0.25	0.34	0.37
External finish			Galvanized steel plate			
Dimensions HxLxW		mm	250 x 700 x 732	250 x 700 x 732	250 x 700 x 732	250 x 900 x 732
Net weight		kg	21	21	21	25
Heat exchanger			Cross fin (Aluminum fin and copper tube)			
Fan	Type x Quantity		Sirocco x 1	Sirocco x 1	Sirocco x 1	Sirocco x 2
	Air flow (low-medium-high)	m³/min	6.0 - 7.5 - 8.5	6.0 - 7.5 - 8.5	7.5 - 9.0 - 10.5	10.0 - 12.0 - 14.0
		l/s	100 - 125 - 142	100 - 125 - 142	125 - 150 - 175	167 - 200 - 233
		cfm	212 - 265 - 300	212 - 265 - 300	265 - 318 - 371	353 - 424 - 494
External static press *2	Pa	35 - <50> - <70> - <100> - <150>	35 - <50> - <70> - <100> - <150>	35 - <50> - <70> - <100> - <150>	35 - <50> - <70> - <100> - <150>	
Motor	Type		DC Motor			
	Power output	kW	0.085	0.085	0.085	0.121
Air filter			Polypropylene honeycomb fabric (washable)			
Refrigerant pipe diameter	Gas (brazed)	mm	12.7	12.7	12.7	12.7
	Liquid (brazed)	mm	6.35	6.35	6.35	6.35
Local drain pipe diameter			O.D.32 (1-1/4")	O.D.32 (1-1/4")	O.D.32 (1-1/4")	O.D.32 (1-1/4")
Sound pressure (low-medium-high)*3		dB(A)	21 - 25 - 27	21 - 25 - 27	23 - 27 - 30	23 - 28 - 31

*1 For heating/cooling capacity, the maximum value with the unit operating in the following conditions is given.
 Cooling: indoor 27°C (81°F) DB/19°C (66°F) WB, outdoor 35°C (95°F) DB. Heating: indoor 20°C (68°F) DB, outdoor 7°C (45°F) DB/6°C (43°F) WB.
 *2 The factory setting of airflow mode and external static pressure mode is shown without < >.
 *3 Measured in anechoic chamber with 230V mains power and at the factory setting of external static pressure.

Technical specifications

MODEL			PEFY-M50VMA-A	PEFY-M63VMA-A	PEFY-M71VMA-A	PEFY-M80VMA-A	
Power	1-phase 220-230-240 V 50 Hz						
Capacity in cooling mode *1	kW		5.6	7.1	8.0	9.0	
	Btu/h		19,100	24,200	27,300	30,700	
Capacity in heating mode*1	kW		6.3	8.0	9.0	10.0	
	Btu/h		21,500	27,300	30,700	34,100	
Power consumption	Cooling	kW	0.066	0.087	0.080	0.080	
	Heating	kW	0.064	0.085	0.078	0.078	
Current	Cooling	A	0.51	0.66	0.57	0.57	
	Heating	A	0.51	0.66	0.57	0.57	
External finish	Galvanized steel plate						
Dimensions HxLxW	mm		250 x 900 x 732	250 x 900 x 732	250 x 1,100 x 732	250 x 1,100 x 732	
Net weight	kg		25	27	30	30	
Heat exchanger	Cross fin (Aluminum fin and copper tube)						
Fan	Type x Quantity		Sirocco x 2	Sirocco x 2	Sirocco x 2	Sirocco x 2	
	Air flow (low-medium-high)	m ³ /min	12.0 - 14.5 - 17.0	13.5 - 16.0 - 19.0	14.5 - 18.0 - 21.0	14.5 - 18.0 - 21.0	
		l/s	200 - 242 - 283	225 - 267 - 317	242 - 300 - 350	242 - 300 - 350	
		cfm	424 - 512 - 600	477 - 565 - 671	512 - 636 - 742	512 - 636 - 742	
External static press ²	Pa	35 - <50> - <70> - <100> - <150>	35 - <50> - <70> - <100> - <150>	40 - <50> - <70> - <100> - <150>	40 - <50> - <70> - <100> - <150>		
Motor	Type	DC Motor					
	Power output	kW	0.121	0.121	0.121	0.121	
Air filter	Polypropylene honeycomb fabric (washable)						
Refrigerant pipe diameter	Gas (brazed)	mm	12.7	15.88	15.88	15.88	
	Liquid (brazed)	mm	6.35	9.52	9.52	9.52	
Local drain pipe diameter	O.D.32 (1-1/4")						
Sound pressure (low-medium-high)*3	dB(A)		24 - 31 - 34	27 - 31 - 35	25 - 31 - 34	25 - 31 - 34	

*1 For heating/cooling capacity, the maximum value with the unit operating in the following conditions is given.
Cooling: indoor 27°C (81°F) DB/19°C (66°F) WB, outdoor 35°C (95°F) DB. Heating: indoor 20°C (68°F) DB, outdoor 7°C (45°F) DB/6°C (43°F) WB.
*2 The factory setting of airflow mode and external static pressure mode is shown without < >.
*3 Measured in anechoic chamber with 230V mains power

Technical specifications

MODEL			PEFY-M100VMA-A	PEFY-M125VMA-A	PEFY-M140VMA-A	
Power	1-phase 220-230-240 V 50 Hz					
Capacity in cooling mode *1	kW		11.2	14.0	16.0	
	Btu/h		38,200	47,800	54,600	
Capacity in heating mode*1	kW		12.5	16.0	18.0	
	Btu/h		42,700	54,600	61,400	
Power consumption	Cooling	kW	0.142	0.199	0.208	
	Heating	kW	0.140	0.197	0.206	
Current	Cooling	A	0.97	1.23	1.34	
	Heating	A	0.97	1.23	1.34	
External finish	Galvanized steel plate					
Dimensions HxLxW	mm		250 x 1,400 x 732	250 x 1,400 x 732	250 x 1,600 x 732	
Net weight	kg		37	38	42	
Heat exchanger	Cross fin (Aluminum fin and copper tube)					
Fan	Type x Quantity		Sirocco x 3	Sirocco x 3	Sirocco x 3	
	Air flow (low-medium-high)	m ³ /min	23.0 - 28.0 - 32.0	28.0 - 34.0 - 37.0	29.5 - 35.5 - 40.0	
		l/s	383 - 467 - 533	467 - 567 - 617	492 - 592 - 667	
		cfm	812 - 989 - 1,130	989 - 1,201 - 1,306	1,042 - 1,254 - 1,412	
External static press ²	Pa	40 - <50> - <70> - <100> - <150>	40 - <50> - <70> - <100> - <150>	40 - <50> - <70> - <100> - <150>		
Motor	Type	DC Motor				
	Power output	kW	0.300	0.300	0.300	
Air filter	Polypropylene honeycomb fabric (washable)					
Refrigerant pipe diameter	Gas (swaged)	mm	15.88	15.88	15.88	
	Liquid (swaged)	mm	9.52	9.52	9.52	
Local drain pipe diameter	O.D.32 (1-1/4")					
Sound pressure (low-medium-high)*3	dB(A)		30 - 35 - 38	34 - 38 - 40	33 - 37 - 40	

*1 For heating/cooling capacity, the maximum value with the unit operating in the following conditions is given.
Cooling: indoor 27°C (81°F) DB/19°C (66°F) WB, outdoor 35°C (95°F) DB. Heating: indoor 20°C (68°F) DB, outdoor 7°C (45°F) DB/6°C (43°F) WB.
*2 The factory setting of airflow mode and external static pressure mode is shown without < >.
*3 Measured in anechoic chamber with 230V mains power



PEFY-P VMHS-E

INDOOR UNITS - Ceiling concealed high static pressure



CITY MULTI

Four levels of external static pressure settings

Although the conventional models only had three levels of external static pressure, the new models offer four levels of external static pressure. The additional external static pressure capacity provides flexibility for duct extension, branching and air outlet configuration.

PEFY-P VMHS-E	P40	P50	P63	P71	P80	P100	P125	P140
External static pressure (Pa)	50-<100>-<150>-<200>							

The factory setting of external static pressure is shown without < > . Refer to "Fan characteristics curves", according to the external static pressure, in DATA BOOK for the usable range of air flow rate.

Three fan speeds (Low/Mid/High) to choose from

The conventional models had two levels of fan speed, the new models offer three levels of fan speed (Low/Mid/High). Combined with a wider selection of external static pressure levels, the new models offer optimal operation settings to suit the air-conditioning load of an Installation space.

Reduction weight

Downsizing of the motor helped reduce unit weight, offering easier installation.

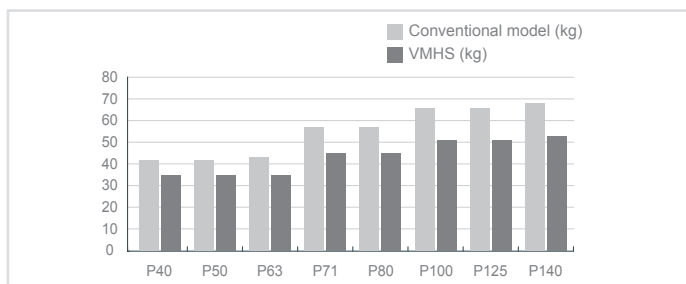

The use of DC motor

The new models are equipped with high-efficiency DC motors as compared to the AC motors on older models, which reduced power consumption. On the P80 models, power consumption is reduced by 59%*.

*Comparison made at 50 Hz, 220 V, 100 Pa Low fan speed

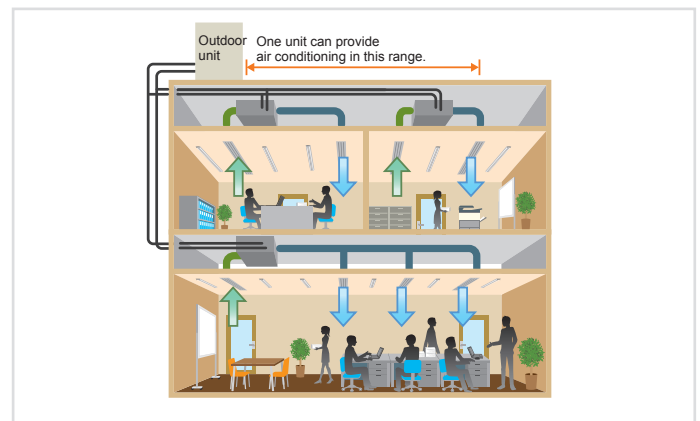

Optional drain pump

Use of high-efficiency DC motor for the drain pump motor on the new models reduces power consumption by 90%, in comparison to that on the conventional models. The pump head height of 550 mm provides for greater piping design flexibility.

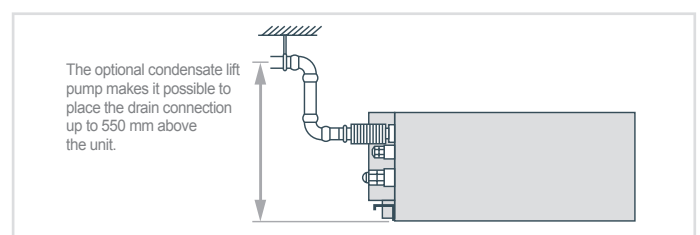



Key Technologies

Technical specifications

MODEL		PEFY-P40VMHS-E	PEFY-P50VMHS-E	PEFY-P63VMHS-E	PEFY-P71VMHS-E	PEFY-P80VMHS-E	PEFY-P100VMHS-E	PEFY-P125VMHS-E	PEFY-P140VMHS-E	
Power		A single-phase, 220-230-240V 50/60 Hz								
Capacity in cooling mode *1	kW	4,5	5,6	7,1	8,0	9,0	11,2	14,0	16,0	
	Btu/h	15,400	19,100	24,200	27,300	30,700	38,200	47,800	54,600	
Capacity in heating mode*1	kW	5,0	6,3	8,0	9,0	10,0	12,5	16,0	18,0	
	Btu/h	17,100	21,500	27,300	30,700	34,100	42,700	54,600	61,400	
Power consumption	Cooling kW	0,055	0,055	0,090	0,075	0,090	0,160	0,160	0,190	
	Heating kW	0,055	0,055	0,090	0,075	0,090	0,160	0,160	0,190	
Current	Cooling A	0,41-0,39-0,38	0,41-0,39-0,38	0,64-0,62-0,59	0,54-0,52-0,50	0,63-0,61-0,58	1,05-1,01-0,96	1,05-1,01-0,96	1,24-1,19-1,14	
	Heating A	0,41-0,39-0,38	0,41-0,39-0,38	0,64-0,62-0,59	0,54-0,52-0,50	0,63-0,61-0,58	1,05-1,01-0,96	1,05-1,01-0,96	1,24-1,19-1,14	
External finish		Galvanized								
Dimensions HxLxW	mm	380x745x900	380x745x900	380x745x900	380x1030x900	380x1030x900	380x1195x900	380x1195x900	380x1195x900	
Net weight	kg	35	35	35	45	45	51	51	53	
Heat exchanger		Cross fins (aluminium fins and copper piping)								
Fan	Type x Quantity	Sirocco x 1		Sirocco x 1	Sirocco x 2	Sirocco x 2	Sirocco x 2	Sirocco x 2	Sirocco x 2	
	Air flow (low-medium-high)	m³/min	10,0-12,0-14,0	10,0-12,0-14,0	13,5-16,0-19,0	15,5-18,0-22,0	18,0-21,5-25,0	26,5-32,0-38,0	26,5-32,0-38,0	28,0-34,0-40,0
		l/s	167-200-233	167-200-233	225-267-317	258-300-367	300-358-417	442-533-633	442-533-633	467-567-667
	cfm	353-424-494	353-424-494	477-565-671	547-636-777	636-759-883	936-1130-1342	936-1130-1342	989-1201-1412	
Static external press	Pa	50 - 100 -150 - 200	50 - 100 -150 - 200	50 - 100 -150 - 200	50 - 100 -150 - 200	50 - 100 -150 - 200	50 - 100 -150 - 200	50 - 100 -150 - 200	50 - 100 -150 - 200	
Motor	Type	Motor DC								
	Power output	kW	0,121	0,121	0,121	0,244	0,244	0,375	0,375	0,375
Air filter		-								
Refrigerant pipe diameter	Gas (swaged)	mm	12,7	12,7	15,88	15,88	15,88	15,88	15,88	15,88
	Liquid (swaged)	mm	6,35	6,35	9,52	9,52	9,52	9,52	9,52	9,52
Local drain pipe diameter		O.D 32								
Sound pressure (low-medium-high)*2	dB(A)	20-23-27	20-23-27	24-27-32	24-26-30	25-27-30	27-31-34	27-31-34	27-32-36	

*1 For heating/cooling capacity, the maximum value with the unit operating in the following conditions is given:

Cooling: 27°C DB / 19°C WB, outdoor 35°C DB.

Heating: 27°C DB, outdoor 7°C DB / 6°C WB.

*2 Static pressure is set to 50 Pa by default.

*3 Measured in anechoic chamber.

PEFY-P VMHS-E

INDOOR UNITS - Ceiling concealed high static pressure

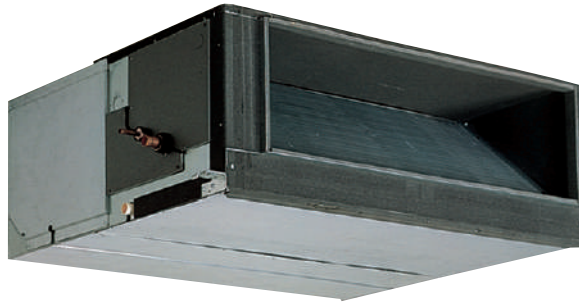

CITY MULTI

Ideal for...

The new VMHS series: improved **installation flexibility** and superior performance.

DC Inverter motor

The new VMHS ducted indoor units are equipped with a single-phase DC Inverter electric motor, a solution that offers more precise electronic control and less noise.

Remotely settable static overpressure

The static overpressure may be modified from a remote control. In addition to a dip switch on the unit, the PAR-41MAA remote control may also be used to modify static external pressure, making installation significantly simpler.

A choice of up to five different settings is available: 50, 100, 150, 200 or 250 Pa.

Automatic fan speed adjustment

The automatic fan speed adjustment mode ensures fast, comfortable heating as soon as heating mode is activated. Automatic fan speed control is included in the three standard modes "Low", "Medium" and "High", and ensures faster, comfortable air conditioning by increasing the air flow speed on activation and then reducing speed once stable comfort levels are attained.

Quieter

The VMHS series is 15% quieter than the previous VMH model.

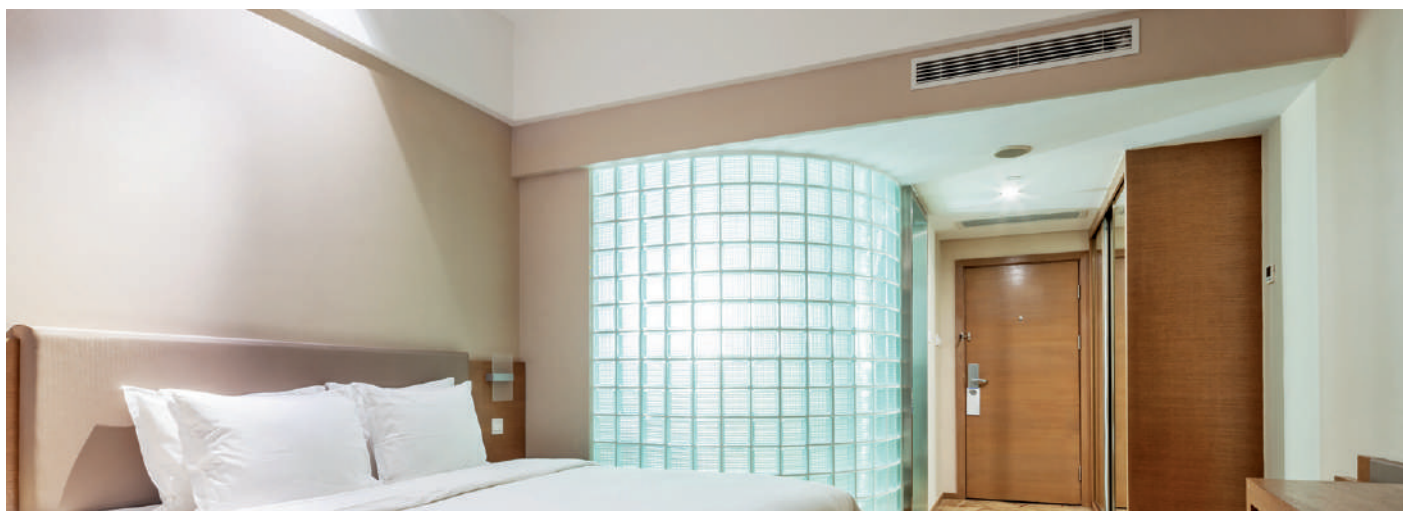

Key Technologies

Technical specifications

MODEL			PEFY-P200VMHS-E	PEFY-P250VMHS-E
Power	A single-phase, 220-240V, 50Hz			
Capacity in cooling mode *1		kW	22.4	28.0
		Btu/h	76,000	95,500
Capacity in heating mode*1		kW	25.0	31.5
		Btu/h	72,300	90,400
Power consumption	Cooling	kW	0.63/0.63/0.63	0.82/0.82/0.82
	Heating	kW	0.63/0.63/0.63	0.82/0.82/0.82
Current	Cooling	A	3.47/3.32/3.18	4.72/4.43/4.14
	Heating	A	3.47/3.32/3.18	4.72/4.43/4.14
External finish	Galvanised			
Dimensions HxLxW		mm	470 x 1250 x 1120	470 x 1250 x 1120
Net weight		kg	97	100
Heat exchanger	Cross Fin			
Fan	Type x Quantity		Sirocco x 2	
	Air flow (low-medium-high)	m³/min	50-61-72	58-71-84
	Static external press*2	Pa	(50)/(100)/150/(200)/(250)	
Motor	Type		Single-phase induction motor	
	Power output	kW	0.87	0.87
Air filter	-			
Refrigerant pipe diameter	Gas (swaged)	mm	19.05	22.2
	Liquid (swaged)	mm	9.52	9.52
Local drain pipe diameter	32			
Sound pressure (low-medium-high)*3		dB(A)	36-39-43	39-42-46

*1 For heating/cooling capacity, the maximum value with the unit operating in the following conditions is given:

Cooling: 27°C DB / 19°C WB, outdoor 35°C DB.

Heating: 27°C DB, outdoor 7°C DB / 6°C WB.

*2 Static pressure is set to 150 Pa by default.

*3 Measured in anechoic chamber.

PCFY-P VKM-E

INDOOR UNITS - Ceiling-suspended



CITY MULTI

Ideal for...

Designed and built for quiet operation and simple maintenance, these units deliver efficient, comfortable air conditioning performance.

Optimised air flow

Air flow speed is optimised for the height of the ceiling. The ideal air flow setting may be selected for ceilings up to 4.2m in height, maximising both air conditioning efficacy and comfort.

Extremely simple installation

With the direct mount system, it is not necessary to remove the mounting from the main unit, cutting installation times.

The condensate drain pipes may be connected on the left or right of the unit.

Automatic fan speed adjustment

As well as the 4 manual fan speed settings, the PCFY series may also be set to automatically adjust fan speed in relation to ambient conditions: the fan speed is always set to the highest setting when the unit is switched on, to reach the desired conditions more quickly, and is reduced automatically near the setpoint for stable comfort.

Extra slim

Extremely slim and with elegant curves, the PCFY series is perfectly suited to any interior. The unit also features a single air outlet, meaning that the automatic swing vane also doubles as a shutter when the unit is off.



Automatic swing vane

The automatic swing vane mode distributes air more uniformly. The vane swings upwards and downwards automatically to distribute air effectively into every corner of the room.

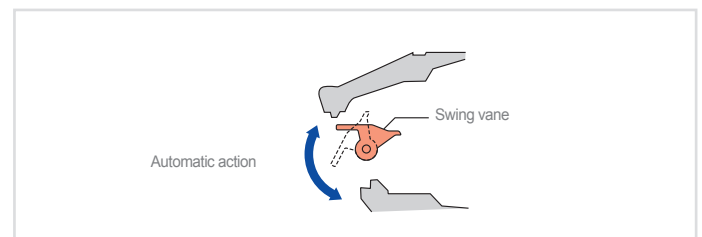



Key Technologies

Technical specifications

MODEL			PCFY-P40VKM-E	PCFY-P63VKM-E	PCFY-P100VKM-E	PCFY-P125VKM-E	
Power	A single-phase, 220-230-240VAC 50Hz						
Capacity in cooling mode*1	kW		4.5	7.1	11.2	14.0	
	Btu/h		15400	24200	38200	47800	
Capacity in heating mode*1	kW		5.0	8.0	12.5	16.0	
	Btu/h		17100	27300	42700	54600	
Power consumption	Cooling	kW	0.04	0.05	0.09	0.11	
	Heating	kW	0.04	0.05	0.09	0.11	
Current	Cooling	A	0.28	0.33	0.65	0.76	
	Heating	A	0.28	0.33	0.65	0.76	
External finish	Munsell 6.4Y 8.9/ 0.4						
Dimensions HxLxW	mm		230x960x680	230x1280x680	230x1600x680	230x1600x680	
Net weight	kg		24	32	36	38	
Heat exchanger	Cross fins (aluminium fins and copper piping)						
Fan	Type x Quantity		Sirocco x 2	Sirocco x 3	Sirocco x 4	Sirocco x 4	
	Air flow (low-medium-high)	m³/min	10-11-12-13	14-15-16-18	21-24-26-28	21-24-27-31	
		l/s	167-183-200-217	233-250-267-300	350-400-433-467	350-400-450-517	
	Static external press	Pa	0	0	0	0	
Motor	Type	Single-phase DC motor					
	Power output	kW	0.090	0.095	0.160	0.160	
Air filter	Polypropylene honeycomb fabric (long life)						
Refrigerant pipe diameter	Gas (swaged)	mm	ø12.7	ø15.88	ø15.88 / ø19.05 (compatible)	ø15.88 / ø19.05 (compatible)	
	Liquid (swaged)	mm	ø6.35	ø9.52	ø9.52	ø9.52	
Local drain pipe diameter	O.D. 26 (1)						
Sound pressure (low-medium-high)*2		dB(A)	29-32-34-36	31-33-35-37	36-38-41-43	36-39-42-44	

*1 For heating/cooling capacity, the maximum value with the unit operating in the following conditions is given.

Cooling: indoor 27°C (81°F) DB/19°C (66°F) WB, outdoor 35°C (95°F) DB. Heating: indoor 20°C (68°F) DB, outdoor 7°C (45°F) DB/6°C (43°F) WB.

*2 Air flow/noise levels given for operation in low-medium1-medium2-high modes.

*3 Measured in anechoic chamber.

PKFY-P VLM-E

INDOOR UNITS - Wall-mounted



CITY MULTI

New design

A sharp and simple form that combines beauty and function. The simple square design harmonizes beautifully with the straight lines created by the intersection of the walls, floor and ceiling of the space. With a new white body color, it is the ideal solution for residential applications, offices and large stores.

New line-up

New exclusive P10 model is added in wall mounted lineup. P10 size allows to respond to the needs of narrow spaces conditioning them finely. In addition, miniaturization of conventional P32 model has been realized. It contributes to space saving of installation area.

Capacity	P10	P15	P20	P25	P32	P40	P50	P63	P100
VLM	NEW	•	•	•	•	•	•		

Horizontal airflow

The vane angle can be set to five steps, including the one that allows horizontal air flow, reducing the feeling of draft. Besides, 4 steps of air speed are available.

		Fan Speed 	Vane Control	
			Vane Angle 	Swing mode
Conventional	PKFY-P** VBM	4 speeds	4 steps	---
	PKFY-P** VHM	3 speeds + AUTO	5 steps	✓

NEW	PKFY-P** VLM-E	4 speeds + AUTO	5 steps	✓
------------	-------------------	-----------------------	---------	---

Quietness...

The noise level has been significantly reduced compared to the conventional model by reviewing the unit structure and improving the line flow fan.

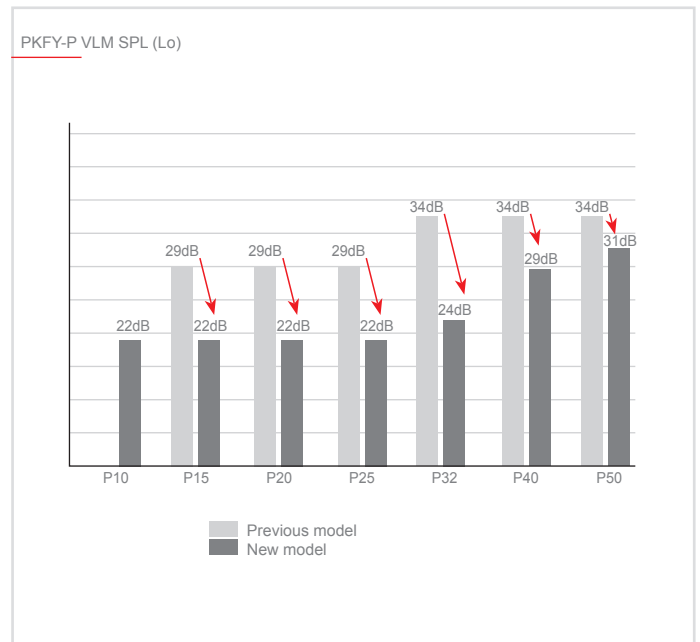



Key Technologies

Technical specifications

MODEL		PKFY-P10VLM-E	PKFY-P15VLM-E	PKFY-P20VLM-E	PKFY-P25VLM-E	PKFY-P32VLM-E	PKFY-P40VLM-E	PKFY-P50VLM-E	
Power		A single-phase, 220-240V 50Hz, A single-phase, 220-230V 60Hz							
Capacity in cooling mode*1	kW	1.2	1.7	2.2	2.8	3.6	4.5	5.6	
	Btu/h	4100	5800	7500	9600	12300	15400	19100	
Capacity in heating mode*1	kW	1.4	1.9	2.5	3.2	4.0	5.0	6.3	
	Btu/h	4800	6500	8500	10900	13600	17100	21500	
Power consumption	Cooling kW	0.02	0.02	0.02	0.03	0.04	0.04	0.05	
	Heating kW	0.01	0.01	0.01	0.02	0.03	0.03	0.04	
Current	Cooling A	0.20	0.20	0.20	0.25	0.35	0.35	0.45	
	Heating A	0.15	0.15	0.15	0.20	0.30	0.30	0.40	
External finish		Plastic (0.7PB 9.2/0.4)							
Dimensions HxLxW	mm	299 x 773 x 237					299 x 898 x 237		
Net weight	kg	11 (25)					13 (29)		
Heat exchanger		Cross fin (Aluminium fin and copper tube)							
Fan	Type x Quantity	Line flow fan x 1							
	Air flow *2	m³/min	3.3-3.5-3.8-4.2	4.0-4.2-4.4-4.7	4.0-4.4-4.9-5.4	4.0-4.6-5.4-6.7	4.3-5.4-6.9-8.4	6.3-7.4-8.6-10.0	6.8-8.3-10.2-12.4
		l/s	55-58-63-70	67-70-73-78	67-73-82-90	67-77-90-112	72-90-115-140	105-123-143-167	113-138-170-207
	cfm	117-124-134-148	141-148-155-166	141-155-173-191	141-162-191-237	152-191-244-297	222-261-304-353	240-293-360-438	
Static external press	Pa	0 (0)							
Motor	Type	DC motor							
	Power output kW	0.03							
Air filter		PP Honeycomb							
Refrigerant pipe diameter	Gas (swaged) mm	Ø 12.7 (Ø1/2)							
	Liquid (swaged) mm	Ø 6.35 (Ø1/4)							
Local drain pipe diameter		I.D. 16 (5/8)							
Sound pressure *2 *3	dB(A)	22-24-26-28	22-24-26-28	22-26-29-31	22-27-31-35	24-31-37-41	29-34-37-40	31-36-41-46	

*1 For heating/cooling capacity, the maximum value with the unit operating in the following conditions is given.
Cooling: indoor 27°C (81°F) DB/19°C (66°F) WB, outdoor 35°C (95°F) DB. Heating: indoor 20°C (68°F) DB, outdoor 7°C (45°F) DB/6°C (43°F) WB.
*2 Air flow/noise levels given for operation in low-medium1-medium2-high modes.
*3 Measured in anechoic chamber.

PKFY-P VKM-E

INDOOR UNITS - Wall-mounted



CITY MULTI

Ideal for...

An elegant design with simple, clean lines, compact dimensions and a distinctly recognisable family look: **the ideal solution for residential applications, offices and large stores.**

Smooth front panel with pure white finish

All the models of the PKFY series now feature a smooth front panel instead of the mesh used on the previous version. The units themselves are now finished in pure white instead of standard appliance white to fit in perfectly with the style of practically any interior space.



Capacity	P15	P20	P25	P32	P40	P50	P63	P100
VKM							•	•

Key Technologies VKM (P63-P100)



Technical specifications

MODEL			PKFY-P63VKM-E	PKFY-P100VKM-E
Power	A single-phase, 220-230-240VAC 50Hz			
Capacity in cooling mode*1	kW		7.1	11.2
	Btu/h		24200	38200
Capacity in heating mode*1	kW		8.0	12.5
	Btu/h		27300	42600
Power consumption	Cooling	kW	0.05	0.08
	Heating	kW	0.04	0.07
Current	Cooling	A	0.37	0.58
	Heating	A	0.30	0.51
External finish	Munsell plastic 1.0Y 9.2/0.2			
Dimensions HxLxW		mm	365x1170x295	365x1170x295
Net weight		kg	21	21
Heat exchanger	Cross fins (aluminium fins and copper piping)			
Fan	Type x Quantity	Linear flow fan x 1		
	Air flow (low-medium-high)	m ³ /min	16-20	20-26
		l/s	267-333	333-433
		cfm	565-706	706-918
Static external press	Pa	0	0	
Motor	Type			
	Power output	kW	0.056	0.056
Air filter	Polypropylene honeycomb fabric (washable)			
Refrigerant pipe diameter	Gas (swaged)	mm	ø15.88	ø15.88 / 19.05
	Liquid (swaged)	mm	ø9.52	ø9.52
Local drain pipe diameter	I.D. 16 (5/8)			I.D. 16 (5/8)
Sound pressure (low-medium-high)*2		dB(A)	39-45	41-49

*1 For heating/cooling capacity, the maximum value with the unit operating in the following conditions is given.
Cooling: indoor 27°C (81°F) DB/19°C (66°F) WB, outdoor 35°C (95°F) DB. Heating: indoor 20°C (68°F) DB, outdoor 7°C (45°F) DB/6°C (43°F) WB.

*2 Air flow/noise levels given for operation in low-medium1-medium2-high modes, in low-medium-high modes or in low-high modes, depending on model.
Measured in anechoic chamber.

PAC-LV11-E

INDOOR UNITS - Wall-mounted design indoor unit LEV Kit



CITY MULTI

Ideal for...

The new LEV Kit may be used to connect both standard VRF indoor units and Residential line indoor units in the same CITY MULTI VRF system.

The new LEV Kit makes it possible to connect stylish residential indoor units, with looks that are perfectly suited for large installations in applications such as residential buildings and hotels, where design is a decisive factor in the choice of indoor units.







Easy installation and maintenance

The new LEV Kit is easy to install in double ceilings or dedicated niches not only because of its compact size (183 mm H x 355 mm L x 142 mm W), but also and especially because it can be installed vertically or horizontally with no condensate drain.

Additionally, a maximum permissible piping length of 15 m between indoor units and the LEV Kit offers the freedom to install the kit in the most effective position possible.

Residential indoor units





The following residential indoor units may be connected to the LEV Kit:

Types and Sizes available Residential indoor units	15	18	20	22	25	35	42	50
MSZ-LN_VG(2) 		•				•		•
MSZ-AP_VG(K) 	•		•		•	•	•	•
MSZ-EF_VE/VG 		•		•	•	•	•	•
MSZ-SF_VAVE3 	•		•	•	•	•	•	•
MFZ-KJ_VE 					•	•		•
MFZ-KT_VG 					•	•		•

ATTENTION !! FOR DETAILS ON COMPATIBILITY BETWEEN EACH MODEL OF INDOOR UNITS AND OUTDOOR UNITS PLEASE CONTACT YOUR LOCAL DISTRIBUTOR

Unparalleled comfort and air quality

The quality of an environment also depends on perceived noise levels. Mitsubishi Electric air conditioners connected to a VRF CITY MULTI system using the LEV Kit offer the highest levels of acoustic comfort available today on the market.

Interior of a train	Interior of a quiet car (40 km/h)	Inside a library	Sound of rustling leaves	Limit of human hearing
				
80dB(A)	60dB(A)	40dB(A)	22dB(A) SEZ-KD	10dB(A)

The residential indoor units also contribute to higher air quality levels with the superior filtration power of air filters with nanoplatinum treatment.



Key Technologies

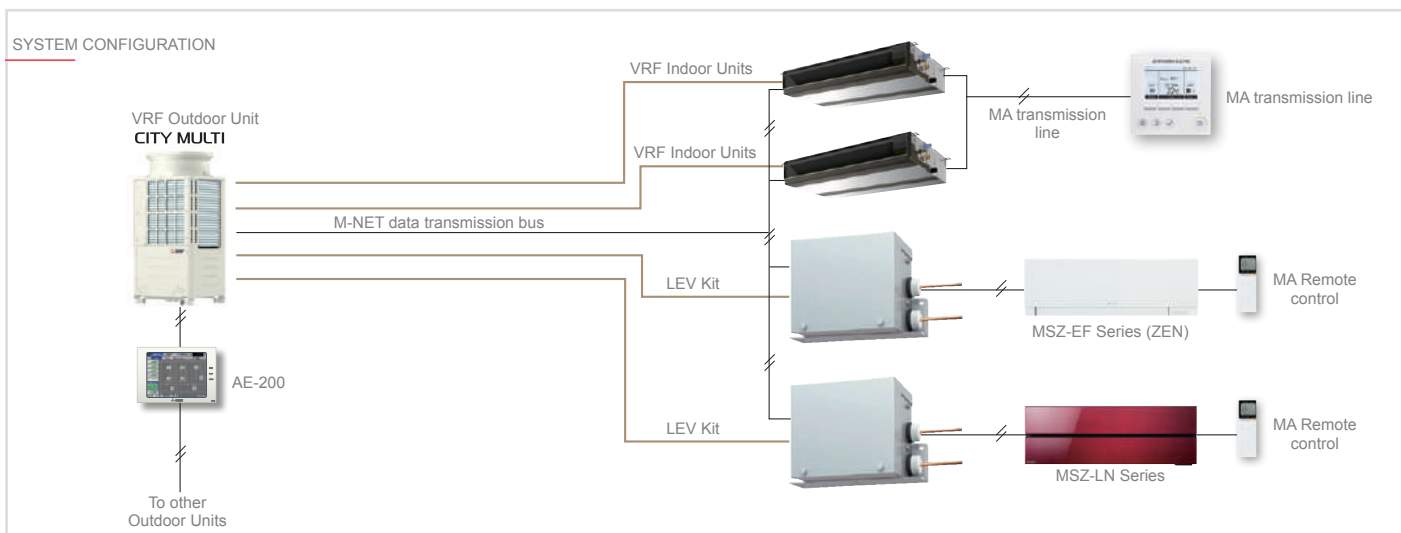

Technical specifications

MODEL			PAC-LV11-E
Power			A single-phase, 220-240VAC 50Hz
Compatible Family series residential indoor units			MSZ-EF, MSZ-LN, MSZ-SF, MSZ-KJ
Number of branches			1 way
Maximum distance between indoor unit and LEV Kit	m		15
Compatible CITY MULTI outdoor units			Small Y Line - Small Y Compact Line - Y Lines (Ecostandard/ Standard Efficiency/High Efficiency) - Y Line Zubadan (YHM) - Y Line Replace Multi (YJM), R2 Lines (Standard Efficiency/High Efficiency) - R2 Line Replace Multi (YJM), WY Line (YHM) - WR2 Line (YHM)
Dimensions (HxLxW)	mm		180x355x142
Net weight	kg		3.5
Condensate drain			Not necessary
Installation			Vertical Horizontal
Refrigeration pipe diameter	Liquid	mm	6.35 (brazed)
	Gas	mm	-
Compatible remote controls			Standard: Remote control included with optional residential indoor units (purchased separately): 1. MA wired remote control interfaced via MAC-397IF board (optional, for installation in indoor units - purchased separately). 2. ME wired remote control, interfaced via LEV Kit terminal board.

PFFY-P VKM-E

INDOOR UNITS - Design floor-standing unit



CITY MULTI

Ideal for...

A high performance floor-standing air conditioner unit with an **elegant design** for lounges, bedrooms or offices where style is imperative.

Sophisticated design

A floor-standing air conditioner unit by Mitsubishi Electric boasting an innovative design and combining simple, linear lines with a wide choice of functions. Conceived to leave the walls free, a unit that delivers comfortable cooling performance in summer and pleasant heat in winter. The gloss pure white finish lends the unit a premium look suitable for any interior space. Both the upper and lower air vents are closed when the air conditioner is switched off, giving the unit an elegantly stylish feel. A beautifully stylish and innovative air conditioner from Mitsubishi that suits your most elegant interior spaces to perfection.

Slim but powerful

The slimline housing of the unit expresses the essence of compactness. The ideal size for a lounge, bedroom and many other rooms. The front panel is removable and washable, making the unit extremely simple to clean. Cleaning your air conditioner simply and regularly will keep it looking great and working perfectly for maximum energy efficiency.

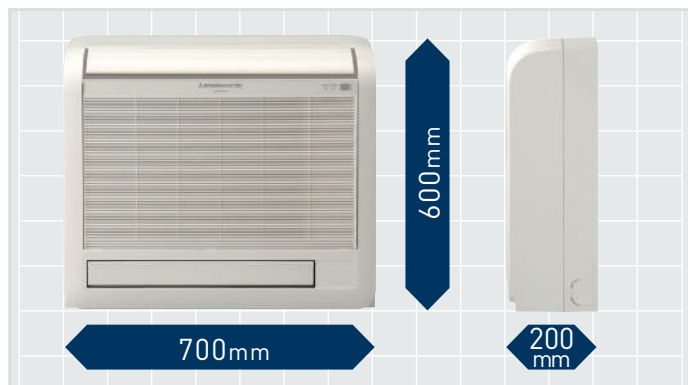

Ideal air distribution

Air is distributed powerfully and effectively via the upper and lower air vents, ensuring a comfortable temperature throughout the room. The angle of the upper vent is settable into 5 different positions (+ swing and automatic modes) from a remote control, while 4 different air speed settings are available. Setting the vane to an almost vertical position prevents undesirable draughts, for even greater comfort.



The air delivered from the upper and lower vents is controlled for optimum comfort and distributed evenly into every corner of the room. In heating mode, the warm air flow is controlled intelligently to reach floor level, making cold feet a thing of the past!

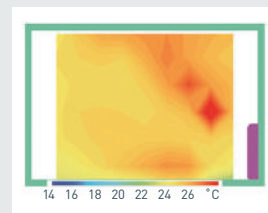



Key Technologies

Technical specifications

MODEL			PFFY-P20VKM-E	PFFY-P25VKM-E	PFFY-P32VKM-E	PFFY-P40VKM-E
Power			A single-phase, 220-240V 50Hz			
Capacity in cooling mode*1		kW	2.2	2.8	3.6	4.5
		Btu/h	7500	9600	12300	15400
Capacity in heating mode*1		kW	2.5	3.2	4.0	5.0
		Btu/h	8500	10900	13600	17100
Power consumption	Cooling	kW	0.025	0.025	0.025	0.028
	Heating	kW	0.025	0.025	0.025	0.028
Current	Cooling	A	0.20	0.20	0.20	0.24
	Heating	A	0.20	0.20	0.20	0.24
External finish			Plastic (pure white)			
Dimensions HxLxW		mm	600x700x200	600x700x200	600x700x200	600x700x200
Net weight		kg	15	15	15	15
Heat exchanger			Cross fins (aluminium fins and copper piping)			
Fan	Type x Quantity		Linear flow fan x 2			
	Air flow (low-medium-high-extra high)	m³/min	5.9-6.8-7.6-8.7	6.1-7.0-8.0-9.1	6.1-7.0-8.0-9.1	8.0-9.0-9.5-10.7
	Static external pres.	Pa	0	0	0	0
Motor	Type		DC motor			
	Power output	kW	0.03x2	0.03x2	0.03x2	0.03x2
Air filter			Polypropylene honeycomb fabric (catechin filter)			
Refrigerant pipe diameter	Gas (swaged)	mm	ø12.7	ø12.7	ø12.7	ø12.7
	Liquid (swaged)	mm	ø6.35	ø6.35	ø6.35	ø6.35
Local drain pipe diameter			D.I. 16 (PVC pipe connectable to VP-16)			
Sound pressure (low-medium-high)*2		dB(A)	27-31-34-37	28-32-35-38	28-32-35-38	35-38-42-44

*1 For heating/cooling capacity, the maximum value with the unit operating in the following conditions is given.

Cooling: indoor 27°C (81°F) DB/19°C (66°F) WB, outdoor 35°C (95°F) DB. Heating: indoor 20°C (68°F) DB, outdoor 7°C (45°F) DB/6°C (43°F) WB.

*2 Measured in anechoic chamber.

PFFY-P VLEM-E

INDOOR UNITS - Floor standing unit

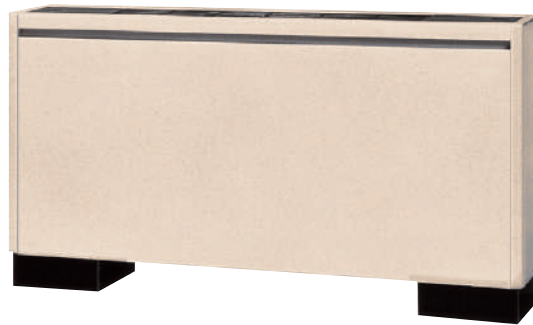

CITY MULTI

Ideal for...

A free floor standing **unit ideal for perimeter zones**. A compact unit for easy conditioning even in the perimeter area. The 220mm deep body (8-11 / 16in.)

Can be easily installed in the perimeter area to achieve effective conditioning in this area as well.

Compact unit

A compact unit offering a simple solution for conditioning perimeter zones. The compact unit, measuring just 220 mm in depth (8-11/16"), is easily installable in perimeter areas to ensure effective conditioning performance in these zones too.

Cooling dehumidification function

The electronic dehumidifier function uses cooling to dehumidify the air. The compact unit, measuring just 220 mm in depth, is easily installable in perimeter areas to ensure effective conditioning performance in these zones too.

Characteristics of PFFY-P VLEM-E

- Standardised design with simple lines.
- Suitable for all spaces, from offices and shops to hospitals.
- May be equipped with a water vapour impermeable membrane humidifier system.
- Features a specific concealed housing for stowing a remote control unit out of sight.

REMOTE CONTROLLER CAN BE BUILT-IN

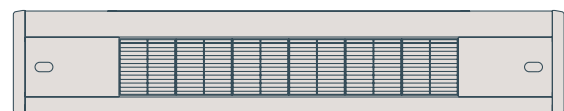

MA remote controller PAR-33MAA(G) can be installed.

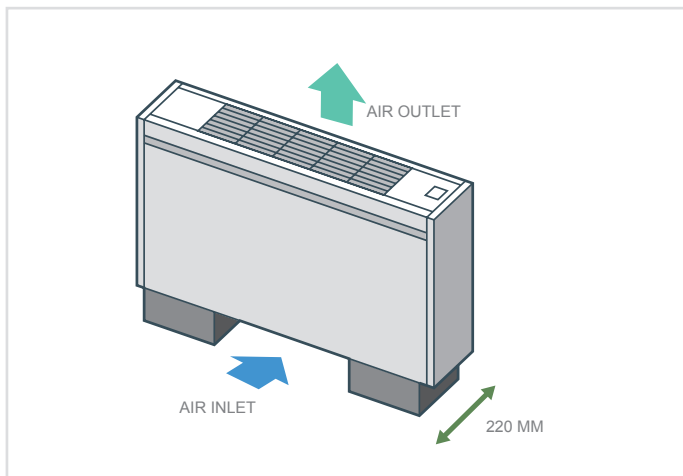



Key Technologies

Technical specifications

MODEL			PFFY-P20VLEM-E	PFFY-P25VLEM-E	PFFY-P32VLEM-E	PFFY-P40VLEM-E	PFFY-P50VLEM-E	PFFY-P63VLEM-E
Power			A single-phase, 220-240V, 50Hz / a single-phase, 208-230V, 60Hz					
Capacity in cooling mode*1		kW	2.2	2.8	3.6	4.5	5.6	7.1
		Btu/h	7500	9600	12300	15400	19100	24200
Capacity in heating mode*1		kW	2.5	3.2	4.0	5.0	6.3	8.0
		Btu/h	8500	10900	13600	17100	21500	27300
Power consumption	Cooling	kW	0.04 / 0.06	0.04 / 0.06	0.06 / 0.07	0.065 / 0.075	0.085 / 0.09	0.1 / 0.11
	Heating	kW	0.04 / 0.06	0.04 / 0.06	0.06 / 0.07	0.065 / 0.075	0.085 / 0.09	0.1 / 0.11
Current	Cooling	A	0.19 / 0.25	0.19 / 0.25	0.29 / 0.30	0.32 / 0.33	0.40 / 0.41	0.46 / 0.47
	Heating	A	0.19 / 0.25	0.19 / 0.25	0.29 / 0.30	0.32 / 0.33	0.40 / 0.41	0.46 / 0.47
External finish			Acrylic paint (5Y 8/1)					
Dimensions HxLxW		mm	630x1050x220	630x1050x220	630x1170x220	630x1170x220	630x1410x220	630x1410x220
Net weight		kg	23	23	25	26	30	32
Heat exchanger			Cross fins (aluminium fins and copper piping)					
Fan	Type x Quantity		Sirocco x 1	Sirocco x 1	Sirocco x 1	Sirocco x 2	Sirocco x 2	Sirocco x 2
	Air flow	m³/min	5.5-6.5	5.5-6.5	7.0-9.0	9.0-11.0	12.0-14.0	12.0-15.5
		l/s	92-108	92-108	117-150	150-183	200-233	200-258
		cfm	194-230	194-230	247-318	318-388	424-494	424-547
Static external pres.	Pa	0	0	0	0	0	0	
Motor	Type		Single-phase induction motor					
	Power output	kW	0.015	0.015	0.018	0.030	0.035	0.050
Air filter			Polypropylene honeycomb fabric (washable)					
Refrigerant pipe diameter	Gas (swaged)	mm	ø12.7	ø12.7	ø12.7	ø12.7	ø12.7	ø15.88
	Liquid (swaged)	mm	ø6.35	ø6.35	ø6.35	ø6.35	ø6.35	ø9.52
Local drain pipe diameter			D.I. 26 (1) <Accessory pipe O.D. 27 (upper end: O.D. 20)>					
Sound pressure*2*3*4		dB(A)	34-40	34-40	35-40		38-43	40-46

*1 For heating/cooling capacity, the maximum value with the unit operating in the following conditions is given.

Cooling: indoor 27°C (81°F) DB/19°C (66°F) WB, outdoor 35°C (95°F) DB. Heating: indoor 20°C (68°F) DB, outdoor 7°C (45°F) DB.

*2 Air flow/noise levels given for operation in low-high modes.

*3 Measurement point: 1m x 1m, Power: 240V AC/50Hz:

1dB(A) less with 230V AC/50Hz.

2dB(A) less with 220V AC/50Hz.

3dB(A) less with measurement point at 1.5 m x 1.5 m.

*4 Measured in anechoic chamber.

PFFY-P VCM-E

INDOOR UNITS - Floor standing concealed

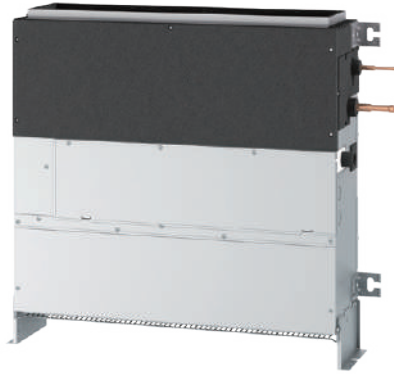

CITY MULTI

Ideal for...

Built-in floor units: simplified installation for effective air conditioning performance.

Flexible air-flow and external static pressure setting

The VCM series may be configured with a choice of four different static external pressure settings: 0, 10, 40 and 60 Pa. Besides airflow rate can be selected from 3 patterns (Low-Mid-High).

Reduced power consumption and noise

New structure realizes smoother airflow to reduce pressure loss in air pathway. The combination of an improved air pathway structure and components contributes to reduce power consumption and operation noise.

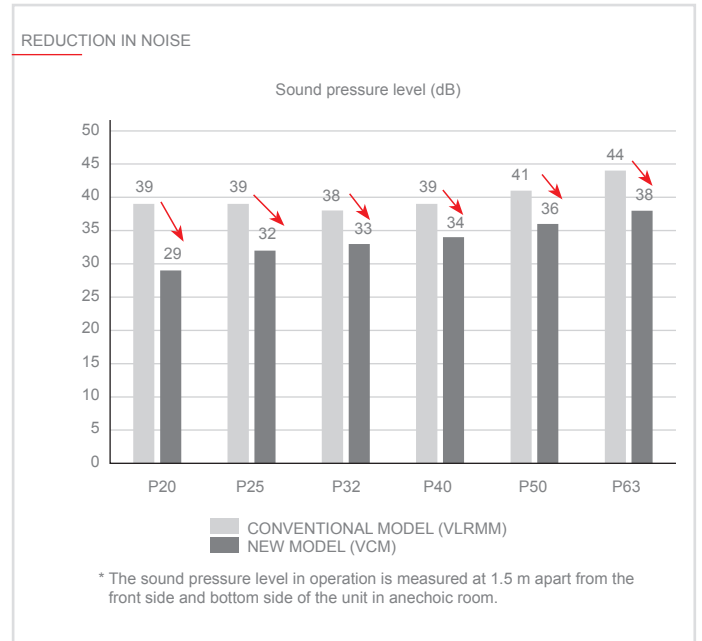
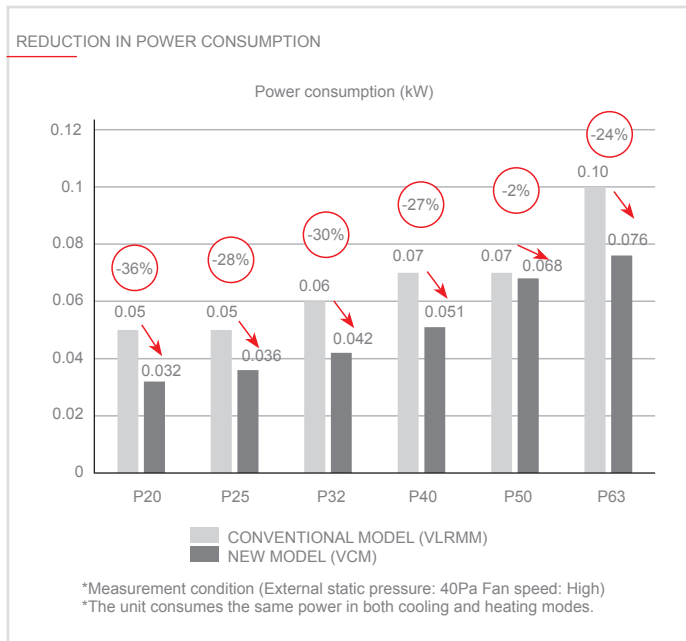



Key Technologies VCM

FLEXIBLE INSTALLATION

Selectable air inlet pattern

It is selectable bottom suction or front suction by changing panel, fan guard and filter.

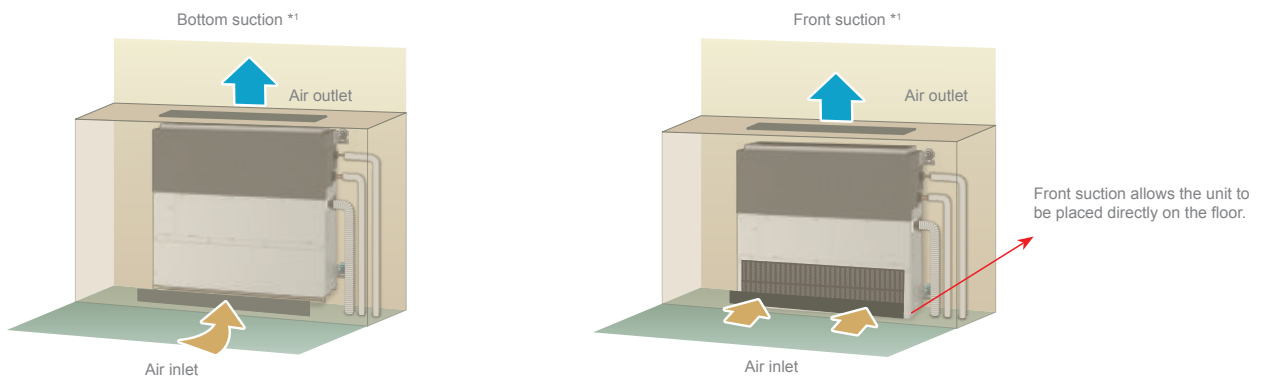

*1 Select a site where the flow of supply and air is not blocked. This unit cannot be placed directly on the floor with bottom suction.

*2 Unit with front suction makes noise than that with bottom suction. It is recommended that the bottom suction to be selected when installing the units in rooms that should be quiet, such as bedrooms.

Floor-standing with legs

The unit can be placed on the floor with the supplied legs.

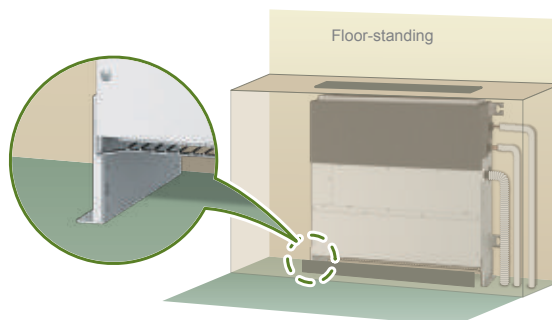

*Height of unit (with legs) is 690 mm.

Technical specifications

MODEL		PFFY-P20VCM-E	PFFY-P25VCM-E	PFFY-P32VCM-E	PFFY-P40VCM-E	PFFY-P50VCM-E	PFFY-P63VCM-E	
Power		A single-phase, 220-240V, 50Hz / a single-phase, 208-230V, 60Hz						
Capacity in cooling mode*1	kW	2.2	2.8	3.6	4.5	5.6	7.1	
	Btu/h	7,500	9,600	12,300	15,400	19,100	24,200	
Capacity in heating mode*1	kW	2.5	3.2	4.0	5.0	6.3	8.0	
	Btu/h	8,500	10,900	13,600	17,100	21,500	27,300	
Power consumption*2	Cooling kW	0.022	0.026	0.031	0.038	0.052	0.058	
	Heating kW	0.022	0.026	0.031	0.038	0.052	0.058	
Current*2	Cooling A	0.25	0.30	0.34	0.38	0.50	0.49	
	Heating A	0.25	0.30	0.34	0.38	0.50	0.49	
External finish		Galvanized steel plate						
Dimensions HxLxW*3	mm	615(690)x700x200	615(690)x700x200	615(690)x700x200	615(690)x900x200	615(690)x900x200	615(690)x1,100x200	
Net weight	kg	18	18	18.5	22.5	22.5	25.5	
Heat exchanger		Cross fin (aluminium fin and copper piping)						
Fan	Type x Quantity	Sirocco x 2	Sirocco x 2	Sirocco x 2	Sirocco x 3	Sirocco x 3	Sirocco x 4	
	Air flow	(Low-Mid-High)						
		m ³ /min	5.5-6.0-7.0	5.5-6.5-8.0	5.5-7.0-8.5	8.0-9.5-11.0	10.0-11.5-13.5	12.0-14.0-16.5
		l/s	83-100-117	92-108-133	92-117-142	133-158-183	167-192-225	200-233-275
Static external pres.	Pa	<0> - 10 - <40> - <60>	<0> - 10 - <40> - <60>	<0> - 10 - <40> - <60>	<0> - 10 - <40> - <60>	<0> - 10 - <40> - <60>	<0> - 10 - <40> - <60>	
Motor	Type	DC motor						
	Power output kW	0.096	0.096	0.096	0.096	0.096	0.096	
Air filter		Polypropylene honeycomb fabric (washable)						
Refrigerant pipe diameter	Gas (brazed) mm	ø12.7	ø12.7	ø12.7	ø12.7	ø12.7	ø15.88	
	Liquid (brazed) mm	ø6.35	ø6.35	ø6.35	ø6.35	ø6.35	ø9.52	
Field drainpipe diameter		O.D. 32 (1-1/4)						
Sound pressure*2	dB(A)	21-23-26	22-25-29	23-26-30	25-27-30	28-31-34	28-32-35	

*1 For heating/cooling capacity, the maximum value with the unit operating in the following conditions is given.

Cooling: indoor 27°C (81°F) DB/19°C (66°F) WB, outdoor 35°C (95°F) DB. Heating: indoor 20°C (68°F) DB, outdoor 7°C (45°F) DB/6°C (43°F) WB.

*2 The values are measured at the factory setting of external static pressure (10 Pa).

*3 The values in () show the height of unit with leg.





HVRF hydronic systems

Y Line

R32 HVRF Packaged Hydronic systems Heat Pump

The HVRF Y packaged hydronic system is a new hydronic solution on heat pump version that consists of a water production section composed of a VRF technology Outdoor Unit Y CITY MULTI and a hydronic unit for water distribution. The system is completed by different types and sizes of hydronic terminals, that can be regulated locally. All components of the hydronic system are branded Mitsubishi Electric. HVRF hydronic systems are derived from VRF and as such bring with them the advantages of a simplified design and sizing defined by Mitsubishi Electric rules. HVRF Y systems are environmentally friendly with an important reduction of CO₂ equivalent, thanks to the use of R32 refrigerant gas, with low GWP.



HVRF Y LINE

HYDRONIC UNIT

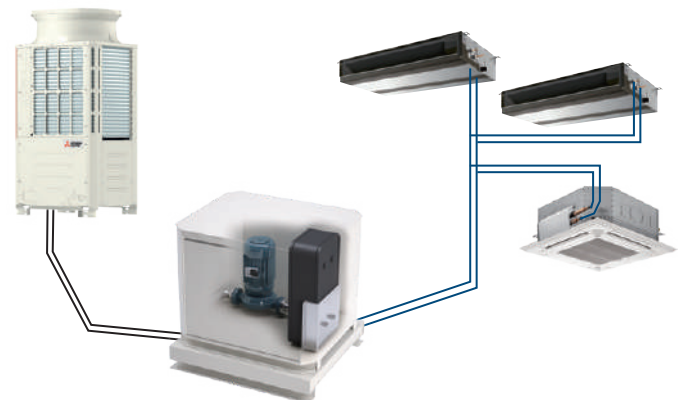



R2/WR2 Line

R410A

HVRF packaged hydronic heat pump systems

The HVRF R2 packaged hydronic heat recovery system is a technology based on Mitsubishi Electric's CITY MULTI R2 two-pipe system for simultaneous cooling and heating with heat recovery.

It consists of an R2 (or WR2) outdoor unit of the CITY MULTI series, the innovative Hydronic BC (HBC) distributor which allows the use of refrigerant gas and water as refrigerator fluids, as well as indoor units specially equipped with a water coil.

HVRF hydronic systems are derived from VRF and as such bring with them the advantages of a simplified and guided design in the sizing of all components.



The use of hydronic distribution allows for an up to 45% reduction in refrigerant compared to a traditional VRF system. HVRF R2 systems have a low environmental impact with an important reduction in CO₂ equivalent.

HVRF R2 LINE

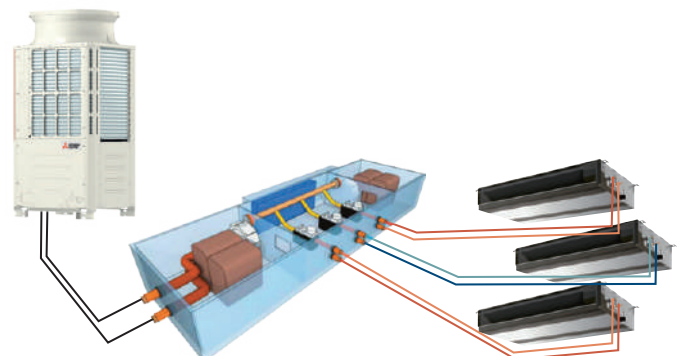

HYDRONIC HBC CONTROLLER



	CITY MULTI Y SYSTEMS	Heat pump systems with continuous heating
	CITY MULTI R2 SYSTEMS	Simultaneous two-pipe cooling/heating systems with heat recovery and continuous heating.
	CITY MULTI WR2 SYSTEMS	Heat recovery systems with water condensation/evaporation.

Outdoor units	8	10
	M200	M250
Model	WM250	
HYDRONIC UNIT CMH-WM V-A		
	same external dimensions/different internal structures depending on capacity	

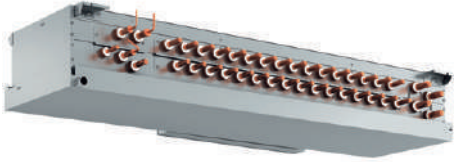
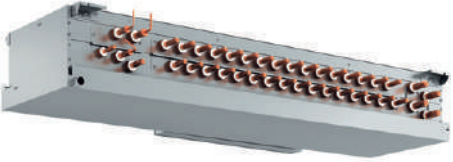
Type of HBC	Main	
Model	CMB-WM108V-AA	CMB-WM1016V-AA
Number of connections	8	16
HYDRONIC BC CONTROLLER HBC		

	<p>SINGLE Y PUHY-M YNW-A1 (-BS) - HP 8~20</p>
	<p>SINGLE R2 PURY-P YNW-A1(-BS) - HP 8~20</p>
	<p>SINGLE WR2 PQRY-P YLM-A1 - HP 8~20</p>

12	14	16	18	20
M300	M350	M400	M450	M500
WM350			WM500	
				
<p>same external dimensions/different internal structures depending on capacity</p>				

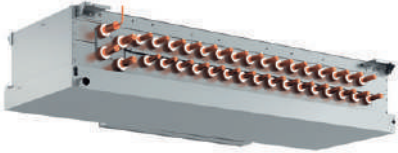
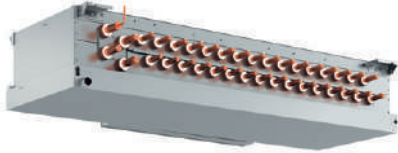
Sub	
CMB-WM108V-AB	CMB-WM1016V-AB
8	16
	

Sistem					HP	4,5	
					Model	P112	
Air-cooled	HVRF Heat pump	Y Line Heat Pump	PUHY-M YNW-A1 (-BS)		SINGLE		
					DOUBLE		
					TRIPLE		
	HVRF Heat recovery	R2 Line Heat Pump	PURY-P YNW-A1(-BS)		SINGLE		
					DOUBLE		
Water-cooled	HVRF Heat recovery	WR2 Line Heat recovery	PQRY-P YLM-A1		SINGLE		
					DOUBLE		

	5	6	8	10	12	14	16	18	20
	P125	P140	P200	P250	P300	P350	P400	P450	P500
			8	10	12	14	16	18	20
			8	10	12	14	16	18	20
			8	10	12	14	16	18	20



Key Technologies

Mitsubishi Electric: state of the art technology and continuous pursuit of improvement. Quality, innovation and performance of HYDRONIC VRF CITY MULTI systems.

Technology



Lower concentration of GAS

Lower concentration of refrigerant in the building and confined only in the section between the Outdoor Unit and the Hydronic Unit/Hydronic Branch Controller.



High SHF (Sensible Heat Factor) cooling

Thanks to HYDRONIC VRF technology it is possible to design systems with typical VRF simplicity and higher confort thanks to the use of water as heat carrier. Mitsubishi Electric water-fed indoor units grant a really stable temperature control, with higher Sensible Heat Factor (SHF) than traditional direct expansion systems. *re rispetto ad un sistema ad espansione diretta tradizionale.*



Reduced defrost and transitory time

Using water as heat carrier also gives an additional advantage during heating periods, reducing defrost time. Thanks to water thermal inertia it is possible to resume releasing heat to the environment just after a defrost cycle, minimizing the system turn-off periods.



Silent functioning with water cooled units

Indoor units of the HYDRONIC VRF are equipped with water-fed heat exchangers. The lack of LEV valve in the units grants a very silet functioning regime, particularly suited for “sensible” environments such as libraries, schools, bedrooms.



Modular system for fractionate and progressive installation

HYDRONIC VRF system is particularly suited for designs which require partial installation or applications catattered by fractionated realization schedule. This often occurs in real-estate of commercial/residential buildings intended for different type of users, which are often sold/realized separately.



Modulating regulation of the pump based on the load and capacity required

The new HYDRONIC VRF system contains all the components necessary for the distribution and regulation typical of a hydronic system. Thanks to the presence of two variable speed circulators (inverters), the HVRF system is able, in total autonomy, to regulate the flow of water destined for the individual hydronic units (indoor units) according to the thermal load required by the individual rooms.



M-NET control system

Being part of the CITY MULTI family, even the HYDRONIC VRF system can use the control and communication systems (M-Net) of the VRF systems and consequently can benefit from the M-NET Power function which allows the system to continue to operate normally even in the event of a power failure of one or more indoor units. This function is particularly advantageous and effective in all those cases in which the air conditioning system is shared between several users (shopping centre, condominium, etc.).



Valves, pumps, exchangers and integrated control and regulation systems

The innovative HYDRONIC VRF distributor is the only device in the world that uses refrigerant gas and water as carrier fluids thanks to special plate heat exchangers. Inside it there are all the components necessary for the distribution and regulation of the water flow to the individual indoor units. The presence of two plate heat exchangers allows the system to always be ready to produce hot and cold water at the same time; supply and return manifolds, water flow regulation valves and two variable flow pumps allow the system to independently manage the hydronic distribution to the individual indoor units based on a complex series of parameters acquired by the same system.



Accessories and safety devices

When installing the HYDRONIC VRF system, it will be sufficient to provide for

- 20 mm diameter copper or multilayer piping
- Expansion vessel to be connected directly to the HBC Controller
- Supply line (water load) equipped with shut-off valve, safety valve, filter, pressure reducer
- Condensate drain line
- 220V power supply line

Compressor NEXT STAGE GENERATION

The compressor, known as the heart of the air conditioner, has been newly developed. A new centrifugal force canceling mechanism and a new multi-port mechanism have been developed. In addition, we have mounted a high-efficiency motor. The synergetic effect of these new technologies increases the compressor performance and efficiency, and also helps to improve the performance of the outdoor unit.



Centrifugal force canceling mechanism (8 to 14HP)

The structure of the scroll compressor causes a centrifugal force during operation. Conventionally, that centrifugal force is applied onto the scroll section. This causes refrigerant to leak, and restricts the increase in rotational speed to a maximum of 120rps. With the new compressor, a new structure (centrifugal force canceling mechanism) has been mounted to suppress the centrifugal force. This mechanism successfully suppresses the centrifugal force generated at the scroll section, reduces refrigerant leakage losses, and increases the compressor efficiency. The maximum rotational speed has been increased from the conventional 120rps to 140rps.

This new mechanism also speeds up the start of operation, and enables operations such as preheat defrost operation and the smooth auto-shift startup mode.

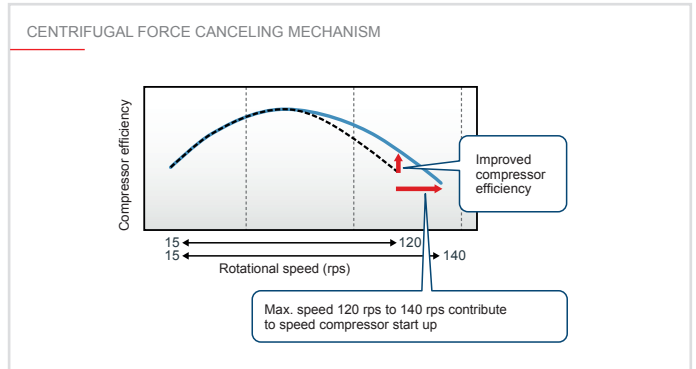
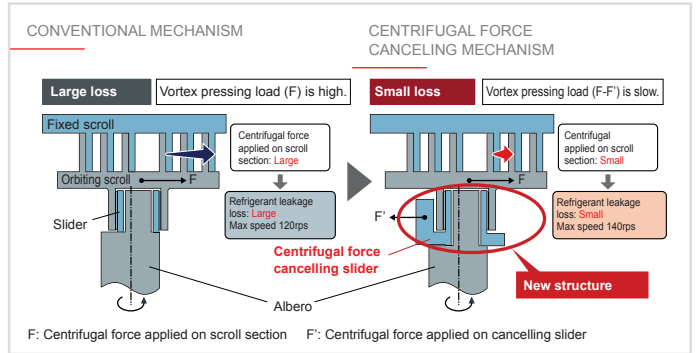

Multi-port mechanism

Efficient partial load operation is realised by avoiding over-compression. With the scroll compressor, the distance of the compression process in the scroll is usually fixed, so over-compression occurs during low loads and low rotation. The new compressor is equipped two sub-ports in addition to the conventional discharge port to reduce this over-compression loss during low loads. In operation conditions having a low compression rate, the distance in the compression process is kept short by that successfully avoiding unnecessary compression, and contributing to efficient partial load operation.

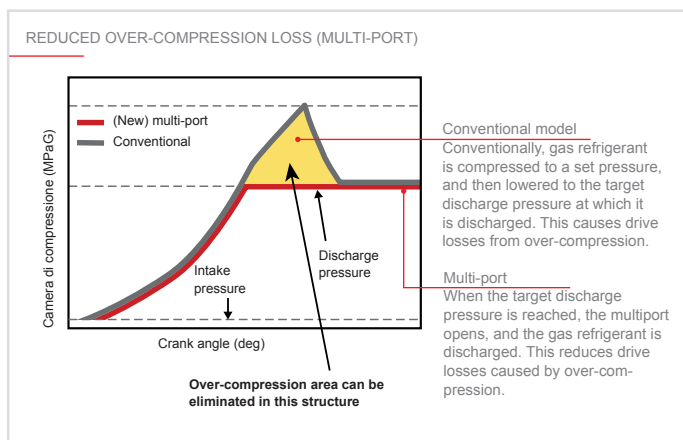
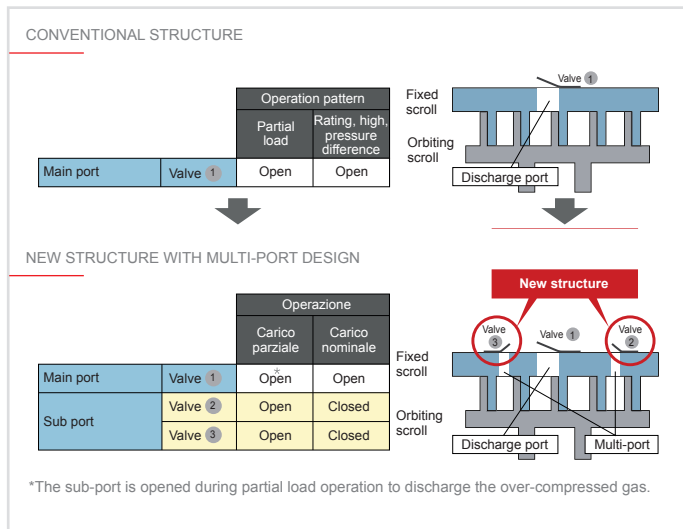

Improved high-efficiency motor

The insulator section that traditionally created a dead space is eliminated by insulating the motor's stator film. Since winding can be set in that section, the winding area can be increased by approx. 9%. The wire diameter has also been increased by two ranks, so the resistance between terminals is reduced, and the insulation distance is shorter. This improves the motor's operation performance and contributes to high-efficiency operation of the compressor.

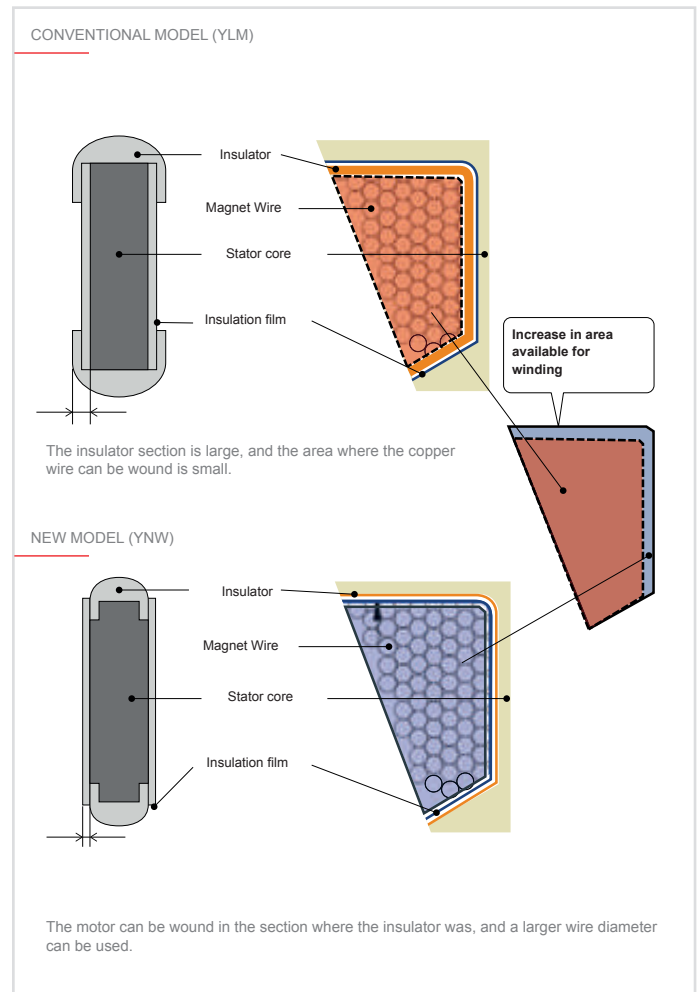



Inverter-driven compressor technology

All CITY MULTI compressors are of the inverter-driven type, capable of precisely matching a building's cooling and heating demands.

The compressor varies its speed to match the indoor cooling or heating demand and therefore only consumes the energy that is required. When an inverter driven system is operating at partial load, the energy efficiency of the system is significantly higher than that of a standard fixed speed, non-inverter system.

The fixed speed system can only operate at 100%, however, partial load conditions prevail for the majority of the time. Therefore, fixed speed systems cannot match the annual efficiencies of inverter driven systems. Using proven single inverter driven compressor technology, the CITY MULTI range is favored by the industry for low starting currents (just 8 amps for a 20HP outdoor unit) and smooth transition across the range of compressor frequencies.

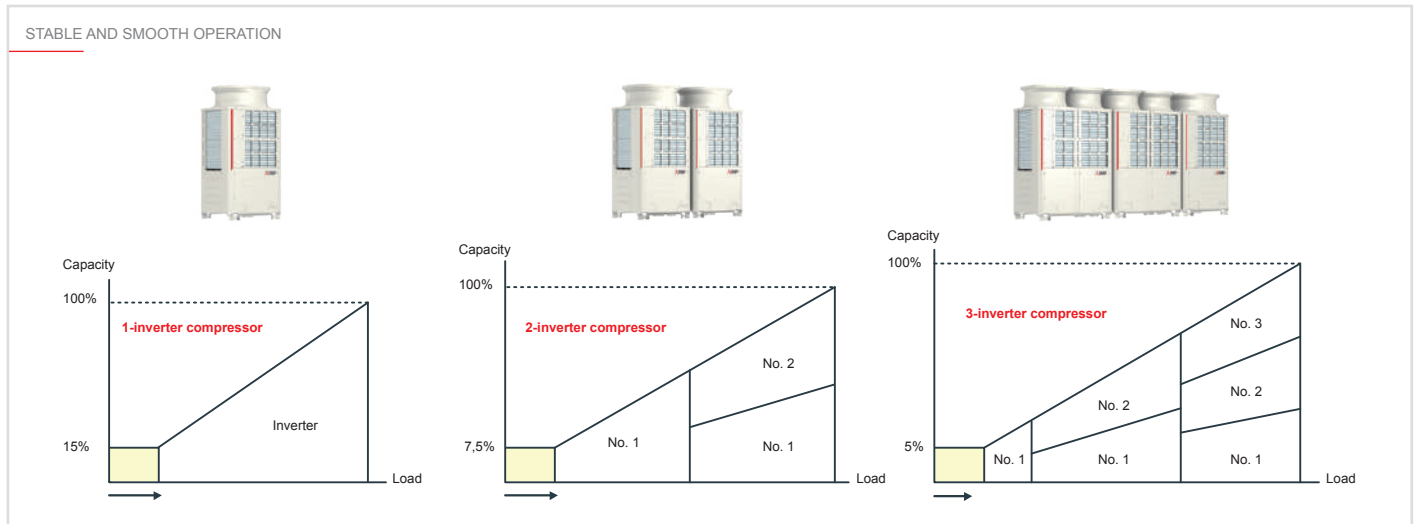
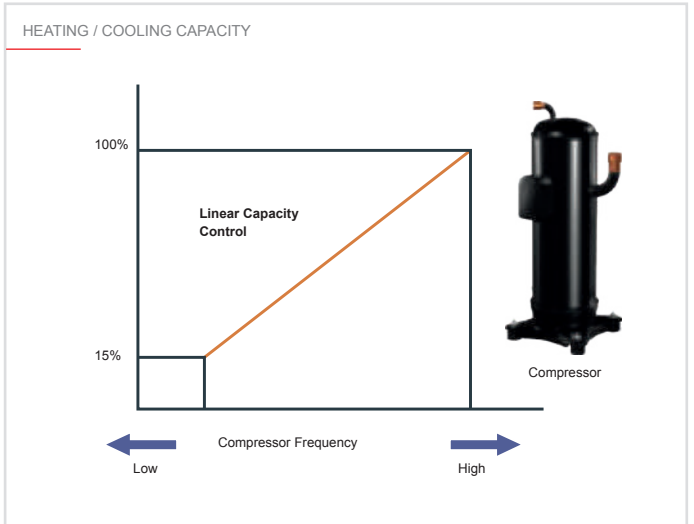

Functions

M-Net Power

With the M-Net transmission line and the use of separate power and control circuits for indoor units, the following states can be identified automatically:

- indoor unit malfunction
- power loss to indoor unit.

In the event of one of these conditions, the outdoor unit isolates the malfunctioning indoor unit or indoor unit receiving no power to ensure the continued electrical and refrigeration functionality of the system with no action required from a technician and/or a system administrator. This allows total flexibility in planning and laying out 220V AC power circuits, without the need for shared main lines and without requiring any additional devices to attain compliance with legislation for electrical systems. This circuit configuration is essential for situations where the system itself is shared by multiple owners or tenants, and where each must be able to electrically isolate their respective indoor terminal sections when required.

Continuous operation

In the event of power loss or partial malfunction of one or more indoor units, the system continues to function uninterruptedly and without requiring any action from a technician and/or system administrator.

Continuous heating operation

Normally, it is necessary to stop the heating operation during defrosting. However, the continuous heating operation method makes it possible to perform defrosting while the heating operation continues. Reduction in the stoppage time of the heating operation

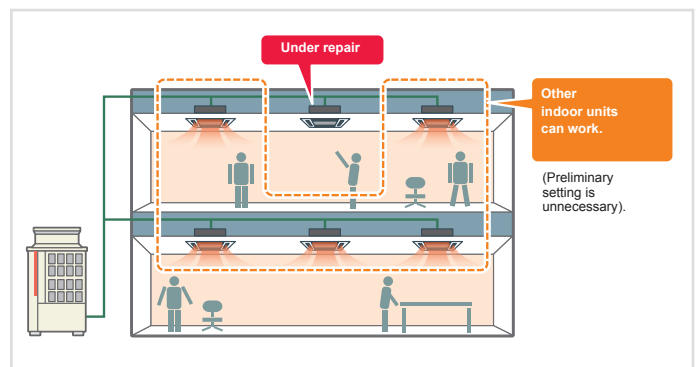
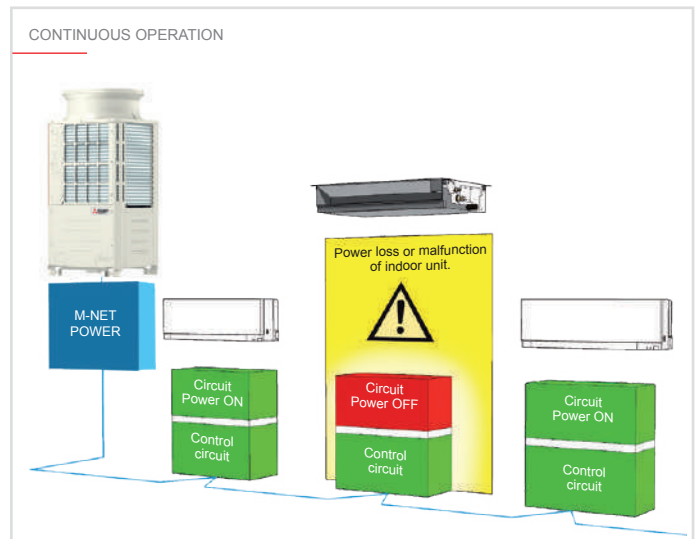

prevents drops in room temperature. Use a dip switch on the outdoor unit to switch between the continuous heating operation method and the conventional defrosting method.

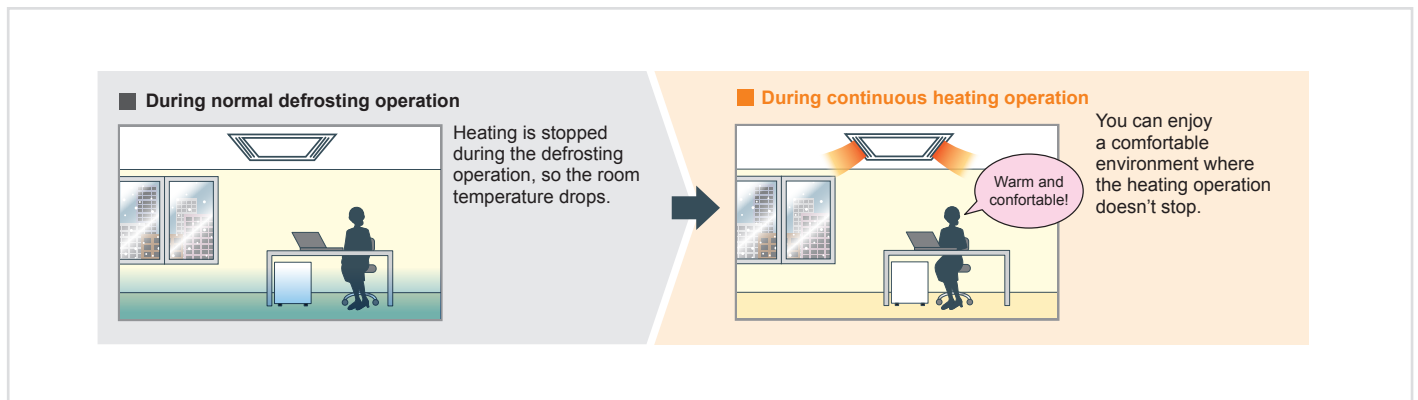

Continuous heating operation image (single unit)

The heat exchanger of the outdoor unit is split into parts. Even when defrosting is necessary, the heating operation is continued with a part of the heat exchangers.

Continuous heating operation image (combination)

With the combination model, units perform defrosting alternately. While one unit is performing defrosting, the other continues heating.

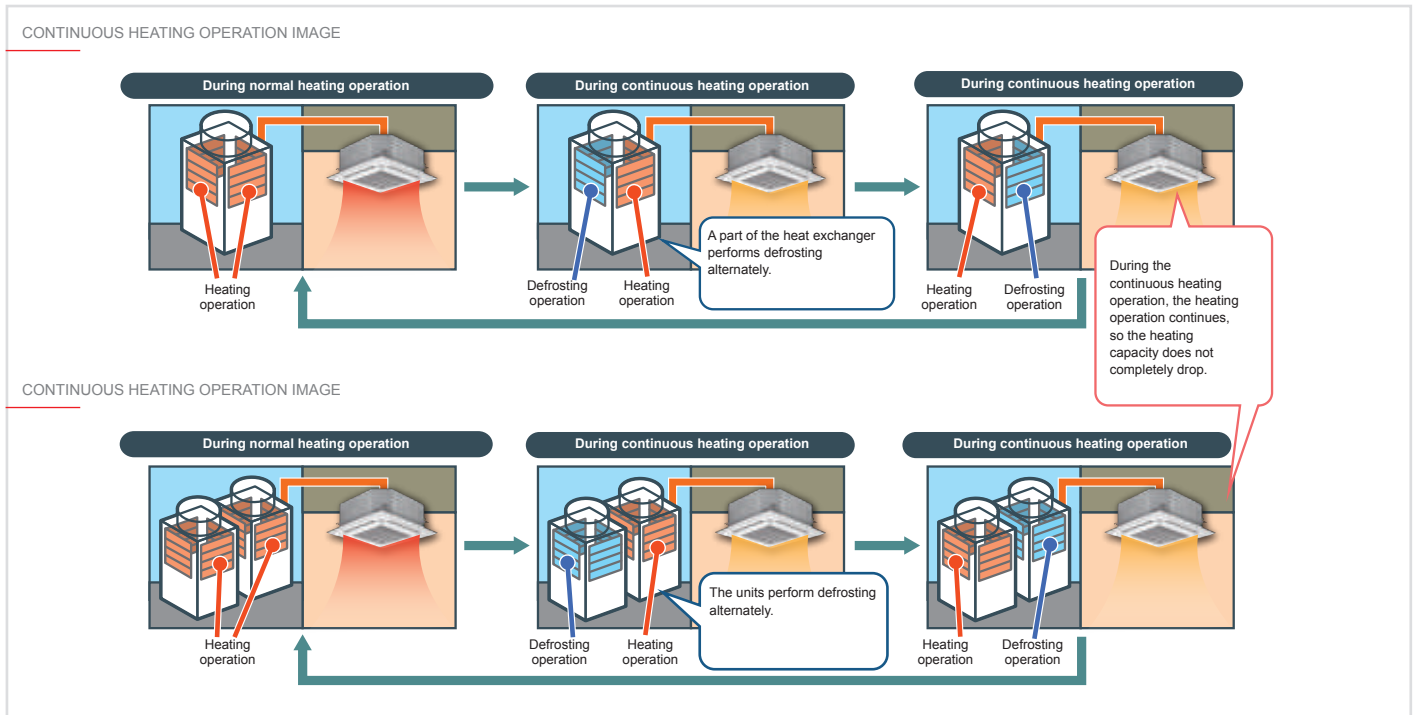

NEW Preheat Defrost Preheat defrost operation

The new outdoor unit is equipped with a preheat defrost operation that raises the discharge temperature of the air before beginning defrost operation. This contributes to raising the room temperature before the start of defrost operation and prevents room occupants experiencing a chilling sensation.

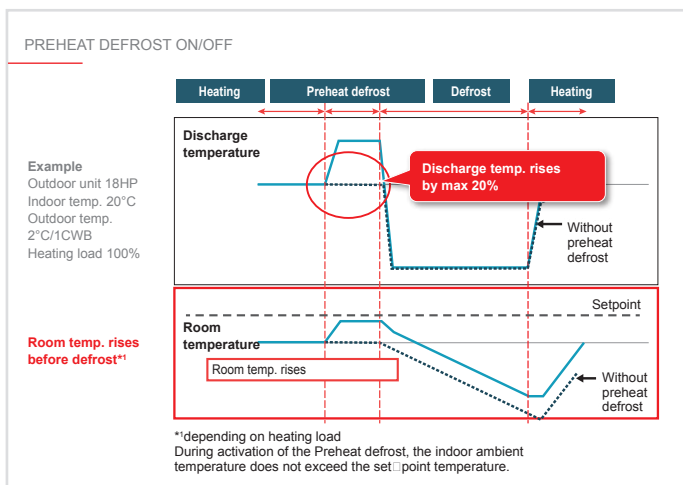

NEW Low Noise Flexible Noise Setting

The "Low Noise" mode, which conventionally only had one pattern, has been increased to four patterns so that a mode can be selected from a total of five patterns, including the rated pattern. The low-noise mode has four patterns 85%, 70%, 60% and 50% in respect to the fan speed. This can be set with the outdoor unit's DIP switch. The pattern can be selected according to the customer's requests when low-noise operation is required.

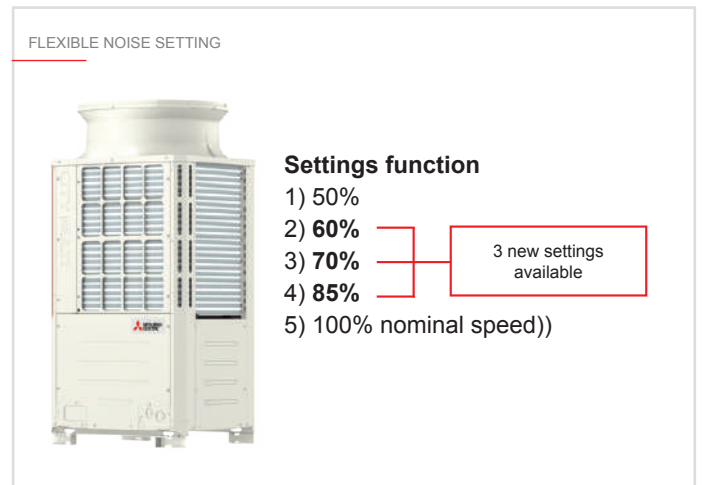



Energy efficiency control

Evaporating temperature control (during cooling)

In a traditional system, the evaporation temperature is kept constant regardless of the system load conditions. In low load conditions (when thermal loads to be dealt with are limited) increasing the evaporation temperature of the system decreases the compressor's workload and consequently limits the electrical absorption of the outdoor unit without affecting the environmental comfort level.

EVAPORATING TEMPERATURE CONTROL (DURING COOLING) NORMAL MODE

The evaporating temperature is kept constant regardless of the load. Even at low loads, the normal evaporating temperature does not change, which leads to energy losses during partial load operation.

SMART EVAPORATING TEMPERATURE CONTROL MODE

The evaporating temperature is increased and the compressor input is decreased according to the load, resulting in increased operating efficiency. There are two patterns to control the evaporating temperature as follows.

- 1) The evaporating temperature is controlled to be constant, regardless of the ΔT . The evaporating temperature is set to a value that is higher than the normal evaporating temperature.
- 2) The evaporating temperature is controlled by shifting it according to the ΔT . The user can select from 4 control patterns.

- * The availability of 1 and 2 varies depending on the model. Refer to the function table.
- * Changing the evaporating temperature reduces latent heat capacity. Select an appropriate pattern according to the installation conditions.

SUITABLE SITUATIONS

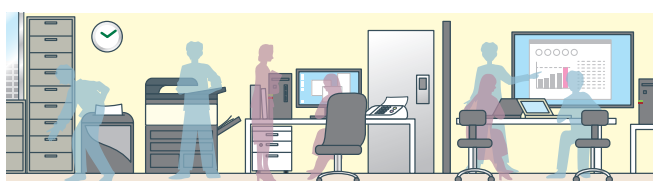

- Spaces with constant high temperatures from heat sources such as OA equipment
- When the load is low during periods when air conditioners are used for cooling (such as during the morning).

The new outdoor units are equipped with an evaporation temperature selection function, which automatically takes the system load conditions into account.

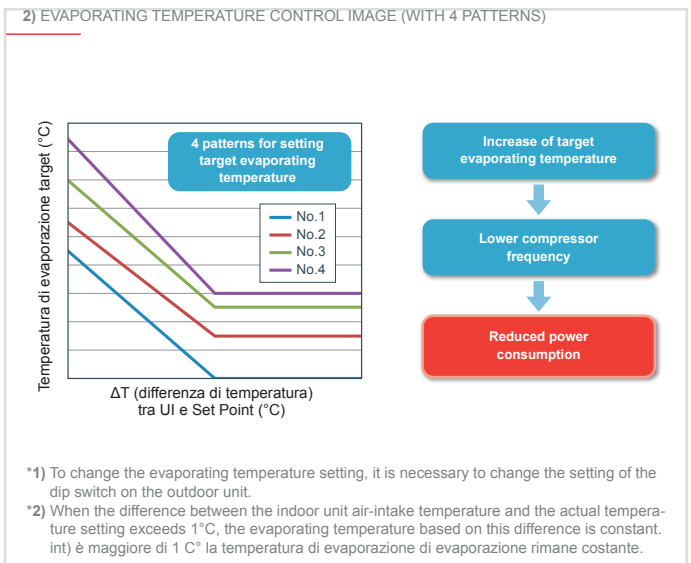
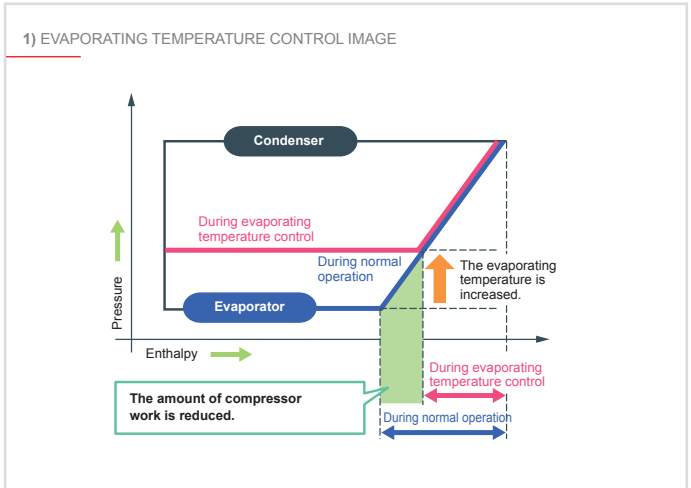

Compressor: new induction heating technology

The Y Line and R2 Line outdoor units employ a pre-heating system for the scroll compressor based on induction technology. This solution is used to warm the compressor housing to minimise energy absorption in stand-by state. Yet another solution contributing to reducing energy consumption.





High sensible heat

High sensible heat operation

The evaporating temperature is controlled according to room temperature and humidity, and refrigerant pressure.

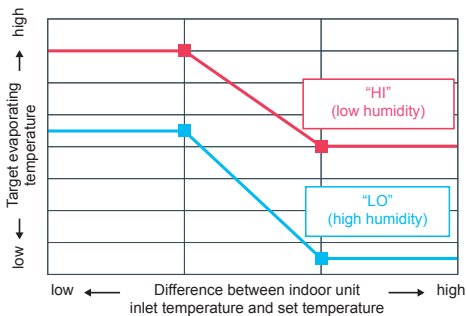

With high sensible heat operation mode activated, air conditioners consume less energy, thereby realizing cost savings. If a locally-procured humidity sensor is installed, the evaporating temperature of the outdoor unit can be controlled optimally as shown below according to the difference between the indoor unit inlet temperature and set temperature. A wide range of temperature settings are available, from a low evaporating temperature close to the temperature for normal operation to a high evaporating temperature to realize energy savings.

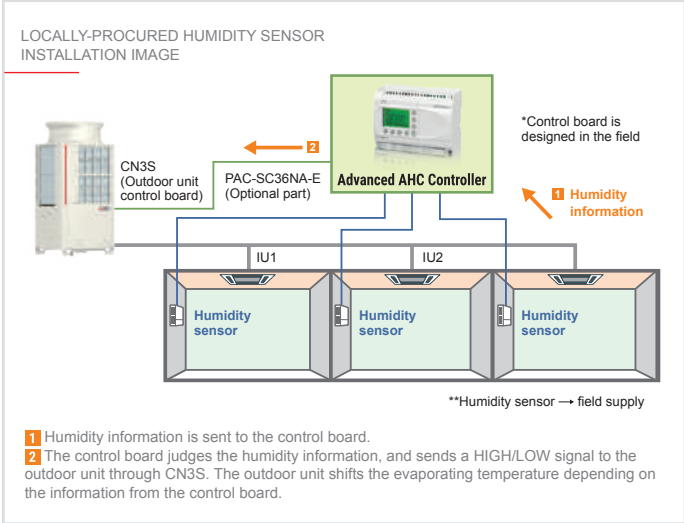

TEMPERATURE AND HUMIDITY CONDITIONS

	Room state	Condition of outdoor unit	Zone	Evaporating temperature control
<p>Comfortable temperature and humidity</p> <p>High sensible heat operation</p>	<p>Comfortable</p>	<p>Comfortable and energy-saving operation even at low compressor rotating speed</p>	<p>Umidity</p> <p>Temperature</p>	<p>Temperature of refrigerant in indoor unit kept high</p>
<p>High humidity</p>	<p>A little humid</p>	<p>Compressor rotating at medium speed to reduce humidity</p>	<p>Umidity</p> <p>Temperature</p>	<p>Temperature of refrigerant in indoor unit slightly reduced</p>
<p>High temperature and humidity</p>	<p>Uncomfortable</p>	<p>Compressor rotating at high speed to reduce temperature and humidity</p>	<p>Umidity</p> <p>Temperature</p>	<p>Temperature of refrigerant in indoor unit greatly reduced</p>



Dual Set Point

Normally, the desired room temperature is set to the same value for cooling and heating. However, the dual set point function makes it possible to set different temperatures for cooling and heating. When operation switches from cooling to heating or vice versa, the preset temperature changes accordingly.

Setting dual set points for the Auto mode on R2 and WR2 helps improve energy efficiency, compared to setting a single set point.

When the operation mode is set to the Auto (dual set point) mode, two preset temperatures (one each for cooling and heating) can be set. Depending on the room temperature, the indoor unit will automatically operate in either the Cool or Heat mode and keep the room temperature within the preset range. The outdoor unit does not operate in the dead band defined by two temperature points where the thermostat is off. This cuts down on unnecessary operation of the air conditioning system.

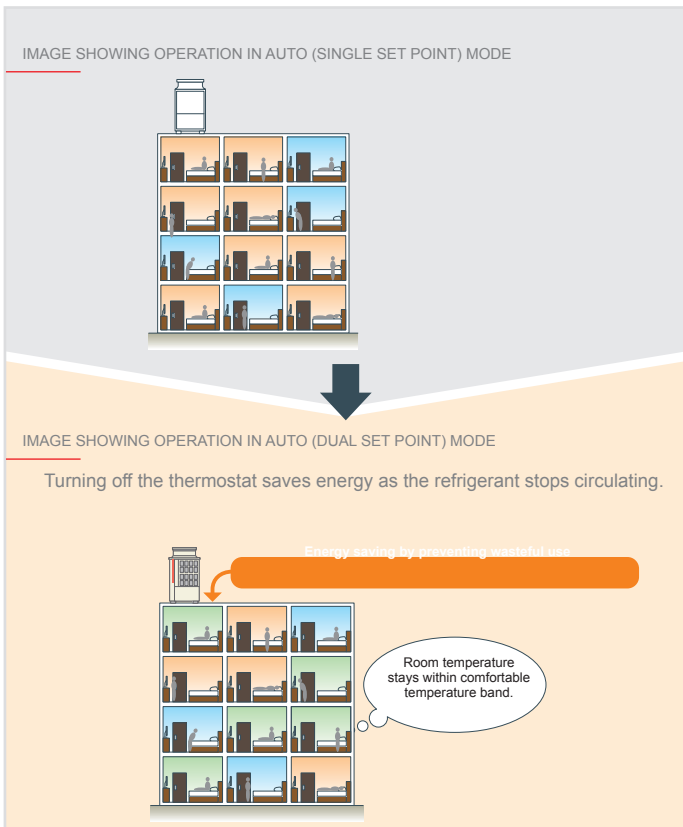
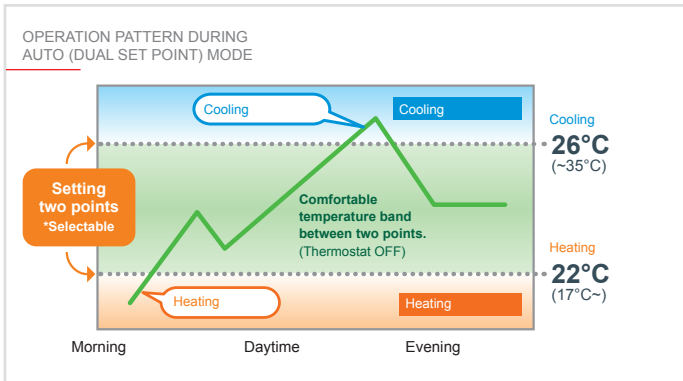

Heating operation Cooling operation Thermo OFF



Smooth auto-shift startup mode

Smooth auto-shift startup mode, a new operation mode on the outdoor unit, can now be selected in addition to the conventional COP Priority and Capacity Priority modes. In order to heat the room faster, Capacity Priority mode runs for 30 minutes when heating operation starts. The unit then switches to COP Priority mode to increase energy-saving efficiency. This enables both improved comfort and energy savings.

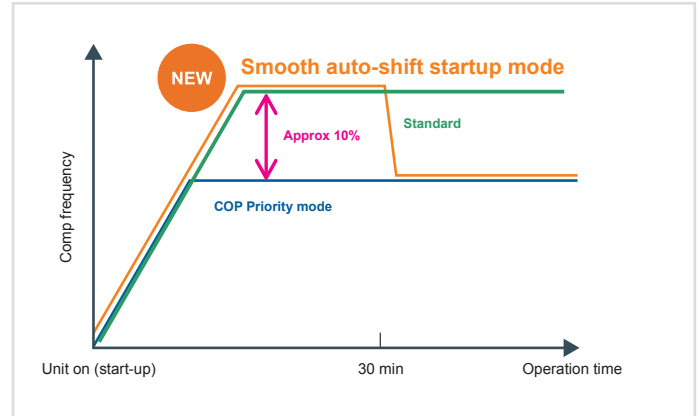

Installation and maintenance

R410A R407C Multi-refrigerant

The indoor units of VRF CITY MULTI systems are the first and only products on the market with multi-refrigerant capability. These units can operate with R22, R407C and R410A systems with no loss in performance, irrespective of the different pipe sizes. This allows unparalleled freedom for installation, as well as offering total reverse compatibility in the event of replacing indoor units with an R22 or R407C VRF CITY MULTI system.

NEW 80Pa Selectable external static pressure of the outdoor unit

The static pressure specification of the outdoor unit can be selected (0, 30, 60, or 80 Pa). This facilitates installation of the unit on each floor of a high-rise building or on balconies.

* The static pressure that can be set varies depending on the model.

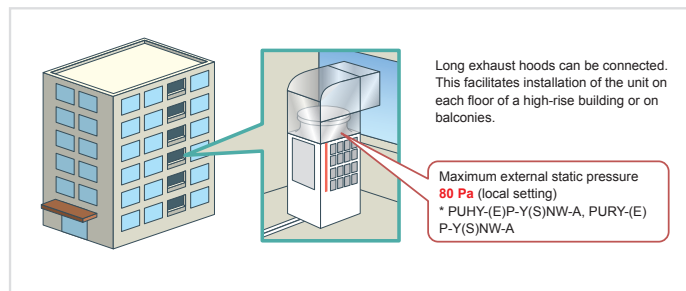

Intelligent Terminal Boards

Intelligent indoor unit terminal boards are a unique feature of Mitsubishi Electric VRF systems. These intelligent terminal boards make it possible to use the air conditioning system and the M-NET communication network, via the indoor units, as a vehicle for collecting, transferring and monitoring field signals from generic appliances such as lighting, power, access management, intelligent alarm systems etc. Using the intelligent terminal boards of the indoor units together with the existing infrastructure drastically reduces the number of cables needed to collect these field signals and the amount of labour required to route the cables to the centralized units. Typically, each indoor unit supports the following signals and functions:

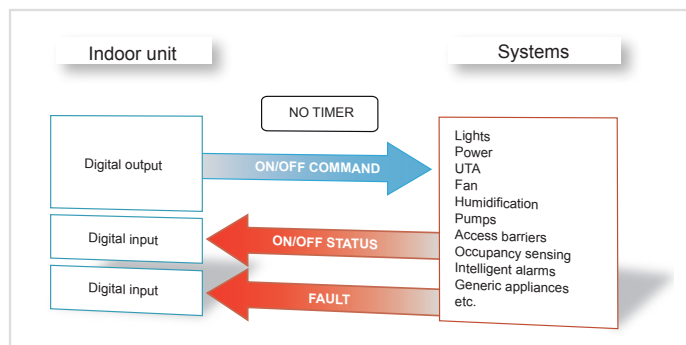

NEW Usable in an application with a large vertical separation of up to 90 meters

A height difference of up to 90 m from the outdoor unit to the indoor unit can be supported with no extra-cost options. This increases design flexibility and facilitates installation of these units even in high-rise buildings.

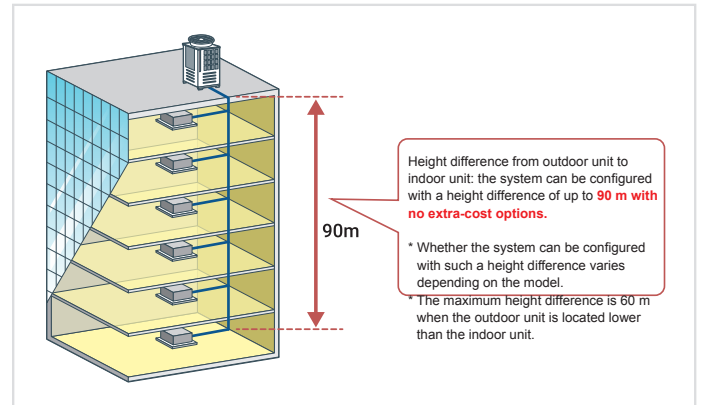

Self-diagnosis of VRF CITY MULTI system

For even simpler maintenance, CITY MULTI systems have a self-diagnostic function which is capable of communicating malfunctions on different levels using fault codes. With the special Maintenance Tool software developed by Mitsubishi Electric, the user can connect to any point in the transmission line to acquire all technical operating information interactively.



NEW USB Downloading operating data via USB

Operation data was retrieved from conventional models using the maintenance tool. On the new model, the data can be retrieved quickly via USB*1. It is unnecessary to carry the personal computer in which the maintenance tool has been installed, reducing field operation time and improving convenience. Software can be rewritten via USB, while data for up to 4 days and the 5 minutes after an error has occurred can be stored in the the USB memory device*2.

*1 In the case of OC-IC maximum configuration
*2 USB memory devices conforming to USB2.0 can be used.





HVRF System Line

Heat pump systems

HVRF Y Systems

HEAT PUMP

170

Hydronic unit

172

HVRF Y System architecture

174

System Components

AIR-COOLED

PUHY-M YNW-A1 (-BS)

176

HYDRONIC UNIT

CMH-WM V-A

178

Design guide

179



HYDRONICVRF



HVRF Hydronic Systems

Heat Pump



Complete system

HVRF Y systems are based on a modular concept and a complete solution of Mitsubishi Electric branded products.

All system components: Outdoor Units, Hydronic Units, Indoor Units, Control Systems are native to Mitsubishi Electric and communicate with each other through the "M-Net" communication system.

The regulation of HVRF systems is also Mitsubishi Electric unlike traditional Hydronic systems.

Less refrigerant required

The hydronic unit creates a separation between the area delimited by the refrigerant and the area delimited by the water fluid, limiting the amount of refrigerant that was measured to be around 61%.

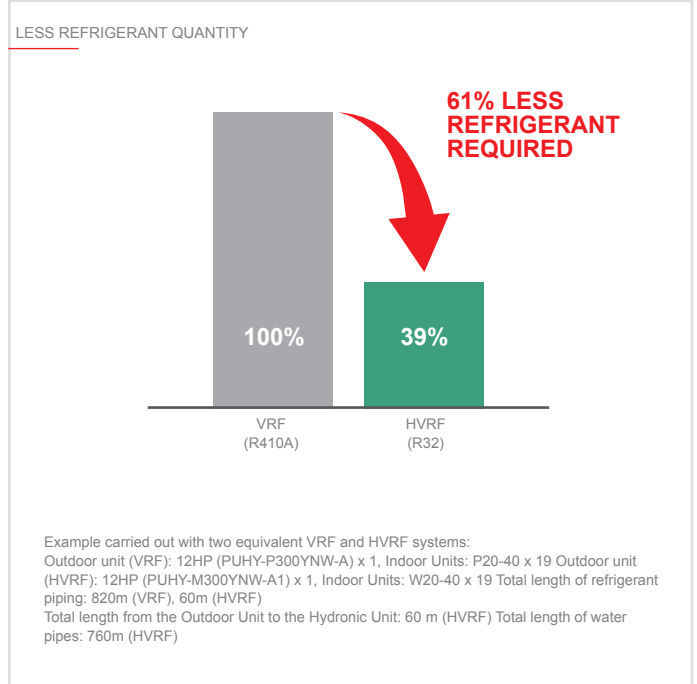
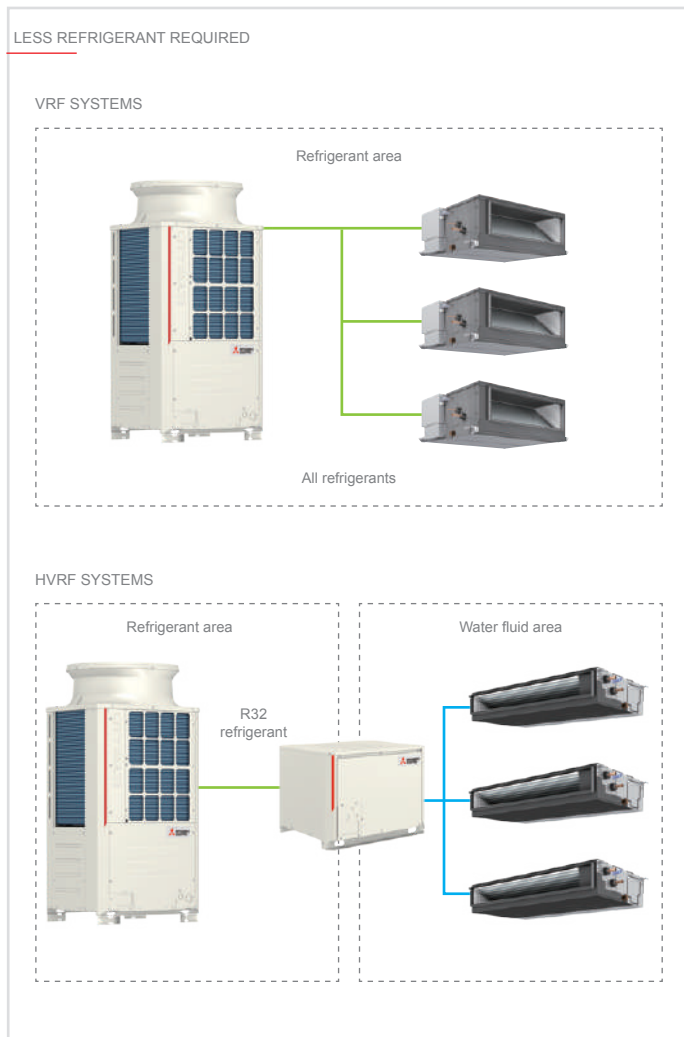

R32 refrigerant with low environmental impact

Starting from the HVRF Y range, Mitsubishi Electric chooses R32 gas with low GWP ("global warming potential") 675, approximately 67% less than the 2088 value of R410A gas.

The advantage is in terms of a net reduction in the amount of CO2 equivalent in the environment. Adding the benefits of 61% less refrigerant and 67% less GWP, the reduction amounts to 87% for the CO2 released in the environment.

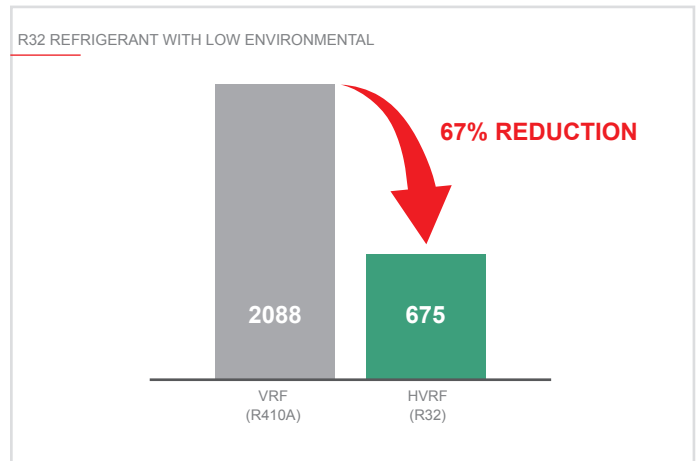



Hydronic unit



HYDRONICVRF

R32

Hydronic unit

The hydronic unit is the fundamental element of the HVRF Y heat pump system, it connects the CITY MULTI outdoor unit to the indoor units via the hydronic system.

The integrated plate exchanger exchanges heat between refrigerant and water.

The integrated pump regulated by an inverter allows the water to reach the indoor units according to the actual cooling and heating needs, allowing efficient operation.

The R32 refrigerant pipes are limited in the section between the Outdoor Unit and the Hydronic Unit, helping to reduce the amount of refrigerant compared to VFR CITY MULTI systems.

The HVRF Y system's hydronic unit can be installed in the building, making the use of antifreeze unnecessary. This reduces energy consumption compared to traditional chillers.

Optimal control

The Hydronic unit automatically calculates the water flow rate required for all indoor units by adapting the flow according to the required load. The pump is controlled with the inverter to determine the amount of water according to the internal load.

The optimal temperature of the supply water is automatically calculated and the corresponding command is communicated to the outdoor unit to define the evaporation and condensation target for the refrigerant gas production.

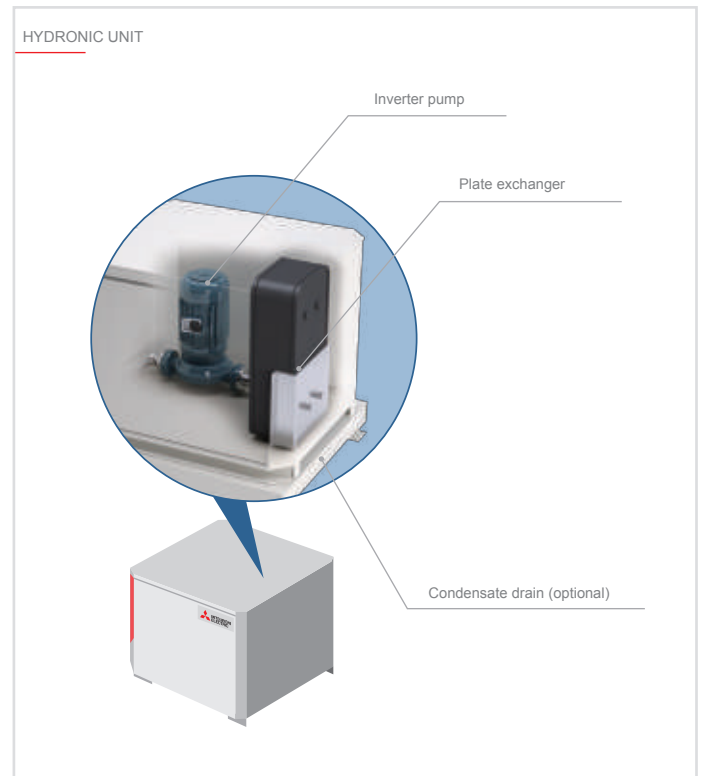



HVRF Y System architecture

Outdoor unit

Development of the compressor for the adoption of R32 refrigerant

R32 gas has a higher discharge temperature than R410A gas.

To better manage the increase in the discharge temperature, Mitsubishi Electric has redesigned the compressor by equipping it with a liquid injection mechanism in the suction chamber.

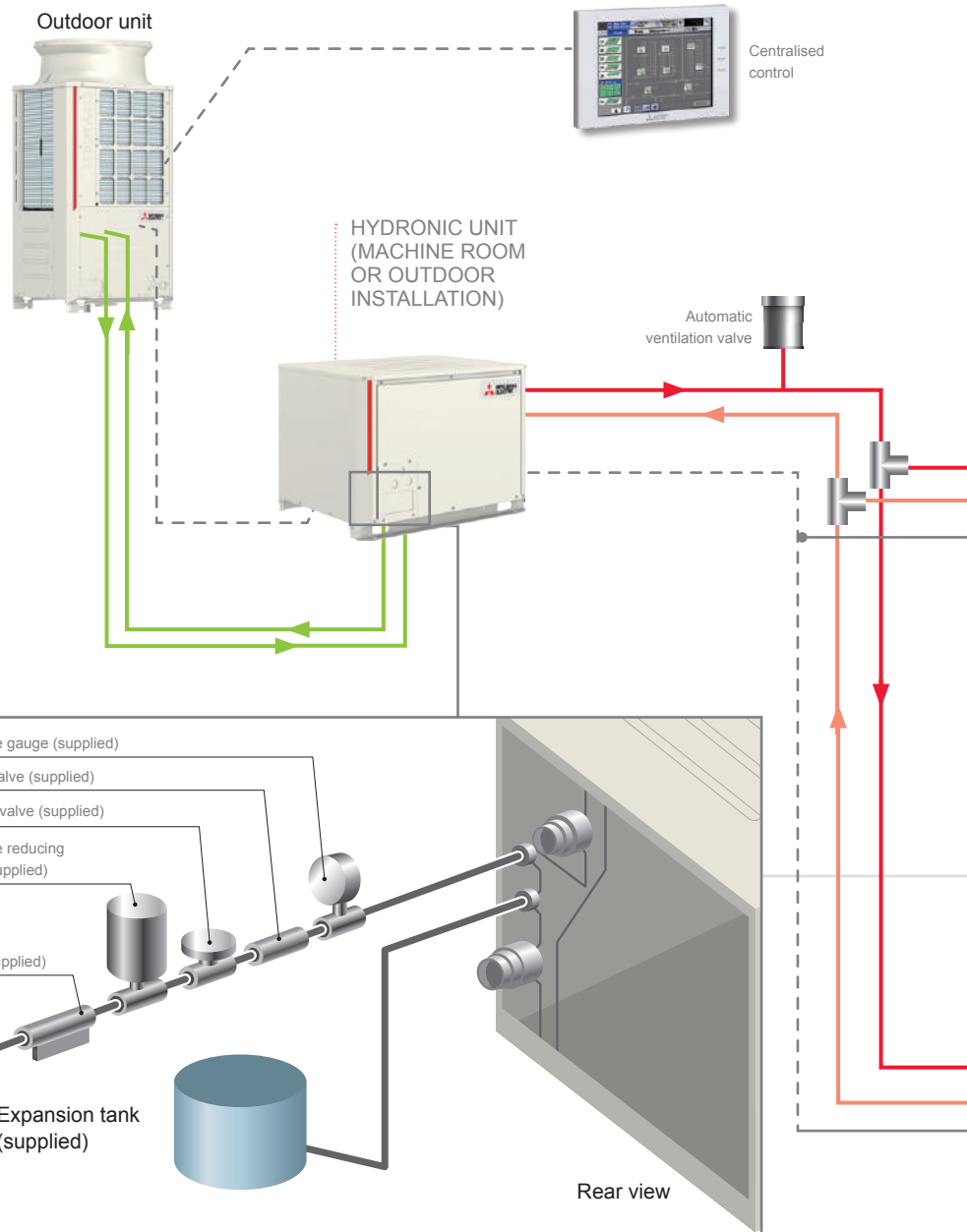
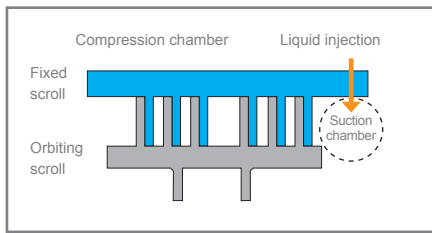

*Depending on the installation conditions, it may be necessary to use safety devices.

- Refrigerant
- Hot water supply
- Hot water return
- - - M-NET



Control systems

System control through M-NET

Mitsubishi Electric outdoor unit, indoor units, hydronic unit and individual and centralised control systems communicate through the M-Net communication system for optimal control of the entire system.

Indoor unit

Optimal control with the flow control valve

HVRF Y system indoor units are fitted with a flow control valve. Based on the internal load of each room, opening the valve automatically allows the correct supply of water to the indoor units serving each room.

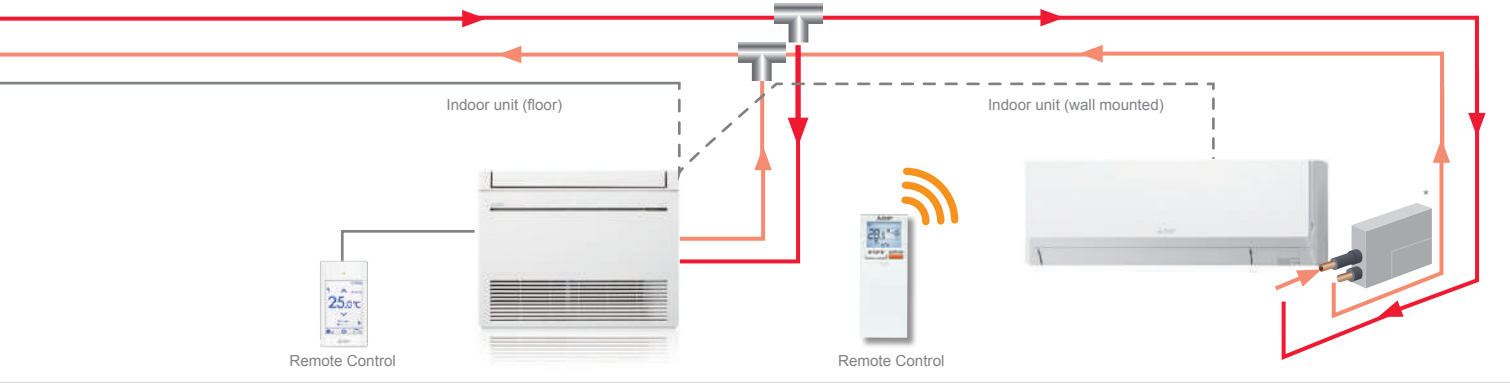
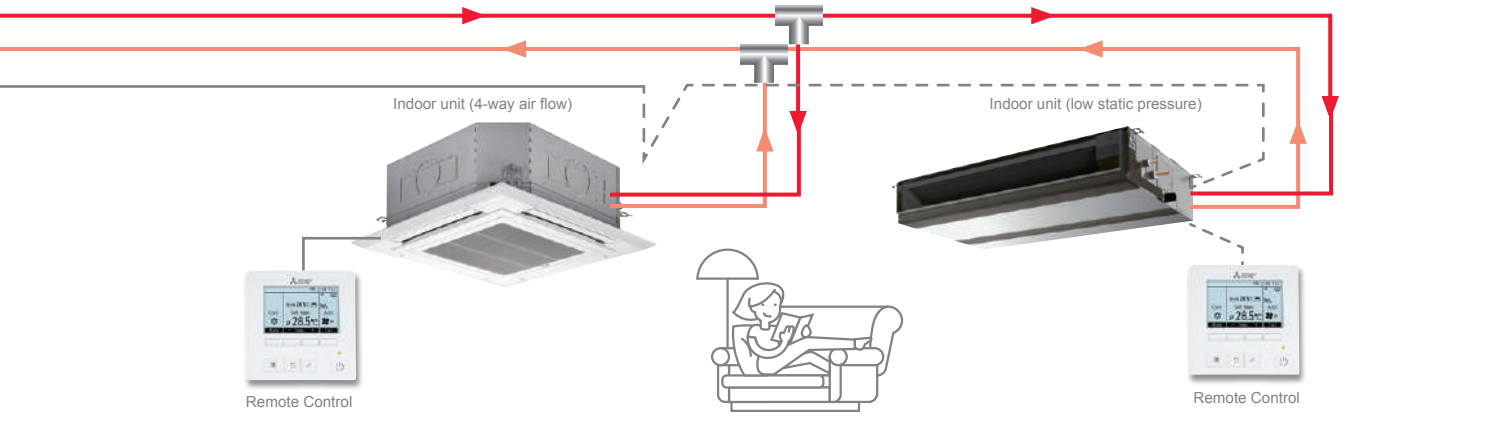
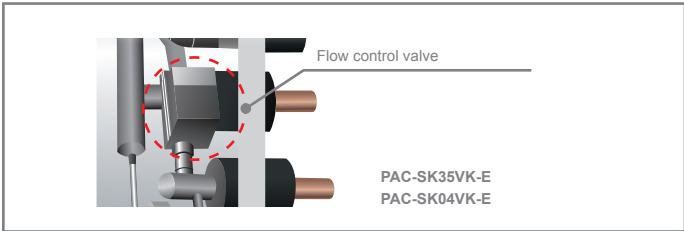

Specifications

Y Line OUTDOOR UNITS - HEAT PUMPS



R32



Technical specifications

MODEL			PUHY-M200YNW-A1(-BS)	PUHY-M250YNW-A1(-BS)	PUHY-M300YNW-A1(-BS)	PUHY-M350YNW-A1(-BS)	
HP			8	10	12	14	
Power Supply	Tens./Freq./Phases	V/Hz/n°	3-phase 4-wire 380-400-415 V 50/60 Hz				
Cooling	Nominal capacity*1	kW	22,4	28,0	33,5	40	
	Power input	kW	5,53	8,38	9,85	12,15	
	EER*	kW	4,05	3,34	3,40	3,29	
	Temperature operating fields	Indoor BU	°C	15,0~24,0	15,0~24,0	15,0~24,0	15,0~24,0
		Outdoor BS	°C	-5,0~52,0	-5,0~52,0	-5,0~52,0	-5,0~52,0
Heating	Nominal capacity*2	kW	25,0	31,5	37,5	45	
	Power input	kW	5,70	8,18	9,66	12,16	
	COP*	kW	4,38	3,85	3,88	3,70	
	Temperature operating fields	Indoor BU	°C	15,0~27,0	15,0~27,0	15,0~27,0	15,0~27,0
		Outdoor BS	°C	-20,0~15,5	-20,0~15,5	-20,0~15,5	-20,0~15,5
Sound pressure*3			58,0 / 59,0 75,0 / 78,0	60,0 / 61,0 78,0 / 80,0	61,0 / 64,5 80,0 / 83,5	62,0 / 64,0 80,5 / 83,0	
	Connectable int. units.	Model/Quantity	W10~125, WL10~50/1~26	W10~125, WL10~50/1~32	W10~125, WL10~50/2~39	W10~125, WL10~50/2~45	
Ø refrigerant pipe	Liquid/Gas	mm	9,52/22,2	9,52/22,2	9,52/22,2	12,7/28,58	
External dimensions **	(HxLxD)	mm	1858 x 920 x 740	1858 x 920 x 740	1858 x 920 x 740	1858 x 1240 x 740	
Net weight			222	222	223	270	
Refr. charge R32/CO ₂ Eq			6,5/4,39	6,5/4,39	6,5/4,39	9,8/6,62	

*1 Rated cooling conditions: Indoor 27°C BS / 19°C BU. Outdoor 35°C BS. Pipe length 7.5 m, level difference 0 m.

*2 Rated heating conditions: Indoor 20°C BS. External 7°C BS / 6°C BU. Pipe length 7.5 m, level difference 0 m.

*3 Values measured in anechoic chamber. Cooling / Heating

*4 GWP of HFC R32 equal to 675 according to regulation 517 / 2014

* The COP and EER coefficients are system performances and as such do not refer just to the outdoor unit but include both the water production coefficients (Outdoor Unit + Hydronic Unit) and the water distribution coefficients (Hydronic Unit + Indoor units).

** Without removable support feet, A = 1798 mm



Technical specifications

MODEL			PUHY-M400YNW-A1(-BS)	PUHY-M450YNW-A1(-BS)	PUHY-M500YNW-A1(-BS)
HP			16	18	20
Power Supply	Tens./Freq./Phases	V/Hz/n°	3-phase 4-wire 380-400-415 V 50/60 Hz		
Cooling	Nominal capacity*1	kW	45	50	56
	Power input	kW	14,65	14,70	17,72
	EER*	kW	3,07	3,40	3,16
	Temperature operating fields	Indoor BU	°C	15,0~24,0	15,0~24,0
Outdoor BS		°C	-5,0~52,0	-5,0~52,0	-5,0~52,0
Heating	Nominal capacity*2	kW	50	56	63
	Power input	kW	13,69	16	17,07
	COP*	kW	3,65	3,50	3,69
	Temperature operating fields	Indoor BU	°C	15,0~27,0	15,0~27,0
Outdoor BS		°C	-20,0~15,5	-20,0~15,5	-20,0~15,5
Sound pressure*3		dB(A)	65.0 / 67.0 82.5 / 86.0	65.5 / 69.5 83.5 / 88.5	63.5 / 66.5 82 / 85.5
Connectable int. units.	Model/Quantity		W10~125,WL10~50/2~50	W10~125, WL10~50/2~50	W10~125, WL10~50/2~50
Ø refrigerant pipe	Liquid/Gas	mm	12,7/28,58	15,88/28,58	15,88/28,58
External dimensions **	(HxLxD)	mm	1858 x 1240 x 740	1858 x 1240 x 740	1858 x 1750 x 740
Net weight		kg	273	290	329
Refr. charge R32/CO ₂ Eq		kg/Tons	9,8/6,62	10,8/7,29	10,8/7,29

*1 Rated cooling conditions: Indoor 27°C BS / 19°C BU. Outdoor 35°C BS. Pipe length 7.5 m, level difference 0 m.

*2 Rated heating conditions: Indoor 20°C BS. External 7°C BS / 6°C BU. Pipe length 7.5 m, level difference 0 m.

*3 Values measured in anechoic chamber. Cooling / Heating

*4 GWP of HFC R32 equal to 675 according to regulation 517 / 2014

* The COP and EER coefficients are system performances and as such do not refer just to the outdoor unit but include both the water production coefficients (Outdoor Unit + Hydronic Unit) and the water distribution coefficients (Hydronic Unit + Indoor units).

** Without removable support feet, A = 1798 mm

Hydronic unit



R32

Technical specifications

MODEL			CMH-WM250V-A		CMH-WM350V-A		CMH-WM500V-A	
Power source	Phases/ Tens.		1-phase 220-230-240 V					
	Frequency		50 Hz					
Power input	Cooling	kW	0.74		0.90		1.06	
	Heating	kW	0.74		0.90		1.06	
Sound pressure level (measured in anechoic room)		dB <A>	60		60		60	
Applicable temperature range of installation site		°C (D.B.)	-5~52		-5~52		-5~52	
Connectable outdoor/heat source unit capacity			M200~250		M300~350		M400~500	
External dimension	HxWxD	mm	660 x 920 x 740		660 x 920 x 740		660 x 920 x 740	
Refrigerant piping diameter	To outdoor/heat source unit		Connectable outdoor/heat source unit capacity		Connectable outdoor/heat source unit capacity		Connectable outdoor/heat source unit capacity	
			M200	M250	M300	M350	M400	M450/500
	Liquid pipe	mm O.D.	9.52	9.52	9.52	12.7	12.7	15.88
	Gas pipe	mm O.D.	22.2	22.2	22.2	28.58	28.58	28.58
Water piping diameter	To Indoor unit							
	Inlet Pipe	mm I.D.	40 (1-1/2) housing joint		40 (1-1/2) housing joint		50 (2) housing joint	
	Outlet Pipe	mm I.D.	40 (1-1/2) housing joint		40 (1-1/2) housing joint		50 (2) housing joint	
Net weight		kg	112		117		143	

*The equipment is for R32 refrigerant.

*Install this product in a location where noise (refrigerant noise) emitted by the unit will not disturb the neighbors.

(For use in quiet environments with low background noise, position the Hydro unit at least 5 m away from any indoor units.)

*Please install the Hydro unit in a place where noise will not be an issue.

*Please attach an expansion vessel (field supply).

*Use copper, plastic, steel, or stainless steel pipes for the water circuit.

Furthermore, when using copper pipe-work use a non-oxidative brazing method.

Oxidation of the pipe-work will reduce the pump life.

*When brazing the pipes, be sure to blaze, after covering a wet cloth to the insulation pipes of the units in order to prevent it from burning and shrinking by heat.

*Please install an air purge valve where air will gather in the water circuit.

*Please install a pressure reducing valve and a strainer on the water supply to the Hydro unit.

*Please refer to the databook or the installation manual for the specified water quality.

*Please always make water circulate or pull out the circulation water completely when not using it.

(Please do not use it as a drinking water.)

*Please do not use ground water and well water.

*When installing the Hydro unit in an environment which may drop below 0 °C, please add antifreeze to the circulating water.(Refer to the data-book and the installation manual).

*R32 is flammable, and certain restrictions apply to the installation of units.

When installing new units, moving the existing units, or changing the layout of the room, ensure that installation restrictions are observed.

For detail, refer to the section in the Databook on installation restrictions.

*Drain or condensation water will be discharged from hydro units during test run.

If this will be a problem, install a separately sold drain pan.

*Do not install the unit where it could be salt-damaged.



Design guide

HVRF Hydronic Heat Pump Systems

Item	Circuit section	Maximum length (m)
Effective length between outdoor unit and hydronic unit		
(Refrigerant piping)	A	110
Effective length between Outdoor Unit and furthest indoor unit (L1)	$A+A'+C+D+E+g/A+B+c$	165
Effective length between Hydronic Unit and furthest indoor unit (L2)	$A'+C+D+E+g/A'+B+c$	60
Difference in height between outdoor unit and indoor unit		
(Outdoor unit above/below the indoor unit)	H/H'	90/60
Difference in height between outdoor unit and hydronic unit		
(Outdoor unit above/below the hydronic unit)	H1/H1'	50' / 40 ²
Difference in height between hydronic unit and indoor unit		
(Hydronic unit above/below the indoor unit)	H2/ H2'	50/40
Difference in height between indoor units	h1	30

*1 90 m is available depending on the model and installation conditions. For more detailed information, please contact your local distributor.
 *2 60 m is available depending on the model and installation conditions. For more detailed information, please contact your local distributor.

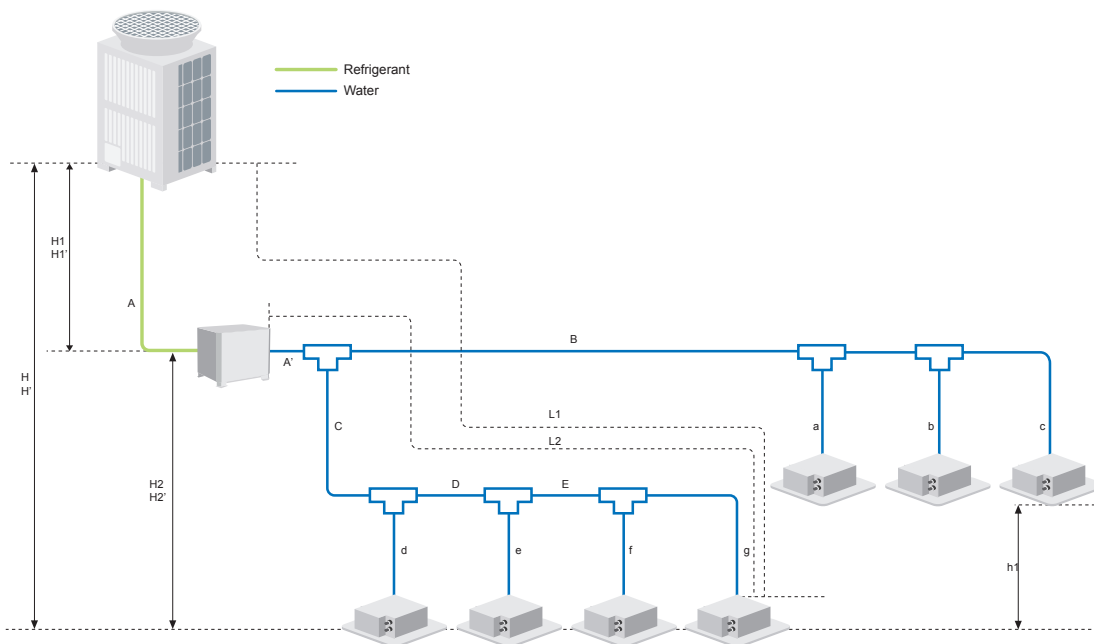

HVRF Systems Line

Heat recovery systems

HVRF R2/WR2 systems

HEAT RECOVERY

182

Hydronic Branch Controller (HBC)

184

HVRF R2/WR2 System architecture

186

System Components

AIR-COOLED

PURY-P YNW-A1 (-BS)

188

WATER-COOLED

PQRY-P YLM-A1

190

MAIN HBC CONTROLLER

CMB-WMV

192

Design guide

194



HYDRONICVRF



HVRF R2/WR2 systems

Heat Recovery



Hydronic CITY MULTI

Hydronic CITY MULTI is the first and only system in the world derived from the R2 system to guarantee a high degree of air comfort with the advantages of direct expansion with variable refrigerant flow.

Why Hydronic VRF

Hydronic CITY MULTI is a heat recovery system (simultaneous heating and cooling) which becomes part of the CITY MULTI family and which adopts water for the first time to distribute the heating and cooling power in the room.

Hydronic BC Distributor

Simultaneous cooling/heating with heat recovery. The new Hydronic CITY MULTI is the first and only two-pipe system in the world for simultaneous cooling and heating with heat recovery that combines the advantages of the direct expansion system with those of the traditional hydronic system. The technology is based on Mitsubishi Electric's CITY MULTI R2 heat recovery system and consists of an R2 (or WR2) outdoor unit of the CITY MULTI series, the innovative Hydronic BC (HBC) distributor which allows the use of refrigerant gas and water as heat carrier fluids, as well as indoor units specially equipped with a water coil.

Lower concentration of R410 GAS

The use of hydronic distribution allows the limits linked to the stringent legislation (UNI EN 378) on the concentration of refrigerant gases to be overcome: this is possible thanks to the fact that the only portion of the system that contains refrigerant gas is the one that connects the outdoor unit to the Hydronic BC Controller distributor. In this way it is possible to obtain up to 45% reduction of the refrigerant charge compared to a traditional VRF system.

2-Pipe systems

Compared to a traditional 4-pipe hydronic system, the design and installation of the 2-pipe system is very flexible and simplified. For example, the Hydronic CITY MULTI system does not need additional pumps, tanks or switching valves. The significantly smaller number of connection points in the two-pipe system limits its potential for leakage, makes it safer and reduces the need for maintenance.

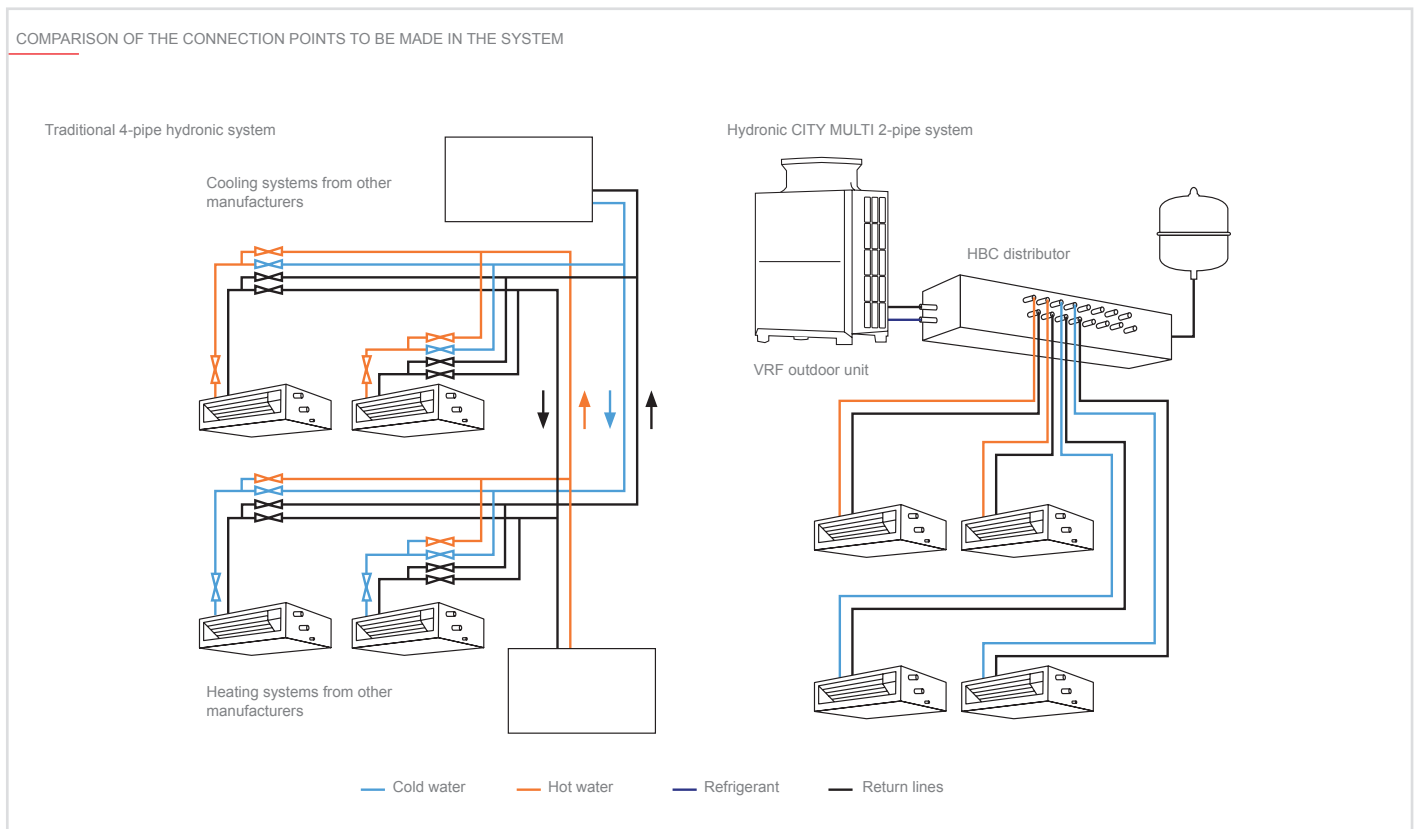



Hydronic Branch Controller (HBC)

The heart of Hybrid VRF

Plate heat exchangers

This is the component where the refrigerant gas is able to yield/absorb heat from the water line.

Two plate heat exchangers are installed, located at the ends of the HBC. Both can produce hot water during heating mode and cold water during cooling mode.

During “simultaneous mode” one of the heat exchangers produces hot water while the other one cold water.

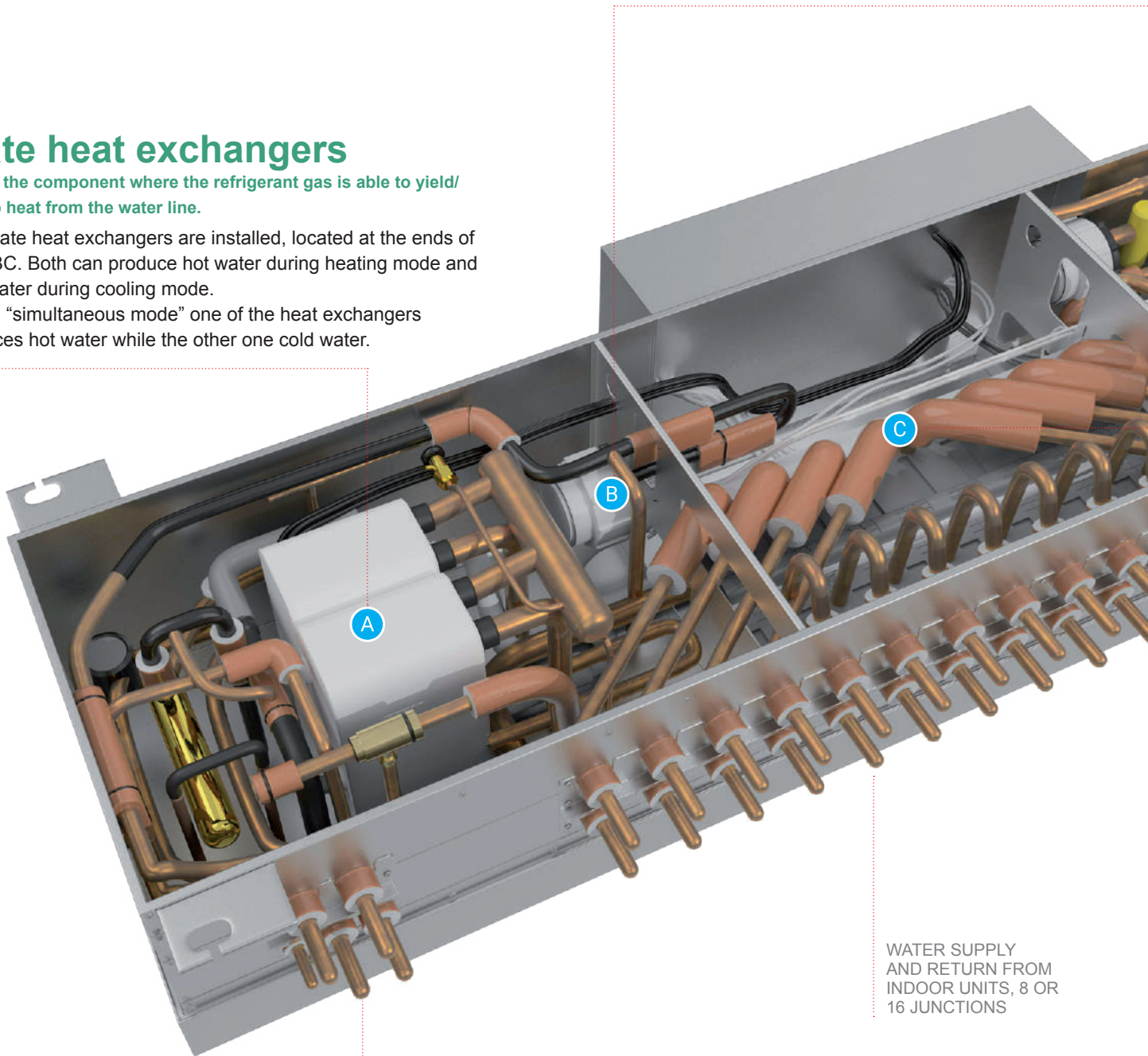

REFRIGERANT PIPES TO OUTDOOR UNIT, EXPANTION VESSEL (FIELD SUPPLIED) AND WATER FEEDING LINE (FIELD SUPPLIED)

WATER SUPPLY AND RETURN FROM INDOOR UNITS, 8 OR 16 JUNCTIONS

Pumps

Both plate heat exchangers are equipped with inverter DC pumps.

The pumps allow circulation of water between HBC and the indoor units. The flow rate is controlled by a valves block.

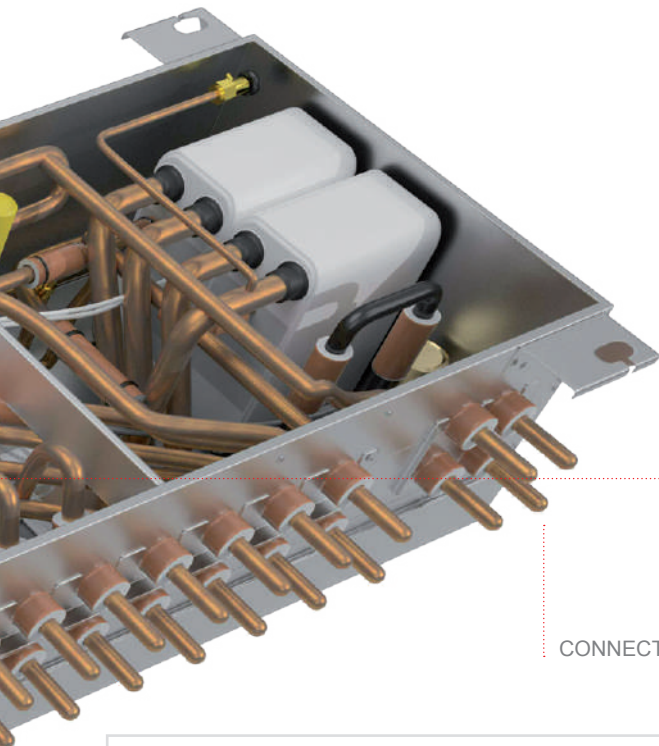

Valves Block

A set of valves is connected to supply and return pipes of each indoor unit.

This valves block has two tasks: firstly it selects the hot or cold water header and then it regulates the flow fed to the indoor units based on the thermal power required.

CONNECTION TO SUB HBC

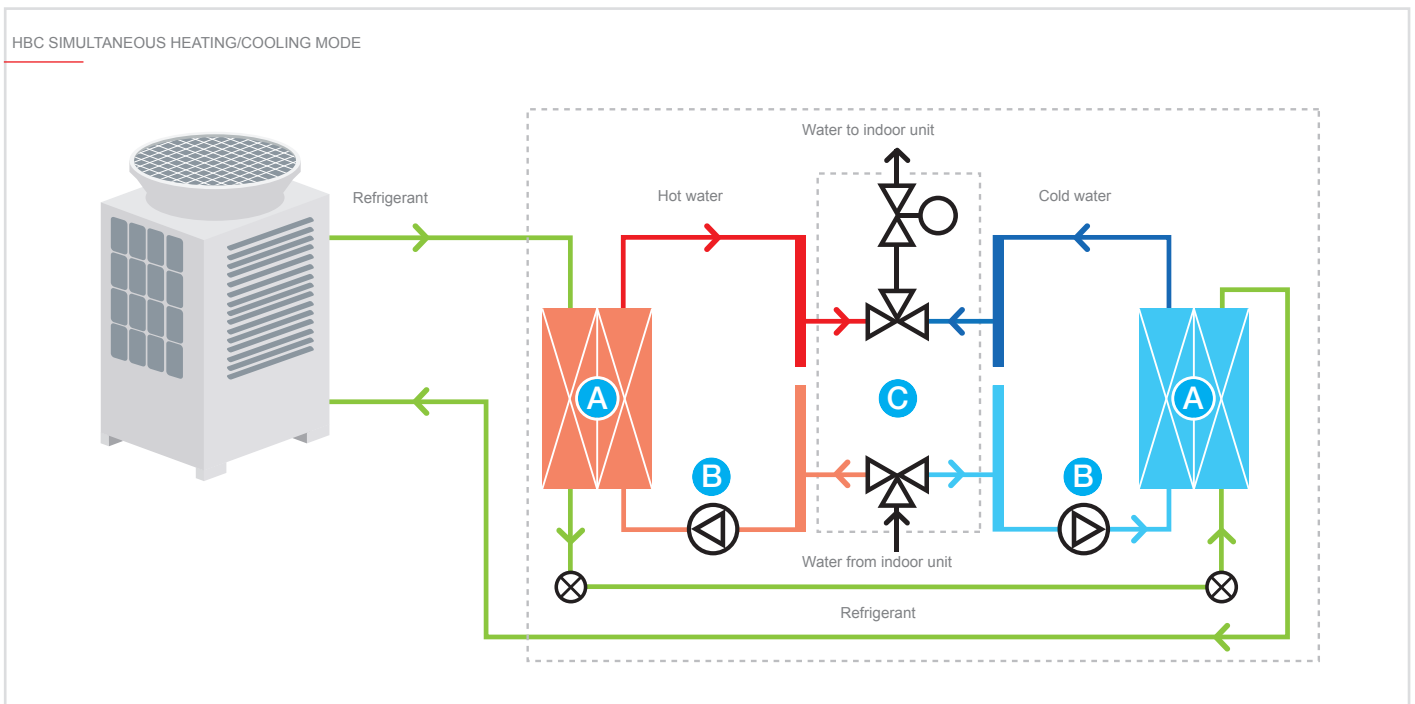



HVRF R2/WR2 System architecture

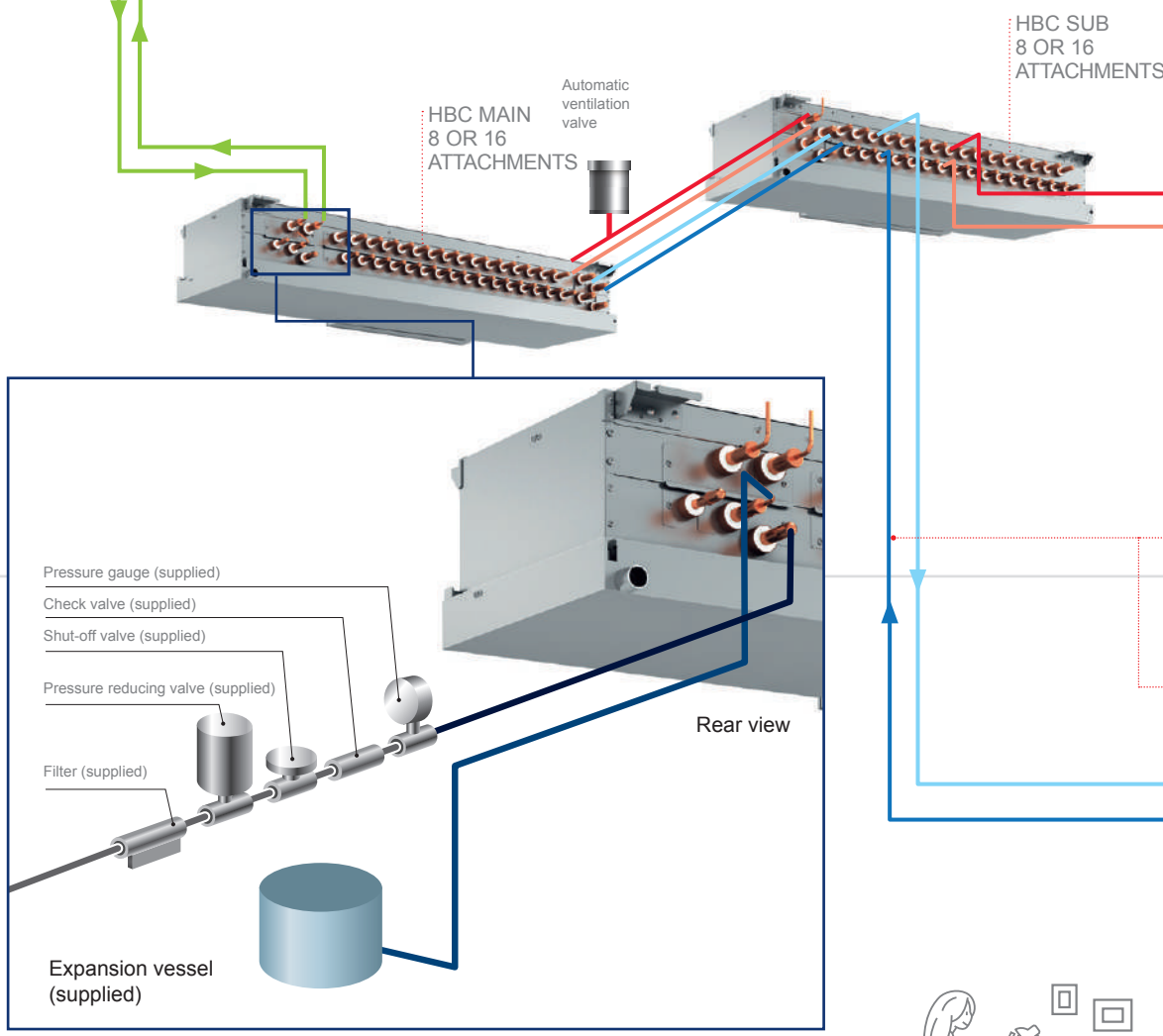

- Refrigerant
- Hot water supply
- Hot water return
- Cold water supply
- Cold water return



PURY/PQRY Outdoor unit	FIRST HBC MAIN	FIRST HBC SUB	SECOND HBC MAIN	SECOND HBC SUB
P200	•	•*	X	X
P250	•	•*	X	X
P300	•	•*	•*	•*
P350	•	•*	•*	•*
P400	•	•*	•	•*
P450	•	•*	•	•*
P500	•	•*	•	•*

*Optional

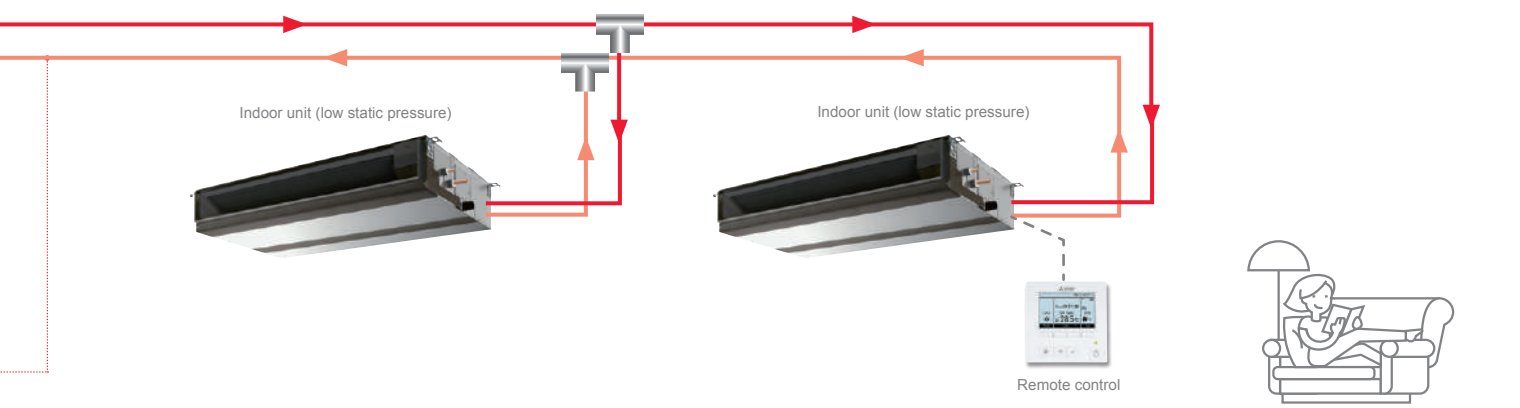

The water pipes (20 mm) provide heating and cooling simultaneously

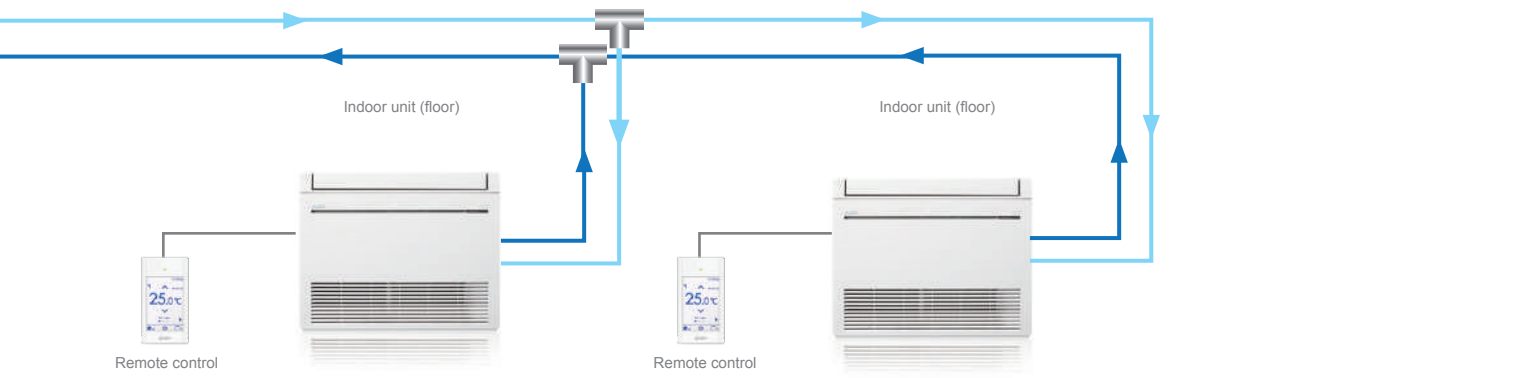

Specifications

R2 Line HEAT RECOVERY OUTDOOR UNIT



Technical specifications

MODEL			PURY-P200YNW-A1 (-BS)	PURY-P250YNW-A1(-BS)	PURY-P300YNW-A1 (-BS)	PURY-P300YNW-A1 (-BS) X2 HBC	
HP			8	10	12	12	
Power Supply	Tens./Freq./Phases	V/Hz/n°	3 fasi 380-400-415V 50Hz				
Cooling	Nominal capacity* ¹	kW	22,4	28,0	33,5	33,5	
	Power input	kW	6,54	9,92	13,13	11,12	
	EER*	kW	3,42	2,82	2,55	3,01	
	Temperature operating fields	Indoor BU	°C	15,0~24,0	15,0~24,0	15,0~24,0	15,0~24,0
		Outdoor BS	°C	-5,0~52,0	-5,0~52,0	-5,0~52,0	-5,0~52,0
Heating	Nominal capacity* ²	kW	25,0	31,5	37,5	37,5	
	Power input	kW	6,49	10,06	12,71	11,94	
	COP*	kW	3,85	3,13	2,95	3,14	
	Temperature operating fields	Indoor BU	°C	15,0~27,0	15,0~27,0	15,0~27,0	15,0~27,0
		Outdoor BS	°C	-20,0~15,5	-20,0~15,5	-20,0~15,5	-20,0~15,5
Sound pressure* ³		dB(A)	59,0/59,0 (76/78)	60,5/61,0 (78/80)	61,0/67,0 (80/86)	61,0/67,0(80/86)	
Connectable int. units.	Model/Quantity		1~30	1~37	2~45	2~45	
Ø refrigerant pipe	Liquid/Gas	mm	15,88/19,05	19,05/22,2	19,05/22,2	19,05/22,2	
External dimensions **	(HxLxD)	mm	1858 x 920 x 740	1858 x 920 x 740	1858 x 920 x 740	1858 x 920 x 740	
Net weight		kg	214	223	225	225	
Refr. charge R410A/CO ₂ Eq		kg/Tons	5,2/10,86	5,2/10,86	5,2/10,86	5,2/10,86	

*¹ Rated cooling conditions: Indoor 27°C BS / 19°C BU. Outdoor 35°C BS. Pipe length 7.5 m, level difference 0 m.

*² Rated heating conditions: Indoor 20°C BS. External 7°C BS / 6°C BU. Pipe length 7.5 m, level difference 0 m.

*³ Values measured in anechoic chamber. Cooling / Heating

*⁴ GWP of HFC R410A equal to 2088 according to regulation 517 / 2014

* The COP and EER coefficients are system performances and as such do not refer just to the outdoor unit but include both the water production coefficients (Outdoor Unit + Hydronic Unit) and the water distribution coefficients (Hydronic Unit + Indoor units).

** Without removable support feet, A = 1798 mm

Technical specifications

MODEL			PURY-P350YNW-A1 (-BS)	PURY-P350YNW-A1 (-BS) X2 HBC	PURY-P400YNW-A1 (-BS)	PURY-P450YNW-A1 (-BS)	PURY-P500YNW-A1 (-BS)	
HP			14	14	16	18	20	
Power Supply	Tens./Freq./Phases	V/Hz/n°	3 fasi 380-400-415V 50Hz					
Cooling	Nominal capacity*1	kW	40,0	40,0	45	50,0	56,0	
	Power input	kW	16,26	13,24	16,65	17,92	24,03	
	EER*	kW	2,46	3,02	2,70	2,79	2,33	
	Temperature operating fields	Indoor BU	°C	15,0~24,0	15,0~24,0	15,0~24,0	15,0~24,0	15,0~24,0
		Outdoor BS	°C	-5,0~52,0	-5,0~52,0	-5,0~52,0	-5,0~52,0	-5,0~52,0
Heating	Nominal capacity*2	kW	45,0	45,0	50	56,0	63,0	
	Power input	kW	13,88	12,85	14,88	17,39	19,09	
	COP*	kW	3,24	3,50	3,36	3,22	3,30	
	Temperature operating fields	Indoor BU	°C	15,0~27,0	15,0~27,0	15,0~27,0	15,0~27,0	15,0~27,0
		Outdoor BS	°C	-20,0~15,5	-20,0~15,5	-20,0~15,5	-20,0~15,5	-20,0~15,5
Sound pressure*3		dB(A)	62,5/64,0(81/83)	62,5/64,0(81/83)	65,0/69,0 (83/88)	65,5/70,0 (83/89)	63,5/64,5(82/84)	
Connectable int. units.	Model/Quantity		2~50	2~50	2~50	2~50	2~50	
Ø refrigerant pipe	Liquid/Gas	mm	19,05/28,58	19,05/28,58	22,2/28,58	22,2/28,58	22,2/28,58	
External dimensions **	(HxLxD)	mm	1858 x 1240 x 740	1858 x 1240 x 740	1858 x 1240 x 740	1858 x 1240 x 740	1858 x 1750 x 740	
Net weight		kg	269	269	269	289	335	
Refr. charge R410A/CO ₂ Eq		kg/Tons	8/16,70	8/16,70	8/16,70	10,8/22,55	10,8/22,55	

*1 Rated cooling conditions: Indoor 27°C BS / 19°C BU. Outdoor 35°C BS. Pipe length 7.5 m, level difference 0 m.

*2 Rated heating conditions: Indoor 20°C BS. External 7°C BS / 6°C BU. Pipe length 7.5 m, level difference 0 m.

*3 Values measured in anechoic chamber. Cooling / Heating

*4 GWP of HFC R410A equal to 2088 according to regulation 517 / 2014

* The COP and EER coefficients are system performances and as such do not refer just to the outdoor unit but include both the water production coefficients (Outdoor Unit + Hydronic Unit) and the water distribution coefficients (Hydronic Unit + Indoor units).

** Without removable support feet, A = 1798 mm

WR2 Line

WATER CONDENSED HEAT RECOVERY OUTDOOR UNIT



Technical specifications

MODEL			PQRY-P200YLM-A1	PQRY-P250YLM-A1	PQRY-P300YLM-A1	PQRY-P300YLM-A1 X2 HBC
HP			8	10	12	12
Power Supply	Tens/Freq./Phases	V/Hz/n°	3 phase 380-400-415V 50Hz			
Cooling	Nominal capacity ¹	kW	22,4	28,0	33,5	33,5
	Power input	kW	3,97	5,44	7,55	6,71
	EER*	kW	5,64	5,14	4,43	4,99
	Temperature operating fields	Indoor BU	°C	15,0~24,0	15,0~24,0	15,0~24,0
Outdoor BS		°C	10,0~45,0	10,0~45,0	10,0~45,0	10,0~45,0
Heating	Nominal capacity ²	kW	25,0	31,5	37,5	37,5
	Power input	kW	4,04	5,41	7,13	6,79
	COP*	kW	6,18	5,82	5,25	5,52
	Temperature operating fields	Indoor BS	°C	15,0~27,0	15,0~27,0	15,0~27,0
Outdoor BU		°C	10,0~45,0	10,0~45,0	10,0~45,0	10,0~45,0
Sound pressure ³		dB(A)	46 (60)	48 (62)	54(68)	54(68)
Connectable int. units.			50~150% of outdoor unit capacity	50~150% of outdoor unit capacity	50~150% of outdoor unit capacity	50~150% of outdoor unit capacity
	Connectable int. units		1~30	1~37	3~45	2~45
Ø refrigerant pipe	Liquid/Gas	mm	15,88/19,05	19,05/22,2	19,05/22,2	19,05/22,2
Water circuit	Norm flow rate	m ³ /h	5,76	5,76	5,76	5,76
	Water flow rate range	m ³ /h	3,0-7,2	3,0-7,2	3,0-7,2	3,0-7,2
	Pressure drop	kPa	24	24	24	24
	Heat exch. volume	l	5	5	5	5
External dimensions (HxLxD)			1100 x 880 x 550	1100 x 880 x 550	1100 x 880 x 550	1100 x 880 x 550
Net weight			173	173	172	173
Refr. charge R410A ⁴ /CO ₂ Eq			5/10,44	5/10,44	5/10,44	5/10,44

¹ Rated cooling conditions: Indoor 27°C BS / 19°C BU. Outdoor 35°C BS. Pipe length 7.5 m, level difference 0 m.

² Rated heating conditions: Indoor 20°C BS. External 7°C BS / 6°C BU. Pipe length 7.5 m, level difference 0 m.

³ Values measured in anechoic chamber. Cooling / Heating

⁴ GWP of HFC R410A equal to 2088 according to regulation 517 / 2014

* The COP and EER coefficients are system performances and as such do not refer just to the outdoor unit but include both the water production coefficients (Outdoor Unit + Hydronic Unit) and the water distribution coefficients (Hydronic Unit + Indoor units).

** Without removable support feet, A = 1798 mm

Technical specifications

MODEL			PQRY-P350YLM-A1	PQRY-P350YLM-A1 X2 HBC	PQRY-P400YLM-A1	PQRY-P450YLM-A1	PQRY-P500YLM-A1
HP			14	14	16	18	20
Power Supply	Tens/Freq./Phases	V/Hz/n°	3 fasi 380-400-415V 50Hz				
Cooling	Nominal capacity ¹	kW	40,0	40,0	45,0	50,0	56,0
	Power input	kW	9,98	8,72	10,05	12,05	14,58
	EER*	kW	4,00	4,58	4,47	4,14	3,84
	Temperature operating fields	Indoor BU	°C	15,0~24,0	15,0~24,0	15,0~24,0	15,0~24,0
Outdoor BS		°C	10,0~45,0	10,0~45,0	10,0~45,0	10,0~45,0	10,0~45,0
Heating	Nominal capacity ²	kW	45,0	45,0	50,0	56,0	63,0
	Power input	kW	8,87	8,25	9,45	11,11	13,07
	COP*	kW	5,07	5,45	5,29	5,04	4,82
	Temperature operating fields	Indoor BS	°C	15,0~27,0	15,0~27,0	15,0~27,0	15,0~27,0
Outdoor BU		°C	10,0~45,0	10,0~45,0	10,0~45,0	10,0~45,0	10,0~45,0
Sound pressure ³		dB(A)	52(66)	52(66)	52(66)	54(70)	54(70,5)
Connectable int. units.			50~150% of outdoor unit capacity	50~150% of outdoor unit capacity	50~150% of outdoor unit capacity	50~150% of outdoor unit capacity	50~150% of outdoor unit capacity
	Connectable int. units		2~50	2~50	2~50	2~50	5~50
Ø refrigerant pipe	Liquid/Gas	mm	22,2/28,58	22,2/28,58	22,2/28,58	22,2/28,58	22,2/28,58
Water circuit	Norm flow rate	m³/h	7,20	7,20	7,20	7,20	7,20
	Water flow rate range	m³/h	4,5-11,6	4,5-11,6	4,5-11,6	4,5-11,6	4,5-11,6
	Pressure drop	kPa	44	44	44	44	44
	Heat exch. volume	l	5	5	5	5	5
External dimensions (HxLxD)			mm	1450 x 880 x 550	1450 x 880 x 550	1450 x 880 x 550	1450 x 880 x 550
Net weight			kg	217	217	217	217
Refr. charge R410A ⁴ /CO ₂ Eq			kg/Tons	6/12,53	6/12,53	6/12,53	6/12,53

¹ Rated cooling conditions: Indoor 27°C BS / 19°C BU. Outdoor 35°C BS. Pipe length 7.5 m, level difference 0 m.

² Rated heating conditions: Indoor 20°C BS. External 7°C BS / 6°C BU. Pipe length 7.5 m, level difference 0 m.

³ Values measured in anechoic chamber. Cooling / Heating

⁴ GWP of HFC R410A equal to 2088 according to regulation 517 / 2014

* The COP and EER coefficients are system performances and as such do not refer just to the outdoor unit but include both the water production coefficients (Outdoor Unit + Hydronic Unit) and the water distribution coefficients (Hydronic Unit + Indoor units).

** Without removable support feet, A = 1798 mm

Main HBC Controller

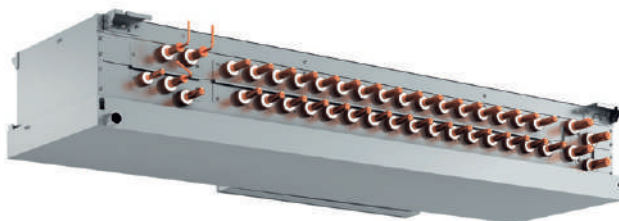

R410A

Technical specifications

MODEL		CMB-WM108V-AA	CMB-WM1016V-AA
Number of branches		8 (22mm OD pipe)	16 (22mm OD pipe)
Net weight	kg	86	98
Weight with water	kg	96	111
Dimensions	Width	1520	1800
	Depth	630	630
	Height	300	300
Power supply		220-240V, 50Hz	220-240V, 50Hz
Phase		1	1
Power input	kW	0.46	0.46
Current	A	2.83	2.83

CMB-WM-V-AA e CMB-WM-V-AB units are to be used exclusively with outdoor units PURY-P200-500YNW-A(1), PQRY-P200-500YLM-A1 and HVRF indoor units (W/WL/WP).
 One HBC Main can be used with PURY-P200-350YNW-A(1), PQRY-P200-350YLM-A1.
 Two HBC Main can be used with PURY-P300-350YNW-A(1), PQRY-P300-350YLM-A1.
 Two HBC Main must be used with PURY-P400-500YNW-A(1), PQRY-P400-500YLM-A1.

Sub HBC Controller

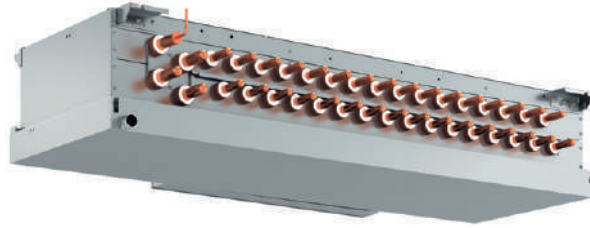

R410A

Technical specifications

MODEL			CMB-WM108V-AB	CMB-WM1016V-AB
Number of branches			8 (22mm OD pipe)	16 (22mm OD pipe)
Net weight		kg	44	53
Weight with water		kg	49	62
Dimensions	Width	mm	1520	1520
	Depth	mm	630	630
	Height	mm	300	300
Power supply			220-240V 50Hz	220-240V, 50Hz
Phase			1	1
Power input		kW	0.01	0.01
Current		A	0.05	0.05

CMB-WM-V-AA e CMB-WM-V-AB units are to be used exclusively with outdoor units PURY-P200-500YNW-A(1), PQRV-P200-500YLM-A1 and HVRF indoor units (WWL/WP)
 One HBC Main can be used with PURY-P200-350YNW-A(1), PQRV-P200-350YLM-A1.
 Two HBC Main can be used with PURY-P300-350YNW-A(1), PQRV-P300-350YLM-A1.
 Two HBC Main must be used with PURY-P400-500YNW-A(1), PQRV-P400-500YLM-A1.



Design guide

HVRF Hydronic Heat Recovery systems

1 HBC Main

Item	Circuit section	Maximum length (m)
Effective length between outdoor unit and HBC Main distributor	A	110
Effective length between HBC distributor and indoor unit	b	60
Height difference between OU and HBC Main (OU above HBC Main)	H	50
Height difference between OU and HBC Main (OU below HBC Main)	H'	40
Difference in height between Indoor unit and HBC distributor	h1	15
Difference in height between indoor units	h2	15

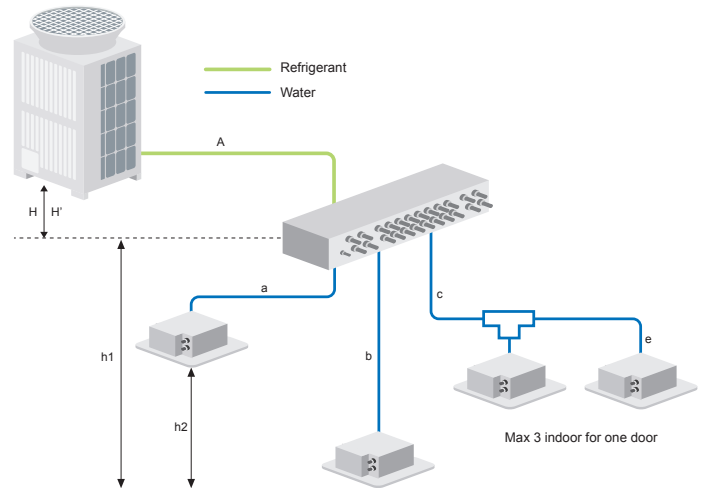

1 HBC Main e 1 HBC Sub

Item	Circuit section	Maximum length (m)
Effective length between outdoor unit and HBC Main distributor	A	110
Effective length between HBC distributor and indoor unit	f+g	60
Height difference between OU and HBC Main (OU above HBC Main)	H	50
Height difference between OU and HBC Main (OU below HBC Main)	H'	40
Difference in height between indoor unit and HBC distributor	h1	15
Difference in height between indoor units	h2	15

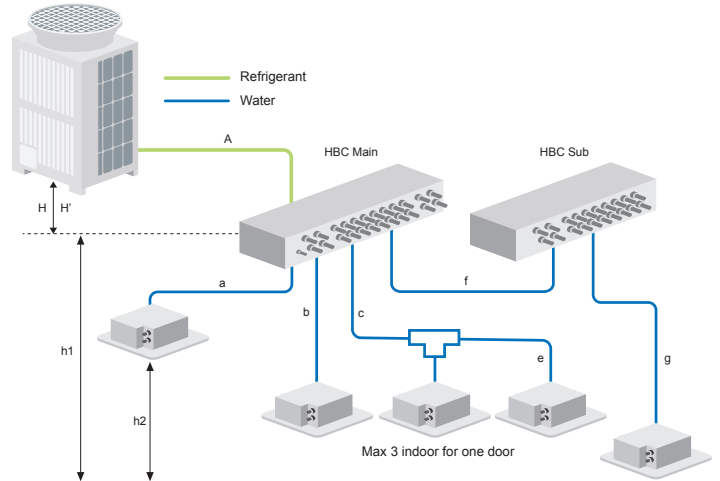

2 HBC Main e 1 HBC Sub

Item	Circuit section	Maximum length (m)
Effective length between outdoor unit and HBC Main distributor	A+B	110
Effective length between HBC distributor and indoor unit	b e (g + h)	60
Height difference between OU and HBC Main (OU above HBC Main)	H	50
Height difference between OU and HBC Main (OU below HBC Main)	H'	40
Difference in height between indoor unit and HBC distributor	h1	15
Difference in height between indoor units	h2	15
Difference in height between HBC Main and HBC Main	h3	15
Length between HBC Main and HBC Main	C	40

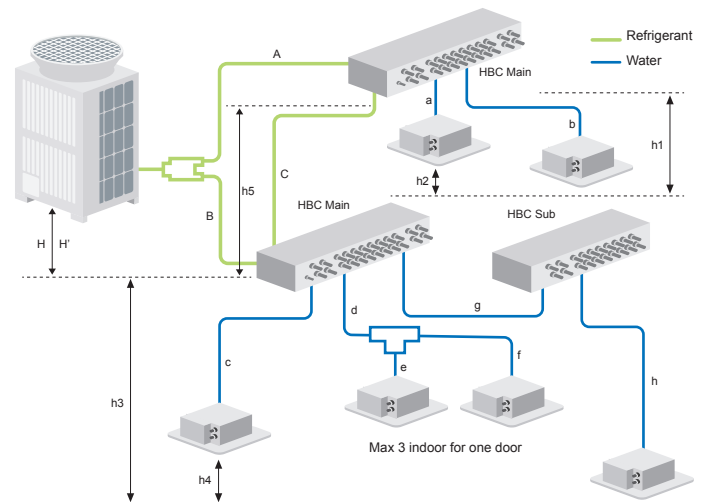

HVRF Systems Line

Indoor units

Ceiling concealed indoor units

PEFY-W VMS-A Medium to low static pressure 198

PEFY-W VMA-A Medium to high static pressure 200

Ceiling cassette indoor units

PLFY-WL VEM-E 4 way airflow type 202

PLFY-WL VFM-E 4 way airflow compact type 203

Floor standing indoor units

PFFY-W VCM-A 204

Wall mounted indoor units

PKFY-WL VLM-E 206



HYDRONICVRF

PEFY-W VMS-A

INDOOR UNITS - Ceiling concealed medium to low static pressure



VALVE
INCLUDED

Technical specifications

MODEL			PEFY-W10VMS-A	PEFY-W15VMS-A	PEFY-W20VMS-A	PEFY-W25VMS-A
Power source			1-phase 220-240 V 50 Hz	1-phase 220-240 V 50 Hz	1-phase 220-240 V 50Hz	1-phase 220-240 V 50Hz
Cooling capacity*1		kW	1.2	1.7	2.2	2.8
		BTU/h	4,100	5,800	7,500	9,600
Heating capacity*1		kW	1.4	1.9	2.5	3.2
		kcal/h	1,200	1,600	2,200	2,800
		BTU/h	4,800	6,500	8,500	10,900
Power input	Cooling	kW	0.020	0.025	0.030	0.035
	Heating	kW	0.020	0.025	0.030	0.035
External finish			Galvanized steel plate	Galvanized steel plate	Galvanized steel plate	Galvanized steel plate
External dimension		HxWxD	200 x 790 x 700	200 x 790 x 700	200 x 790 x 700	200 x 790 x 700
Net weight		kg	19 (42)	19 (42)	19 (42)	19 (42)
Heat exchanger			Cross fin (Aluminum fin and copper tube)			
FAN	Type x Quantity		Sirocco fan x 2	Sirocco fan x 2	Sirocco fan x 2	Sirocco fan x 2
	External static press.*2	Pa	<5> - 15 - <35> - <50>	<5> - 15 - <35> - <50>	<5> - 15 - <35> - <50>	<5> - 15 - <35> - <50>
	Air flow rate	m3/min	(Low-Mid-High) 4.0 - 4.5 - 5.0	(Low-Mid-High) 5.0 - 5.5 - 7.0	(Low-Mid-High) 5.5 - 6.5 - 7.5	(Bassa - Media - Alta) 5.5 - 6.5 - 8.5
Motor	Type		Motore DC	Motor DC	Motor DC	Motor DC
	Output	kW	0.096	0.096	0.096	0.096
Sound pressure level			(Low-Mid-High)	(Low-Mid-High)	(Low-Mid-High)	(Low-Mid-High)
		dB <A>	20-22-23	22-24-25	23-24-26	23-24-28
Air filter			PP honeycomb fabric	PP honeycomb fabric	PP honeycomb fabric	PP honeycomb fabric
Water piping diameter	Inlet	mm I.D.	20	20	20	20
	Outlet	mm I.D.	20	20	20	20
Field drain pipe size		mm	O.D.32 (1-1/4)	O.D.32 (1-1/4)	O.D.32 (1-1/4)	O.D.32 (1-1/4)

*1 The heating/cooling capacity indicates the maximum value during operation under the following conditions:

Cooling: indoor 27°C DB / 19°C WBT, outdoor 35°C DB. Heating: indoor 20°C DB, outdoor 7°C DB. Length of pipes: 7.5 m. Height difference: 0 m.

*2 The external static pressure is factory set to 15 Pa for the PEFY-W VMS-A model

The HVRF **W** indoor units can be connected to both **HVRF Y** and **R2** systems.

Technical specifications					
MODEL			PEFY-W32VMS-A	PEFY-W40VMS-A	PEFY-W50VMS-A
Power source			1-phase 220-240 V 50 Hz	1-phase 220-240 V 50 Hz	1-phase 220-240 V 50Hz
Cooling capacity*1		kW	3.6	4.5	5.6
		BTU/h	12,300	15,400	19,100
Heating capacity*1		kW	4.0	5.0	6.3
		kcal/h	3,400	4,300	5,400
		BTU/h	13,600	17,100	21,500
Power input	Cooling	kW	0.040	0.045	0.070
	Heating	kW	0.040	0.045	0.070
External finish			Galvanized steel plate	Galvanized steel plate	Galvanized steel plate
External dimension		HxWxD	200 x 790 x 700	200 x 990 x 700	200 x 990 x 700
Net weight		kg	19.5 (45)	23.5 (53)	23.5 (53)
Heat exchanger			Cross fin (Aluminum fin and copper tube)		
FAN	Type x Quantity		Sirocco fan x 2	Sirocco fan x 3	Sirocco fan x 3
	External static press.*2	Pa	<5> - 15 - <35> - <50>	<5> - 15 - <35> - <50>	<5> - 15 - <35> - <50>
	Air flow rate	m3/min	(Low-Mid-High) 5.5 - 6.5 - 9.0	(Low-Mid-High) 8.0 - 9.5 - 11.0	(Low-Mid-High) 9.5 - 12.0 - 14.5
Motor	Type		Motor DC	Motor DC	Motor DC
	Output	kW	0.096	0.096	0.096
Sound pressure level			(Low-Mid-High)	(Low-Mid-High)	(Low-Mid-High)
		dB <A>	24-25-31	24-25-28	25-29-33
Air filter			PP honeycomb fabric	PP honeycomb fabric	PP honeycomb fabric
Water piping diameter	Inlet	mm I.D.	20	20	20
	Outlet	mm I.D.	20	20	20
Field drain pipe size		mm	O.D.32 (1-1/4)	O.D.32 (1-1/4)	O.D.32 (1-1/4)

*1 The heating/cooling capacity indicates the maximum value during operation under the following conditions:
Cooling: indoor 27°C DB / 19°C WBT, outdoor 35°C DB. Heating: indoor 20°C DB, outdoor 7°C DB. Length of pipes: 7.5 m. Height difference: 0 m.
*2 The external static pressure is factory set to 15 Pa for the PEFY-W VMS-A model
The HVRF W indoor units can be connected to both HVRF Y and R2 systems.

Indoor unit	Connectivity with outdoor unit
W Model	R2 + HBC Series Y Series + Idronic Unit

The table below summarizes the connectivity between different combinations of indoor units for HVRF - R2 systems

HVRF-R2 outdoor unit	Indoor unit			Connectivity
	A	B	C	
	WLV	W	-	Connectible
	WLV	WL	W	Not connectible
	WLV	W	WP	Not connectible
	WL	W	-	Not connectible
	WL	WP	W	Not connectible
	W	WP	-	Not connectible

WLV = Indoor Unit Type WL with optional valve kit
WL = Indoor Unit Type WL without optional valve kit
WP = Indoor Unit Type WP (without integrated valve and not compatible with the optional valve kit)
W = Indoor Unit Type W (With integrated valve)

In an HVRF-R2 system, if a valve kit is connected to any of the WL indoor units, all other indoor units must also have a valve.
The valve kit is required to use the HVRF-Y system.

PEFY-W VMA-A

INDOOR UNITS - Ceiling concealed medium to high static pressure

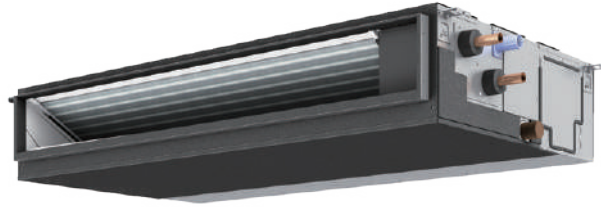

VALVE
INCLUDED

Technical specifications

MODEL			PEFY-W20VMA-A	PEFY-W25VMA-A	PEFY-W32VMA-A	PEFY-W40VMA-A	PEFY-W50VMA-A
Power source			1-phase 220-240 V 50 Hz	1-phase 220-240 V 50 Hz	1-phase 220-240 V 50Hz	1-phase 220-240 V 50Hz	1-phase 220-240 V 50Hz
Cooling capacity*1		kW	2.2	2.8	3.6	4.5	5.6
		BTU/h	7,500	9,600	12,300	15,400	19,100
Heating capacity*1		kW	2.5	3.2	4.0	5.0	6.3
		kcal/h					
		BTU/h	8,500	10,900	13,600	17,100	21,500
Power input	Cooling	kW	0.032	0.032	0.044	0.047	0.093
	Heating	kW	0.030	0.030	0.042	0.045	0.091
External finish			Galvanized steel plate	Galvanized steel plate	Galvanized steel plate	Galvanized steel plate	Galvanized steel plate
External dimension		HxWxD	250 x 700 x 732			250 x 900 x 732	250 x 1,100 x 732
Net weight		kg	22 (49)	22 (49)	22 (49)	26 (58)	30 (67)
Heat exchanger			Cross fin (Aluminum fin and copper tube)				
FAN	Type x Quantity		Sirocco fan x 1	Sirocco fan x 1	Sirocco fan x 2	Sirocco fan x 2	Sirocco fan x 2
	External static press.*2	Pa	35 - <50> - <70> - <100> - <150>				
	Air flow rate	m3/min	(Low-Mid-High) 6.0 - 7.5 - 8.5	(Low-Mid-High) 6.0 - 7.5 - 8.5	(Low-Mid-High) 7.5 - 9.0 - 10.5	(Low-Mid-High) 10.0 - 12.0 - 14.0	(Low-Mid-High) 14.5 - 18.0 - 21.0
Motor	Type		Motor DC	Motor DC	Motor DC	Motor DC	Motor DC
	Output	kW	0.085	0.085	0.085	0.121	0.121
Sound pressure level			(Low-Mid-High) 21-25-27	(Low-Mid-High) 21-25-27	(Low-Mid-High) 23-27-30	(Low-Mid-High) 23-28-31	(Low-Mid-High) 26-31-35
Air filter			PP honeycomb fabric				
Water piping diameter	Inlet	mm I.D.	20	20	20	20	20
	Outlet	mm I.D.	20	20	20	20	20
Field drain pipe size		mm	O.D.32(1-1/4)	O.D.32(1-1/4)	O.D.32(1-1/4)	O.D.32(1-1/4)	O.D.32(1-1/4)

*1 The heating/cooling capacity indicates the maximum value during operation under the following conditions:
Cooling: indoor 27°C DB / 19°C WBT, outdoor 35°C DB. Heating: indoor 20°C DB, outdoor 7°C DB. Length of pipes: 7.5 m. Height difference: 0 m.

*2 The external static pressure is factory set to 15 Pa for the PEFY-W VMA-A model.
The HVRF **W** indoor units can be connected to both **HVRF Y** and **R2** systems.

Technical specifications

MODEL			PEFY-W63VMA-A	PEFY-W71VMA-A	PEFY-W80VMA-A	PEFY-W100VMA-A	PEFY-W125VMA-A	
Power source			1-phase 220-240 V 50 Hz	1-phase 220-240 V 50 Hz	1-phase 220-240 V 50Hz	1-phase 220-240 V 50Hz	1-phase 220-240 V 50Hz	
Cooling capacity*1		kW		8.0	9.0	11.2	14.0	
		BTU/h	24,200	27,300	30,700	38,200	47,800	
Heating capacity*1		kW	8.0	9.0	10.0	12.5	16.0	
		kcal/h						
Power input		BTU/h	27,300	30,700	34,100	42,700	54,600	
	Cooling	kW	0.093	0.093	0.093	0.142	0.199	
	Heating	kW	0.091	0.091	0.091	0.140	0.197	
External finish			Galvanized steel plate	Galvanized steel plate	Galvanized steel plate	Galvanized steel plate	Lamiera in acciaio galvanizzato	
External dimension		HxWxD	250 x 1,100 x 732				250 x 1,400 x 732	
Net weight		kg	30 (67)	30 (67)	30 (67)	37 (82)	38 (84)	
Heat exchanger			Cross fin (Aluminum fin and copper tube)					
FAN	Type x Quantity		Sirocco fan x 2	Sirocco fan x 2	Sirocco fan x 3	Sirocco fan x 3	Sirocco fan x 3	
	External static press.*2	Pa	40 - <50> - <70> - <100> - <150>				<40> - 50 - <70> - <100> - <150>	
	Air flow rate	m3/min	(Low-Mid-High) 14.5 - 18.0 - 21.0	(Low-Mid-High) 14.5 - 18.0 - 21.0	(Low-Mid-High) 14.5 - 18.0 - 21.0	(Low-Mid-High) 23.0 - 28.0 - 32.0	(Low-Mid-High) 28.0 - 34.0 - 37.0	
Motor	Type		Motore DC	Motore DC	Motore DC	Motore DC	Motore DC	
	Output	kW	0.121	0.121	0.121	0.300	0.300	
Sound pressure level			(Low-Mid-High)	(Low-Mid-High)	(Low-Mid-High)	(Low-Mid-High)	(Low-Mid-High)	
		dB <A>	26-31-35	26-31-35	26-31-35	30-35-38	34-38-40	
Air filter			PP honeycomb fabric					
Water piping diameter	Inlet	mm I.D.	30	30	30	30	30	
	Outlet	mm I.D.	30	30	30	30	30	
Field drain pipe size		mm	O.D.32(1-1/4)	O.D.32(1-1/4)	O.D.32(1-1/4)	O.D.32(1-1/4)	O.D.32(1-1/4)	

*1 The heating/cooling capacity indicates the maximum value during operation under the following conditions:
Cooling: indoor 27°C DB / 19°C WBT, outdoor 35°C DB. Heating: indoor 20°C DB, outdoor 7°C DB. Length of pipes: 7.5 m. Height difference: 0 m.
*2 The external static pressure is factory set to 15 Pa for the PEFY-W VMA-A model.
The HVRF W indoor units can be connected to both HVRF Y and R2 systems.

Indoor unit	Connectivity with outdoor unit
W Model	R2 + HBC Series Y Series + Idronic Unit

The table below summarizes the connectivity between different combinations of indoor units for HVRF - R2 systems

HVRF-R2 outdoor unit	Indoor unit			Connectivity
	A	B	C	
	WL	W	-	Connectible
	WL	WL	W	Not connectible
	WL	W	WP	Not connectible
	WL	W	-	Not connectible
	WL	WP	W	Not connectible
	W	WP	-	Not connectible

WL = Indoor Unit Type WL with optional valve kit
 WL = Indoor Unit Type WL without optional valve kit
 WP = Indoor Unit Type WP (without integrated valve and not compatible with the optional valve kit)
 W = Indoor Unit Type W (With integrated valve)

In an HVRF-R2 system, if a valve kit is connected to any of the WL indoor units, all other indoor units must also have a valve.
 The valve kit is required to use the HVRF-Y system.

PLFY-WL VEM-E

INDOOR UNITS - 4-way cassette 900x900



VALVE EXCLUDED

Technical specifications

MODEL			PLFY-WL32VEM-E	PLFY-WL40VEM-E	PLFY-WL50VEM-E
Power source			1-phase 220-240 V 50 Hz, 1-phase 220 V 60 Hz	1-phase 220-240 V 50 Hz, 1-phase 220 V 60 Hz	1-phase 220-240 V 50 Hz, 1-phase 220 V 60 Hz
Cooling capacity*1		kW	3.6	4.5	5.6
		BTU/h	12,300	15,400	19,100
Heating capacity*1		kW	4.0	5.0	6.3
		kcal/h	3,400	4,300	5,400
		BTU/h	13,600	17,100	21,500
Power input	Cooling	kW	0.03	0.03	0.04
	Heating	kW	0.03	0.03	0.04
External finish			Galvanized steel plate	Galvanized steel plate	Galvanized steel plate
External dimension		HxWxD	258 × 840 × 840	258 × 840 × 840	258 × 840 × 840
Net weight		kg	20 (44)	20 (44)	20 (44)
Heat exchanger				Cross fin (Al fin and Cu pipe)	
FAN	Type x Quantity		Turbo fan × 1	Turbo fan × 1	Turbo fan × 1
	External static press.*2	Pa	-	-	-
	Air flow rate	m3/min	(Low-Mid-High) 14-15-16-17	(Low-Mid-High) 14-15-16-17	(Low-Mid-High) 14-16-18-20
Motor	Type			Motor DC	
	Output	kW	0.050	0.050	0.050
Sound pressure level			(Low-Mid-High)	(Low-Mid-High)	(Low-Mid-High)
		dB <A>	26-27-29-30	26-28-29-31	27-29-31-33
Air filter				PP honeycomb fabric	
Water piping diameter	Inlet	mm I.D.	20	20	20
	Outlet	mm I.D.	20	20	20
Field drain pipe size		mm	O.D.32 (1-1/4)	O.D.32 (1-1/4)	O.D.32 (1-1/4)

*1 The heating/cooling capacity indicates the maximum value during operation under the following conditions:
Cooling: indoor 27°C DB / 19°C WBT, outdoor 35°C DB. Heating: indoor 20°C DB, outdoor 7°C DB. Length of pipes: 7.5 m. Height difference: 0 m.
The HVRF WL indoor units can be connected to both HVRF Y and R2 systems.

Indoor unit	Connectivity with outdoor unit
WL Model	R2 + HBC Series Y Series + Idronic Unit

Valve kit specifications

Model			PAC-SK35VK-E
Dimensions	H × W × D	mm	549 × 201 × 107
Net weight	kg	kg	3.5
Water piping diameter	Inlet	mm I.D.	20
	Outlet	mm I.D.	20

*PAC-SK04VK-E phase-out after stock end

The table below summarizes the connectivity between different combinations of indoor units for HVRF - R2 systems

HVRF-R2 outdoor unit	Indoor unit			Connectivity
	A	B	C	
	WLV	WLV	-	Connectible
	WLV	W	-	Connectible
	WLV	WL	-	Not connectible
	WLV	WP	-	Not connectible
	WLV	WL	W	Not connectible
	WLV	WL	WP	Not connectible
	WLV	W	WP	Not connectible
	WL	WL	-	Connectible
	WL	WP	-	Connectible
	WL	W	-	Not connectible
	WL	WP	W	Not connectible

WLV = Indoor Unit Type WL with optional valve kit
WL = Indoor Unit Type WL without optional valve kit
WP = Indoor Unit Type WP (without integrated valve and not compatible with the optional valve kit)
W = Indoor Unit Type W (With integrated valve)



In an HVRF-R2 system, if a valve kit is connected to any of the WL indoor units, all other indoor units must also have a valve.
The valve kit is required to use the HVRF-Y system.

PLFY-WL VFM-E

INDOOR UNITS - 4-way cassette 600x600



VALVE
EXCLUDED

Technical specifications

MODEL			PLFY-WL10VFM-E	PLFY-WL15VFM-E	PLFY-WL20VFM-E	PLFY-WL25VFM-E	PLFY-WL32VFM-E
Power source			1-phase 220-240 V 50 Hz, 1-phase 220 V 60 Hz	1-phase 220-240 V 50 Hz, 1-phase 220 V 60 Hz	1-phase 220-240 V 50 Hz, 1-phase 220 V 60 Hz	1-phase 220-240 V 50 Hz, 1-phase 220 V 60 Hz	1-phase 220-240 V 50 Hz, 1-phase 220 V 60 Hz
Cooling capacity*1		kW	1.2	1.7	2.2	2.8	3.6
		BTU/h	4,100	5,800	7,500	9,600	12,300
Heating capacity*1		kW	1.4	1.9	2.5	3.2	4.0
		kcal/h	1,200	1,600	2,200	2,800	3,400
		BTU/h	4,800	6,500	8,500	10,900	13,600
Power input	Cooling	kW	0.02	0.02	0.02	0.03	0.04
	Heating	kW	0.02	0.02	0.02	0.03	0.04
External finish			Galvanized steel plate				
External dimension		HxWxD	208 × 570 × 570				
Net weight		kg	13 (29)	13 (29)	14 (31)	14 (31)	14 (31)
Heat exchanger			Cross fin (Al fin and Cu pipe)				
FAN	Type x Quantity		Turbo fan × 1	Turbo fan × 1	Turbo fan × 1	Turbo fan × 1	Turbo fan × 1
	External static press.*2	Pa	-	-	-	-	-
	Air flow rate		(Low-Mid-High)	(Low-Mid-High)	(Low-Mid-High)	(Low-Mid-High)	(Low-Mid-High)
		m3/min	6.0-6.5-7.0	6.0-7.0-8.0	6.5-7.0-8.0	6.5-7.5-9.0	6.5-9.0-12.0
Motor	Type		Motore DC	Motore DC	Motore DC	Motore DC	Motore DC
	Output	kW	0.050	0.050	0.050	0.050	0.050
Sound pressure level			(Low-Mid-High)	(Low-Mid-High)	(Low-Mid-High)	(Low-Mid-High)	(Low-Mid-High)
		dB <A>	25-26-27	25-26-29	27-29-31	27-30-34	27-33-41
Air filter			PP honeycomb fabric				
Water piping diameter	Inlet	mm I.D.	20	20	20	20	20
	Outlet	mm I.D.	20	20	20	20	20
Field drain pipe size		mm	O.D.32 (1-1/4)	O.D.32 (1-1/4)	O.D.32 (1-1/4)	O.D.32 (1-1/4)	O.D.32 (1-1/4)

*1 The heating/cooling capacity indicates the maximum value during operation under the following conditions:
Cooling: indoor 27°C DB / 19°C WBT, outdoor 35°C DB. Heating: indoor 20°C DB, outdoor 7°C DB. Length of pipes: 7.5 m. Height difference: 0 m.
The HVRF WL indoor units can be connected to both HVRF Y and R2 systems.

Indoor unit	Connectivity with outdoor unit
WL Model	R2 + HBC Series Y Series + Idronic Unit

Valve kit specifications			
Model	PAC-SK35VK-E		
Dimensions	H × W × D	mm	549 × 201 × 107
Net weight	kg	kg	3.5
Water piping diameter	Inlet	mm I.D.	20
	Outlet	mm I.D.	20

*PAC-SK04VK-E phase-out after stock end

The table below summarizes the connectivity between different combinations of indoor units for HVRF - R2 systems

HVRF-R2 outdoor unit	Indoor unit			Connectivity
	A	B	C	
	WLV	WLV	-	Connectible
	WLV	W	-	Connectible
	WLV	WL	-	Not connectible
	WLV	WP	-	Not connectible
	WLV	WL	W	Not connectible
	WLV	WL	WP	Not connectible
	WLV	W	WP	Not connectible
	WL	WL	-	Connectible
	WL	WP	-	Connectible
	WL	W	-	Not connectible
	WL	WP	W	Not connectible

WLV = Indoor Unit Type WL with optional valve kit
WL = Indoor Unit Type WL without optional valve kit
WP = Indoor Unit Type WP (without integrated valve and not compatible with the optional valve kit)
W = Indoor Unit Type W (With integrated valve)



In an HVRF-R2 system, if a valve kit is connected to any of the WL indoor units, all other indoor units must also have a valve.
The valve kit is required to use the HVRF-Y system.

PFFY-W VCM-A

INDOOR UNITS - Floor standing concealed



VALVE INCLUDED

Technical specifications

MODEL			PFFY-W20VCM-A	PFFY-W25VCM-A	PFFY-W32VCM-A	PFFY-W40VCM-A	PFFY-W50VCM-A
Power source			1-phase 220-240 V 50 Hz	1-phase 220-240 V 50 Hz	1-phase 220-240 V 50Hz	1-phase 220-240 V 50 Hz	1-phase 220-240 V 50 Hz
Cooling capacity*1		kW	2.2	2.8	3.6	4.5	5.6
		BTU/h	7,500	9,600	12,300	15,400	19,100
Heating capacity*1		kW	2.5	3.2	4.0	5.0	6.3
		kcal/h	2,200	2,800	3,400	4,300	5,400
		BTU/h	8,500	10,900	13,600	17,100	21,500
Power input	Cooling	kW	0.022	0.029	0.035	0.038	0.062
	Heating	kW	0.022	0.029	0.035	0.038	0.062
External finish			Galvanized steel plate				
External dimension		HxWxD	615 (690) x 700 x 200	615 (690) x 700 x 200	615 (690) x 700 x 200	615 (690) x 900 x 200	615 (690) x 900 x 200
Net weight		kg	18.5 (42)	18.5 (42)	19 (42)	23 (51)	23 (51)
Heat exchanger			Cross fin (Al fin and Cu pipe)				
FAN	Type x Quantity		Sirocco fan x 2	Sirocco fan x 2	Sirocco fan x 2	Sirocco fan x 3	Sirocco fan x 3
	External static press.*2	Pa	<0> - 10 - <40> - <60>	<0> - 10 - <40> - <60>	<0> - 10 - <40> - <60>	<0> - 10 - <40> - <60>	<0> - 10 - <40> - <60>
	Air flow rate	m3/min	(Low-Mid-High) 5.0 - 6.0 - 7.0	(Low-Mid-High) 5.5 - 7.0 - 8.5	(Low-Mid-High) 6.5 - 7.5 - 9.0	(Low-Mid-High) 8.0 - 9.5 - 11.0	(Low-Mid-High) 10.5 - 12.5 - 14.5
Motor	Type		Motor DC				
	Output	kW	0.096	0.096	0.096	0.096	0.096
Sound pressure level			(Low-Mid-High)	(Low-Mid-High)	(Low-Mid-High)	(Low-Mid-High)	(Low-Mid-High)
		dB <A>	21-23-26	22-26-30	25-28-32	25-27-30	28-32-35
Air filter			PP honeycomb fabric				
Water piping diameter	Inlet	mm I.D.	20	20	20	20	20
	Outlet	mm I.D.	20	20	20	20	20
Field drain pipe size		mm	O.D.32 (1-1/4)	O.D.32 (1-1/4)	O.D.32 (1-1/4)	O.D.32 (1-1/4)	O.D.32 (1-1/4)

*1 The heating/cooling capacity indicates the maximum value during operation under the following conditions:
Cooling: indoor 27°C DB / 19°C WBT, outdoor 35°C DB. Heating: indoor 20°C DB, outdoor 7°C DB. Length of pipes: 7.5 m. Height difference: 0 m.

*2 The external static pressure is factory set to 20 Pa for the PFFY-WP VLRMM-E Model.
The HVRF **W** indoor units can be connected to both **HVRF Y** and **R2** systems.
Indoor unit connections 3/4" thread.

Indoor unit	Connectivity with outdoor unit
W Model	R2 + HBC Series Y Series + Idronic Unit

The table below summarizes the connectivity between different combinations of indoor units for HVRF - R2 systems

HVRF-R2 outdoor unit	Indoor unit			Connectivity
	A	B	C	
	WLV	W	-	Connectible
	WLV	WL	W	Not connectible
	WLV	W	WP	Not connectible
	WL	W	-	Not connectible
	WL	WP	W	Not connectible
	W	WP	-	Not connectible

WLV =Indor Unit Type WL with optional valve kit
WL = Indor Unit Type WL without optional valve kit
WP = Indoor Unit Type WP (without integrated valve and not compatible with the optional valve kit)
W = Indoor Unit Type W (With integrated valve)

In an HVRF-R2 system, if a valve kit is connected to any of the WL indoor units, all other indoor units must also have a valve.
The valve kit is required to use the HVRF-Y system.



PKFY-WL VLM-E

INDOOR UNITS - Wall-mounted



VALVE
EXCLUDED

Technical specifications

MODEL			PKFY-WL10VLM-E	PKFY-WL15VLM-E	PKFY-WL20VLM-E
Power source			1-phase 220-240 V 50 Hz, 1-phase 220 V 60 Hz	1-phase 220-240 V 50 Hz, 1-phase 220 V 60 Hz	1-phase 220-240 V 50 Hz, 1-phase 220 V 60 Hz
Cooling capacity*1		kW	1.2	1.7	2.2
		BTU/h	4,100	5,800	7,500
Heating capacity*1		kW	1.4	1.9	2.5
		kcal/h	1,200	1,600	2,200
Power input	Cooling	kW	0.02	0.02	0.03
	Heating	kW	0.01	0.01	0.02
External finish			Galvanized steel plate		
External dimension		HxWxD	299 × 773 × 237		
Net weight		kg	11(25)	11(25)	11(25)
Heat exchanger			Cross fin (Al fin and Cu pipe)		
FAN	Type x Quantity		Line flow fan x 1	Line flow fan x 1	Line flow fan x 1
	External static press.*2	Pa	-	-	-
	Air flow rate		(Low-Mid-High)	(Low-Mid-High)	(Low-Mid-High)
		m3/min	3.3 - 3.8 - 4.1 - 4.5	3.3 - 3.8 - 4.3 - 4.9	4.0 - 5.0 - 6.0 - 7.0
Motor	Type		Motor DC		
	Output	kW	0.030	0.030	0.030
Sound pressure level			(Low-Mid-High)	(Low-Mid-High)	(Low-Mid-High)
		dB <A>	22-26-28-30	22-26-29-32	22-28-33-36
Air filter			PP honeycomb fabric		
Water piping diameter	Inlet	mm I.D.	Rc 3/4 screw	Rc 3/4 screw	Rc 3/4 screw
	Outlet	mm I.D.	Rc 3/4 screw	Rc 3/4 screw	Rc 3/4 screw
Field drain pipe size		mm	I.D.16 (5/8)	I.D.16 (5/8)	I.D.16 (5/8)

*1 The heating/cooling capacity indicates the maximum value during operation under the following conditions:

Cooling: indoor 27°C DB / 19°C WBT, outdoor 35°C DB. Heating: indoor 20°C DB, outdoor 7°C DB. Length of pipes: 7.5 m. Height difference: 0 m.

The HVRF WL indoor units can be connected to both HVRF Y and R2 systems.

Technical specifications				
MODEL		PKFY-WL25VLM-E	PKFY-WL32VLM-E	PKFY-WL40VLM-E
Power source		1-phase 220-240 V 50 Hz, 1-phase 220 V 60 Hz		1-phase 220-240 V 50 Hz, 1-phase 220 V 60 Hz
Cooling capacity*1		kW	2.8	3.6
		BTU/h	9,600	12,300
Heating capacity*1		kW	3.2	4.0
		kcal/h	2,800	3,400
Power input	Cooling	kW	0.04	0.04
	Heating	kW	0.03	0.03
External finish		Galvanized steel plate		
External dimension		HxWxD	299 × 773 × 237	299 × 898 × 237
Net weight		kg	11(25)	13(29)
Heat exchanger		Cross fin (Al fin and Cu pipe)		
FAN	Type x Quantity		Line flow fan x 1	Line flow fan x 1
	External static press.*2	Pa	-	-
	Air flow rate		(Low-Mid-High)	(Low-Mid-High)
		m3/min	3.3 - 3.8 - 4.1 - 4.5	6.3 - 7.6 - 9.0 - 10.4
Motor	Type		Motor DC	
	Output	kW	0.030	0.030
Sound pressure level			(Low-Mid-High)	(Low-Mid-High)
		dB <A>	22-26-28-30	29-34-38-41
Air filter			PP honeycomb fabric	
Water piping diameter	Inlet	mm I.D.	Rc 3/4 screw	Rc 3/4 screw
	Outlet	mm I.D.	Rc 3/4 screw	Rc 3/4 screw
Field drain pipe size		mm	I.D.16 (5/8)	I.D.16 (5/8)

*1 The heating/cooling capacity indicates the maximum value during operation under the following conditions:
Cooling: indoor 27°C DB / 19°C WBT, outdoor 35°C DB. Heating: indoor 20°C DB, outdoor 7°C DB. Length of pipes: 7.5 m. Height difference: 0 m.
The HVRF WL indoor units can be connected to both HVRF Y and R2 systems.

Indoor unit	Connectivity with outdoor unit
WL Model	R2 + HBC Series Y Series + Idronic Unit

Valve kit specifications			
Model	PAC-SK35VK-E		
Dimensions	H × W × D	mm	549 × 201 × 107
Net weight	kg	kg	3.5
Water piping diameter	Inlet	mm I.D.	20
	Outlet	mm I.D.	20

*PAC-SK04VK-E phase-out after stock end

The table below summarizes the connectivity between different combinations of indoor units for HVRF - R2 systems

HVRF-R2 outdoor unit	Indoor unit			Connectivity
	A	B	C	
	WLV	WLV	-	Connectible
	WLV	W	-	Connectible
	WLV	WL	-	Not connectible
	WLV	WP	-	Not connectible
	WLV	WL	W	Not connectible
	WLV	WL	WP	Not connectible
	WLV	W	WP	Not connectible
	WL	WL	-	Connectible
	WL	WP	-	Connectible
	WL	W	-	Not connectible
	WL	WP	W	Not connectible

WLV =Indor Unit Type WL with optional valve kit
WL = Indor Unit Type WL without optional valve kit
WP = Indoor Unit Type WP (without integrated valve and not compatible with the optional valve kit)
W = Indoor Unit Type W (With integrated valve)



In an HVRF-R2 system, if a valve kit is connected to any of the WL indoor units, all other indoor units must also have a valve.
The valve kit is required to use the HVRF-Y system.

Heating

Hydronic heat pumps

Hybrid systems

VRF HWS & ATW Heating/Cooling/Domestic hot water 212

















ECODAN MULTI - SPLIT - AIR/WATER - AIR/AIR
Heating/Cooling/Domestic hot water 222





Packaged systems

HWHP - CAHV - PACKAGED - AIR/WATER SYSTEM
Heating/Domestic Hot Water 224

HWHP - CRHV - PACKAGED - WATER/WATER SYSTEM
Heating/Domestic Hot Water 230



			Capacity				
			Heating kW	Cooling kW			
					Domestic hot water	Hot water heating	
Hybrid systems							
 MULTI	PUMY-P		12.5 12.5 12.5	12.5 14.0 15.5			
HWS	VRF HWS (Hot Water Supply)		12.5	-			
ATW	VRF ATW (Air To Water)		12.5	11.2			
Packaged systems							
CAHV	HWHP (Hot Water Heat Pump)		45.0	-			
CRHV	HWHP (Hot Water Heat Pump)		60.0	-			

Supply			Functions		Applications and solutions
				Cascade systems automatic control	
Water cooling	Air heating	Air cooling	Heat recovery		

		•	•			AUTONOMOUS SOLUTIONS <ul style="list-style-type: none"> • Residential (villas, apartments) • Offices • Shops/Bars SPA/GYMS
		•	•	•		CENTRALIZED SOLUTIONS <ul style="list-style-type: none"> • Residential (villas, apartments) • Offices • Hotel
•	•	•	•	•		INDUSTRY SHOPPING CENTER SPA/GYM

					•	CENTRALIZED SOLUTIONS <ul style="list-style-type: none"> • Residential (condons) • Offices • Hotel
					•	INDUSTRY SHOPPING CENTER SPA/GYM

VRF HWS & ATW

HYBRID SYSTEM - Heating/Cooling/Domestic hot water



CITY MULTI



WATER HEATING



DOMESTIC HOT WATER



ENERGY RECOVERY



AIR COOLING



AIR HEATING

The scalability, flexibility and modularity of the Ecodan® – VRF HWS & ATW system represents the state of the art in Mitsubishi Electric technology. This solution makes it possible to use a single producer – the VRF outdoor unit – to deliver heating water, cooling water and domestic hot water simultaneously.

Hydronic modules for VRF CITY MULTI systems.

Ecodan® heat pump technology has been used in conjunction with hydronic modules to create systems for the production of domestic hot water (HWS) and heating water for radiator panels (ATW) which are perfectly compatible with the inclusion of both thermal and photovoltaic solar panels in the installation. Systems with electric heat pumps may be used all year round, as their use is not restricted by legislation.

The added comfort of being able to use the air conditioning system in spring and autumn is yet another advantage of these VRF systems. The indoor units of the VRF CITY MULTI system gently cool and dehumidify the interior space in spring, cool and dehumidify in summer, transferring the extracted heat to both the HWS and ATW hydronic modules, and heat the interior gently at cooler times of day in autumns.

HWS hydronic modules are ideal for the production of domestic hot water all year round. They make use of the energy drawn from indoor spaces by the VRF indoor units, as well as supplementary energy provided by solar panels in summer and spring.

ATW hydronic modules provide hot water for radiant panel heating in winter and deliver warm water to heat a pool in summer, contributing to maintaining comfortable temperature conditions and making use of the energy drawn from the indoor space by the VRF indoor units supplemented by heat supplied by thermal solar panels.

In systems with this capability, ATW hydronic modules may also be used to deliver refrigerated water to radiant panels in summer.

TYPICAL APPLICATIONS: HOTEL (ROOMS)



TYPICAL APPLICATIONS: CENTRALIZED RESIDENTIAL SYSTEMS



SOLUTION FOR CLIMATIZATION, HEATING AND DOMESTIC HOT WATER PRODUCTION



- 1 R2 Outdoor Units
- 2 Photovoltaic solar panels
- 3 BC controller
- 4 HWS Hydronic Module
- 5 ATW Hydronic Module
- 6 Domestic hot water accumulator tank fed from HWS
- 7 Hot water inertial accumulator tank fed by ATW

— GREEN REFRIGERANT CIRCUIT
 — RED DOMESTIC HOT WATER CIRCUIT
 — ORANGE HEATING HOT WATER CIRCUIT
 — BLACK POWER CIRCUIT

HWS hydronic module – Hot water supply

Mitsubishi Electric was the first to introduce VRF systems for the production of high temperature hot water (up to 70°C), usable for domestic hot water production. The HWS hydronic module represents a significant, innovative technological breakthrough that uses the most advanced refrigeration technology, and has been conceived to be easily integrable with R2/WR2 series VRF CITY MULTI simultaneous cooling / heating systems.

Heat recovery plays a crucial role in these systems, as the HWS hydronic module may be used to extract heat from rooms where cooling is

required, which would otherwise be vented into the outdoor atmosphere, and then use this heat to contribute to hot water production, adding only the supplementary heat necessary to reach the desired temperature. The HWS hydronic module can produce hot water at temperatures up to 70°C in the return line, with a heating capacity of up to 12.5 kW per module which, however, is scalable in relation to internal demand.

HWS HYDRONIC MODULE – HOT WATER SUPPLY

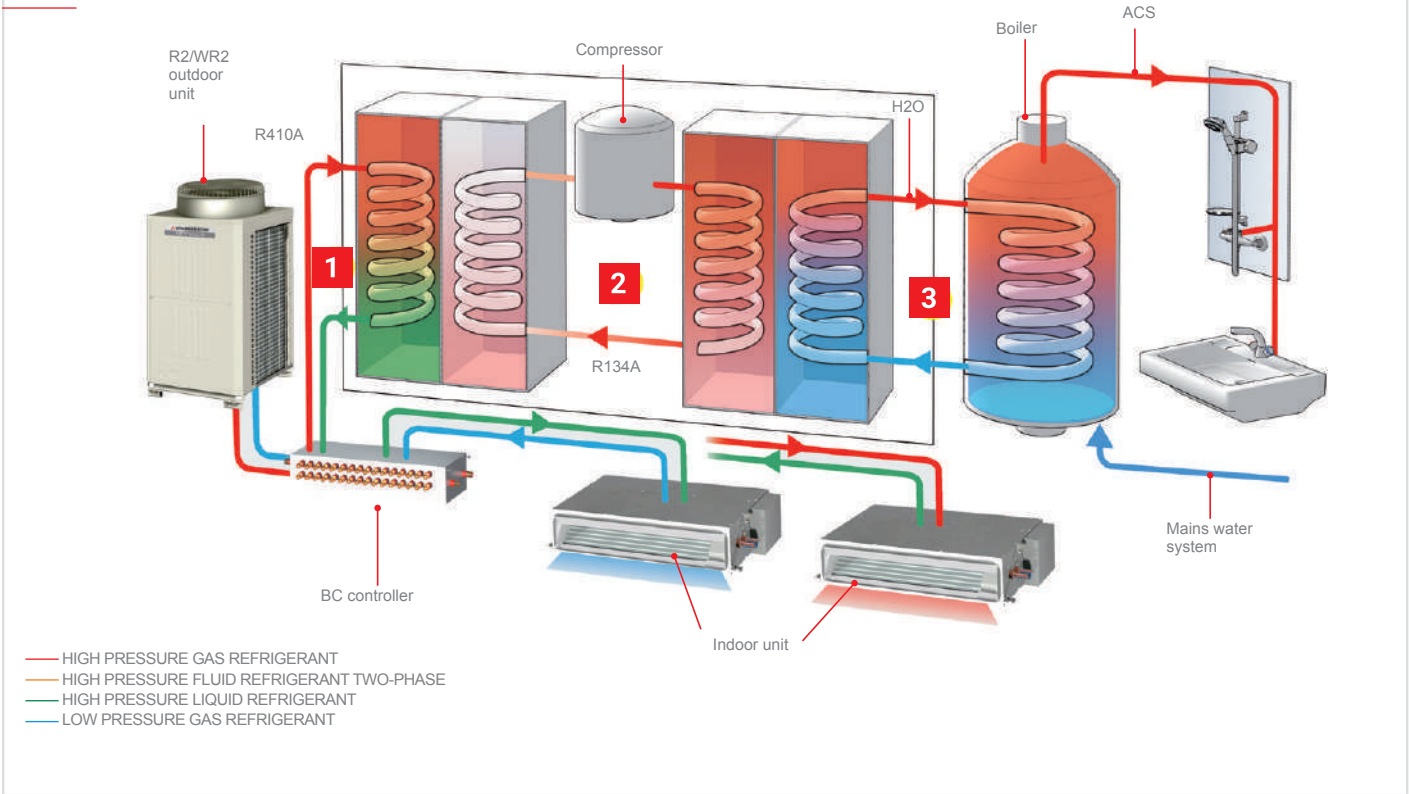

— HIGH PRESSURE GAS REFRIGERANT
 — HIGH PRESSURE FLUID REFRIGERANT TWO-PHASE
 — HIGH PRESSURE LIQUID REFRIGERANT
 — LOW PRESSURE GAS REFRIGERANT

Operating principle of two-stage technology

The HWS hydronic module employs a variant of the two-stage compression principle – a principle that has been known and used for many years, but which, until now, has only been applied in refrigeration systems to reach very low temperatures (as low as -60°C). Mitsubishi Electric has redesigned the two-stage circuit to achieve the opposite effect, for units intended to produce heating power at medium to high temperatures, from 30°C to 70°C. This solution combines superior energy efficiency with high hot water temperatures that are not attainable with the conventional heat pumps currently on the market. As illustrated previously, the HWS hydronic module uses the “free” heat extracted from the air conditioned interior by the heat recovery circuit of the CITY MULTI R2 outdoor units and raises the temperature to the desired value to deliver usable hot water. This double process recovers energy from the system, increasing its overall efficiency, and raises the temperature of the water with minimal energy expenditure.

Advantages of two-stage technology

The two-stage technology employed in the HWS hydronic module offers a number of significant advantages:

- R134a refrigerant in high temperature stage. R134a is a pure HFC refrigerant which is harmless for the stratospheric ozone layer and contributes only marginally to the greenhouse effect. This refrigerant is particularly suitable for high temperature applications.
- R410A refrigerant in low temperature stage. This is also an HFC refrigerant that is harmless to stratospheric ozone, which offers extraordinary efficiency in air conditioning applications.
- Minimal external energy demand, even when the system is operating in air conditioning mode. The heat drawn from the air is used to heat water.
- When the system functions predominantly in air conditioning mode – in summer, for example – hot water is produced with extremely low energy consumption. This makes it possible for the system to attain very high COP values.
- Continuously variable heating power in relation to demand, made possible by the inverter motor scroll compressor, which reduces energy consumption proportionally.
- Compact dimensions and very light weight. These modules may be mounted on walls, even in intermediate positions. Practically zero floor space usage.
- Individual thermal energy consumption billing with field devices.

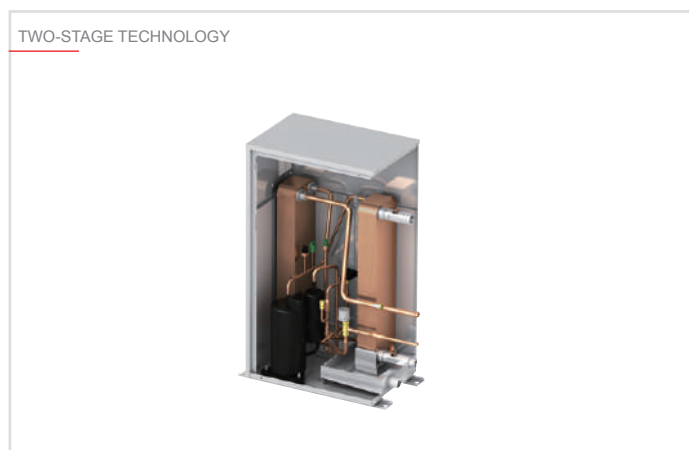

Hybrid systems

The HWS hydronic module may be used to create hybrid systems, with both hydronic modules and VRF direct expansion units. For instance, this makes it possible for the system to produce domestic hot water and heat or cool the air in the indoor space using the most suitable indoor units of the Mitsubishi Electric range (cassette units, ceiling-suspended units, ducted units etc.).

As well as superior energy efficiency, a hybrid system also offers the extraordinary flexibility needed to cater for very diverse situations, which a conventional air conditioner system simply does not.

Control and adjustment system

The HWS hydronic module can be configured for the following operating modes and hot water temperatures:

OPERATING MODE	TEMPERATURE RANGE
Hot water	30 - 70°C
Heating	30 - 50°C
ECO heating	30 - 45°C
Antifreeze	10 - 45°C

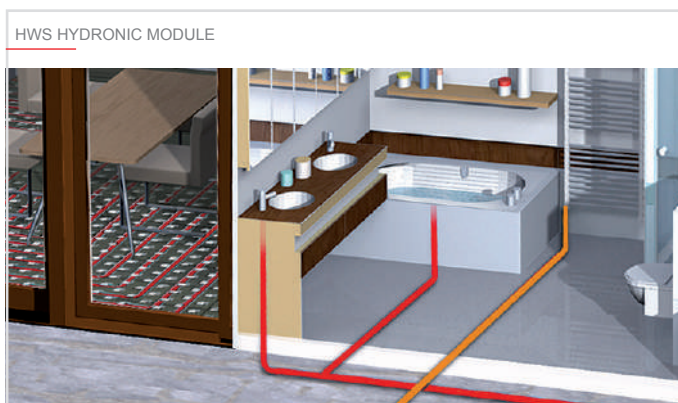



Technical specifications HWS HYDRONIC MODULE

MODEL		PWFY-P100VM-E-BU	
Power			Single-phase, 220-230-240V, 50 Hz/60Hz
Heating power output (nominal)		kW *1	12,5
		kcal/h *1	10,800
		Btu/h *1	42,700
	Power absorption	kW	2,48
	Current consumption	A	11,63 - 11,12 - 10,66
Temp. range in heating mode	PURY Series	Outdoor temp. DB	-20~32°C
	PQRY Series	Water temp. in circuit	10~45°C
	PQRY Series	Temp. in water/glycol circuit (for geothermal applications)	-5~45°C
	PWFY-P VM-E1-BU	Return line water temp.	10~70°C
Connectable outdoor units	Total capacity		50-100% of external unit capacity
	Series		R2 (E)P, WR2
Sound pressure in anechoic chamber	dB <A>		44
Refrigerant circuit piping diameter	Liquid	mm (inches)	ø 9,52 (ø 3/8") brazed
	Gas	mm (inches)	ø 15,88 (ø 5/8") brazed
Water piping diameter	Inlet	mm (inches)	ø 19,05 (R 3/4") screw-on connection
	Delivery	mm (inches)	ø 19,05 (R 3/4") screw-on connection
Drain pipe diameter		mm (inches)	ø 32 (1-1/4")
External finish			Galvanised sheet steel
External dimensions HxLxW		mm	800 (785 without feet) x 450 x 300
Dry weight		kg	60
Compressor	Type		Hermetic scroll compressor with inverter
	Manufacturer		MITSUBISHI ELECTRIC CORPORATION
	Starter method		Inverter
	Power	kW	1
	Lubricant		NEO22
Water in circuit	Nominal	m³/h	0,6 - 2,15
	(entire operating volume)		
Internal circuit protection (R134a)	Overpressure protection		Overpressure sensor, pressure switch calibrated to 3.60 Mpa (601 psi)
	Inverter circuit (COMP)		Overcurrent protection, overheat protection
	Compressor		Outlet temperature protection, overheat protection
Refrigerant	Type / original charge		R134a x1.1kg (0,50lb)
	Controller		LEV
Rated pressure	R410a	MPa	4,15
	R134A	MPa	3,60
	Water	MPa	1
Standard equipment	Manuals		Installation manual, Instruction manuals
	Accessory		Water filter, insulating material

Note:

- * Nominal conditions *1 are subject to EN14511-2:2004(E)
- * Install the module in an environment with a wet bulb temperature not exceeding 32°C
- * Due to continuous improvements made to these products, the specifications given above are subject to modification without prior notification.

* The module is not designed to be installed outdoors.

- *1 Nominal heating conditions Outdoor temp.: 7°C DB/6°C WB
- Nominal heating conditions Outdoor temp.: 7°C DB/6°C WB (45°F DB/43°F WB)
- Pipe Length 7.5 m (24-9/16 feet) – Vertical difference: 0 m (0 feet)

ATW hydronic module – Air to water

Mitsubishi Electric has developed the ATW reversible air-water heat pump hydronic module specifically for hydronic heating and air conditioning systems. The refrigeration side of the module may be connected to VRF CITY MULTI SMALL Y and Y Series outdoor heat pump units, or to R2 heat recovery units. The hydronic side of the module may feed heated underfloor systems or other similar utilities, to provide heating in winter in heat pump mode, or cooling in summer in conditioning mode.

Connecting these modules to R2 Series VRF CITY MULTI heat recovery outdoor units offers extraordinarily levels of efficiency, especially in spring and autumn, with extremely high COP values. The HWS hydronic module can produce hot water at temperatures up to 40°C in the return line (45°C in delivery line), with a heating capacity of up to 12.5 kW per module which, however, is scalable in relation to internal demand.

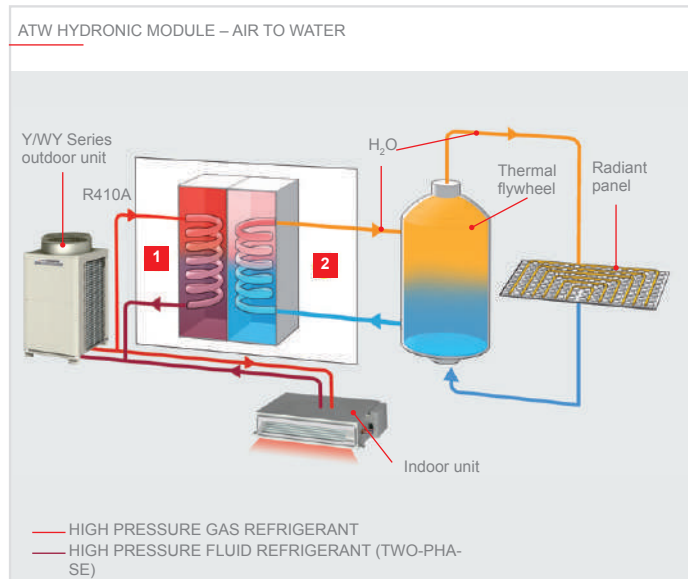

Hybrid systems

Like the HWS module, the ATW hydronic module may be used to create hybrid systems, with both hydronic modules and VRF direct expansion units. For instance, this makes it possible to create a system that can heat certain rooms with radiant panels (a heating solution that is now very popular, as it offers uniform temperatures and quietness) and heat other rooms using appropriate Mitsubishi Electric indoor units (cassette units, wall-mounted units, ducted units etc.). Similarly, conditioning in summer may be performed with a heated underfloor system in rooms where this is installed, and with cooled air in other rooms, via standard VRF indoor units.

This makes it possible to use the most effective treatment solution possible for each interior space, catering for both the requisites of the specific application and the preferences of the user. As well as superior energy efficiency, a hybrid system also offers the extraordinary flexibility needed to cater for very diverse situations, which a conventional conditioning system simply does not.

TYPICAL APPLICATIONS: HOTEL (COMMON AREAS)



TYPICAL APPLICATIONS: CENTRALIZED RESIDENTIAL SYSTEMS (RADIANT PANEL HEATING)



Main features

The functional characteristics of the ATW hydronic module cater for the needs of a very wide variety of different installations:

- nominal heating capacity: 12.5 kW;
- nominal cooling capacity: 11.2 kW;
- outdoor operating temperature range, heating mode: -20°C to +32°C (R2 heat recovery series); -20 to +15.5°C (Y heat pump series);
- outdoor operating temperature range, conditioning mode: -5°C to +46°C (R2 and Y series);
- return hot water temperature range: 10°C to 40°C;
- mains power: single-phase, 230V AC;
- individual thermal energy consumption billing with field devices.

Operating principle

The ATW reversible heat pump hydronic module consists essentially of a brazed plate stainless steel refrigerant-water heat exchanger connected to the VRF CITY MULTI outdoor unit on the refrigeration side, and to the hydronic circuit of the system (radiant panels, radiator units etc.) on the water side. The module is equipped with an electronic expansion valve which modulates the flow of refrigerant in the heat exchanger in response to heating or cooling demand and the demand required by the electronic management and control circuit. The entire system is encased in a housing with compact dimensions and very limited weight comparable to a wall-mounted boiler. The high COP value attained by the ATW hydronic module means that it delivers superior comfort with minimal operating costs, contributing to reducing the CO2 emissions produced for energy production at the power plant. This offers a two-sided advantage as emissions are not only reduced, but also delocalised away from populated areas.

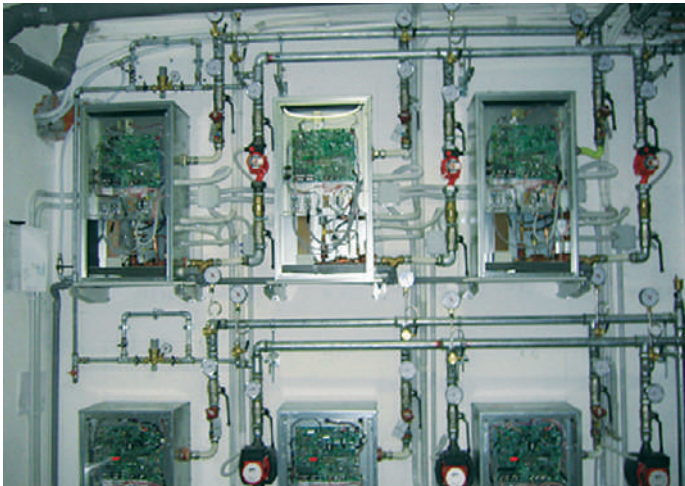

Control and adjustment system

Like the HWS module, the ATW hydronic module is equipped with a sophisticated control system offering a wide choice of functions, selectable in relation to the needs of the installation and the preferences of the user.

The ATW module may be associated with its own independent remote controller (PAR-W21MAA), allowing the user to configure all operating settings, including water temperature, which may be displayed either for the delivery circuit or for the return circuit.

The water temperature reading displayed depends on the type of installation and on the auxiliary controller devices used. The return circuit reading configuration is the most widely used of the two, and allows precise control over the water temperature in the inertial accumulator tank (which is recommended) as a means to balance flows. Once the set temperature is reached, the ATW continues to operate to maintain a constant value.

Note that with this configuration, the delivery temperature is normally higher (max. 45°C) than the set temperature until the set temperature itself is reached.

In installations operating in summer, the ATW produces cold water at a temperature regulated with the same method, based on the primary delivery circuit reading or the return circuit reading.

As the cooling action of the radiant panels only reduces the sensible heat of the interior space, suitable dehumidification systems may also be included in the installation.

The ATW hydronic module can be configured for the following operating modes and hot water temperatures:

MODE	TEMPERATURE RANGE
Heating	30 - 45°C
ECO heating	30 - 45°C
Antifreeze	10 - 45°C
Cooling	10 - 30°C



Technical specifications HWS HYDRONIC MODULE

MODEL		PWFY-EP100VM-E2-AU	
Power			Single-phase, 220-230-240V 50/60Hz
Heating power output (nominal)		kW *1	12,5
		kcal/h *1	10,800
		Btu/h *1	42,700
	Power absorption	kW	0,025
	Current consumption	A	0,138
Temp. range in heating mode	Serie PUMY	Outdoor temp. DB	-
	Serie PUHY	Outdoor temp. DB	-20~15,5°C
	Serie PURY	Outdoor temp. DB	-20~32°C
	Serie PQHY - PQRV	Water temp. in circuit	10~45°C
	Serie PQHY - PQRV	Temp. in water/glycol circuit (for geothermal applications)	-5~45°C
		Return line water temp	10~40°C
Cooling output (nominal)		kW *2	11,2
		kcal/h *2	9,600
		Btu/h *2	38,200
	Power absorption	kW	0,025
	Current consumption	A	0,138
Temp. range in cooling mode	PUMY Series	Outdoor temp. B.S.	-
	PUHY Series	Outdoor temp. B.S.	-5~46°C
	PURY Series	Outdoor temp. B.S.	-5~46°C
	PQHY - PQRV Series	Water temp. in circuit	10~45°C
	PQHY - PQRV Series	Temp. in water/glycol circuit (for geothermal applications)	-5~45°C
		Return line water temp	10~35°C
Connectable outdoor units	Total capacity		50-100% of capacity of OU
	Series		Y (Ecostandard (P), Standard Efficiency (P), High Efficiency (EP)), Zubadan Y, WY, R2 (Standard Efficiency (P), High Efficiency (EP)), WR2
			29 ø 9,52 (ø 3/8") brazed
Sound pressure in anechoic chamber	dB <A>		ø 15,88 (ø 5/8") brazed
Refrigerant circuit piping diameter	Liquid	mm (inches)	ø 19,05 (R 3/4") screw-on connection
	Gas	mm (inches)	ø 19,05 (R 3/4") screw-on connection
Water piping diameter	Inlet	mm (inches)	ø 32 (1-1/4")
	Delivery	mm (inches)	Galvanised sheet steel
Drain pipe diameter		mm (inches)	800 (785 without feet) x 450 x 300
External finish			36
External dimensions HxLxW		mm	1,8-4,30
Dry weight		kg	
Water in circuit	Nominal	m³/h	4,15
	(entire operating volume)		1
Rated pressure	R410A	MPa	Installation manual, Instruction manuals
	Water	MPa	
Standard equipment	Manuals		Water filter, insulating material, 2x external signal connectors, plumbing fittings for filter, flow regulator
	Accessory		

Note:
 * Nominal conditions *1 and 2* are subject to EN14511-2:2004(E)
 * Install the module in an environment with a wet bulb temperature not exceeding 32°C
 * Due to continuous improvements made to these products, the specifications given above are subject to modification without prior notification.
 * The module is not designed to be installed outdoors.

*1 Nominal heating conditions
 Outdoor temp.: 7°C DB/6°C WB (45°F DB/43°F WB)
 Pipe length: 7.5 m (24-9/16 feet)
 Vertical difference: 0 m (0 feet)
 Intake water temp.: 30°C
 Water flow rate: 2.15 m³/h (P100) 4.30 m³/h (P200)

*2 Nominal cooling conditions:
 External temp: 35°C DB/(95°F DB)
 Pipe length 7.5 m (24-9/16 feet)
 Vertical difference: 0 m (0 feet)
 Intake water temp.: 23°C
 Water flow rate: 1.93 m³/h (P100) 3.86 m³/h (P200)



SCHEMATIC: ECODAN® VRF HWS & ATW (SIMULTANEOUS HEATING, COOLING AND DOMESTIC HOT WATER PRODUCTION)

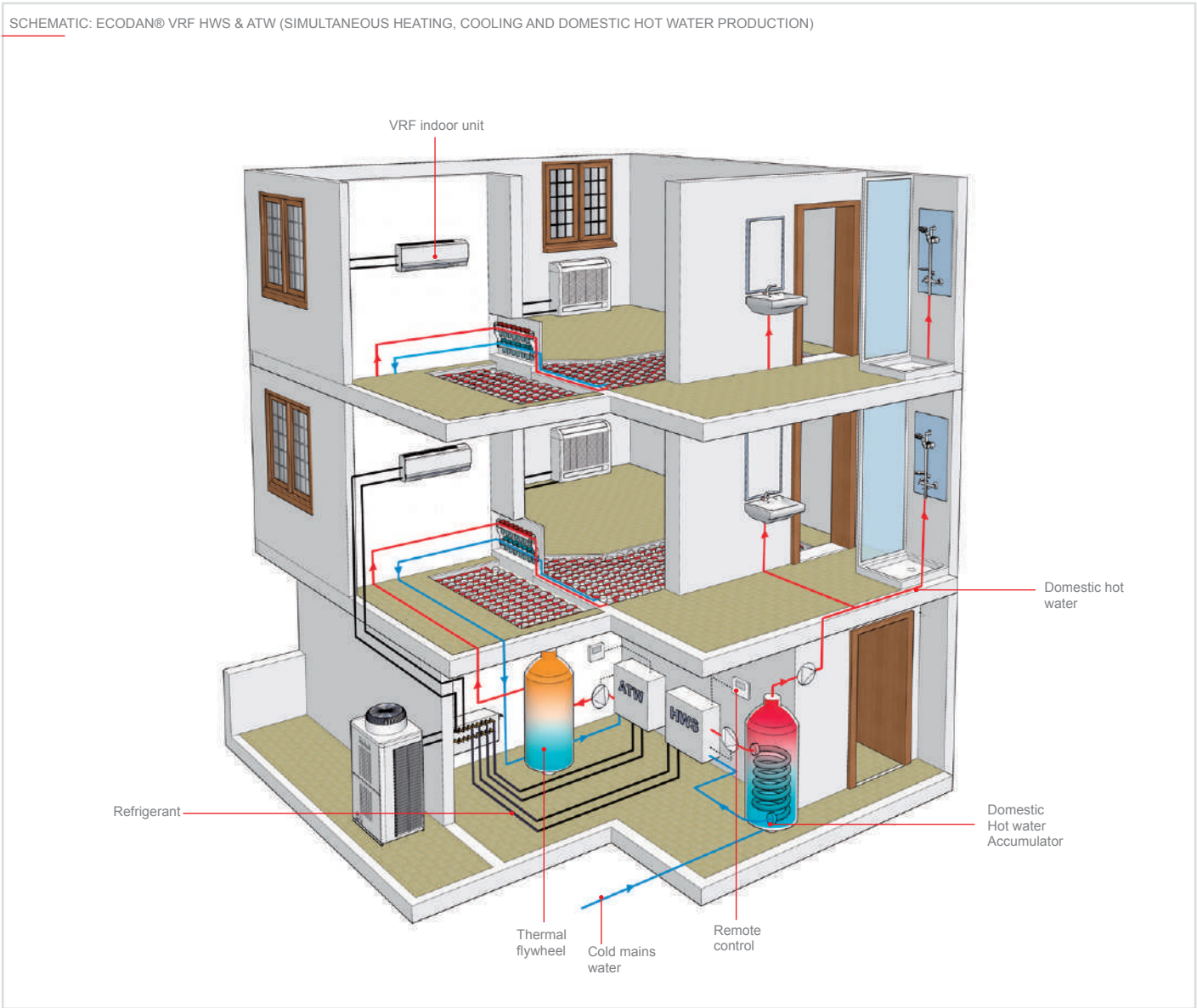

200% EXTENDED CONNECTIVITY FUNCTION



Y / WY Line



Y SERIES HEAT PUMP UNITS

With Y Series outdoor units, this function is only applicable in mixed installations and allows the connection of indoor units (air heating or cooling) and an Ecodan@ ATW hydronic module (water heating) with a total capacity index up to 200% of the capacity of the outdoor unit.*

BC Controller

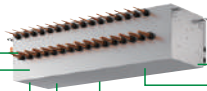

R2 / WR2 Line

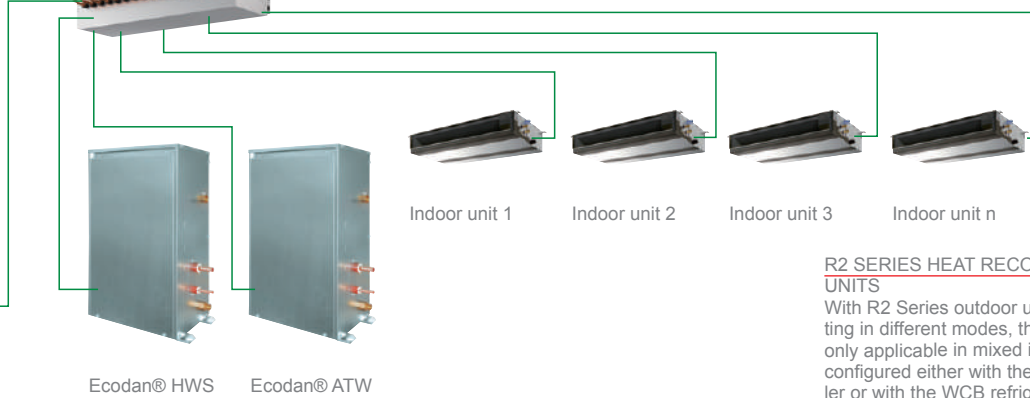

R2 SERIES HEAT RECOVERY UNITS

With R2 Series outdoor units operating in different modes, the function is only applicable in mixed installations configured either with the BC Controller or with the WCB refrigerant-water connection box, and permits the connection of indoor units (air heating and cooling) and Ecodan@ HWS&ATW hydronic modules (DHW production and water heating) with a total capacity index up to 200% of the capacity of the outdoor unit.*

WCB

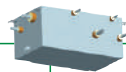

R2 / WR2 Line



*For detailed informations, please contact your representative



ECODAN MULTI

SPLIT - AIR/WATER - AIR/AIR - Heating/Cooling/Domestic hot water



WATER HEATING



DOMESTIC HOT WATER



AIR COOLING



AIR HEATING

Ecodan® Multi is a hybrid Air/Air, Air/Water system that combines the flexibility of a multisplit system with the

convenience of a hydronic heat pump that can produce hot water for heating and domestic use.

SMALL Y LAYOUT WITH ECODAN

— REFRIGERANT
— WATER

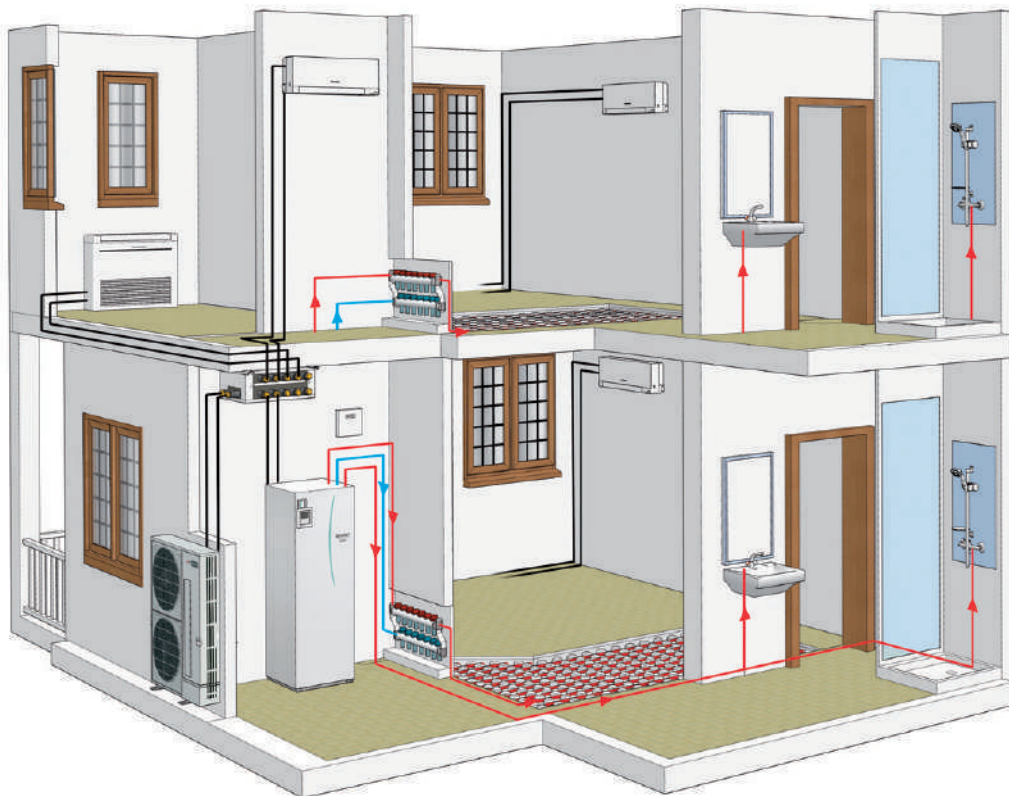

HWHP - CAHV

PACKAGED - AIR/WATER SYSTEM - Heating/Domestic Hot Water



WATER HEATING



DOMESTIC HOT WATER

The Ecodan® - Packaged HWHP (Hot Water Heat Pump) system consists of an outdoor monoblock air condensing unit which produces very high volumes of high-temperature hot water.

Technology

COP
Over 4*

The flash-injection circuit designed for the VRF CITY MULTI ZUBADAN Y system (a heat pump system for very cold climates) is installed in the latest packaged Hot Water Heat Pump CAHV system. By using this advanced injection system and highly efficient compressors, the CAHV packaged system can deliver high-temperature hot water up to 70°C, and ensures fewer losses in terms of performance and capacity at very low outdoor temperatures.

Packaged AtW heat pumps for hot water

Mitsubishi Electric has been designing and manufacturing packaged heat pumps for hot water for the commercial sector since 1970.

The company was one of the first manufacturers in Japan to use heat pump technology to produce hot water, and was also the first to develop a range of solutions operating with R407C, which even then could produce high-temperature hot water up to 70°C, sufficient to instantly eliminate legionella bacteria.

Our products are still used today in industrial processes requiring high volumes of high-temperature water.

Our Hot Water Heat Pump systems are used in hotels, hospitals and care homes, testifying to their superior reliability.

As a leading manufacturer of domestic hot water production systems, we are proud to introduce the efficient Air to Water packaged heat pump system.

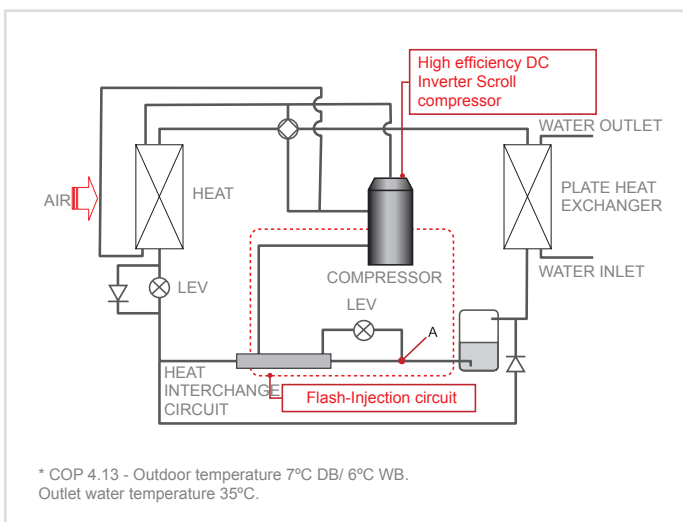

* COP 4.13 - Outdoor temperature 7°C DB/ 6°C WB.
Outlet water temperature 35°C.



Class-beating heating capacity

**MAX.
70kW
Over***

The CAHV packaged system offers unrivalled flexibility with 2 operating modes to cater for every possible need - Efficiency Mode (COP) and Capacity Mode. In Capacity Mode the system can deliver a maximum capacity that exceeds 70 kW, while Efficiency Mode (COP) is extremely effective for maximising energy efficiency in all operating conditions, and reducing CO2 emissions as a result.

* Outdoor temperature 20°C DB, Outlet water temperature 35°C. Relative humidity 85% in capacity mode.

Efficiency mode (COP)

Outlet water temperature 35°C.	Outdoor temperature °C DB	-20	-10	0	7	20
	Capacity kW	31.9	40.3	42.7	45.0	45.0

Capacity Mode

Outlet water temperature 35°C.	Outdoor temperature °C DB	-20	-10	0	7	20
	Capacity kW	31.9	40.3	42.7	63.4	73.9

Operation guaranteed at temperatures as low as -20 °C

Operable even at -20°C

The CAHV packaged system is capable of operating at outdoor temperatures between -20°C and 40°C, producing high-temperature hot water (65°C) even on the coldest days of the year. In the defrost cycle, the two system compressors operate in turn, limiting the drop in delivery temperature.

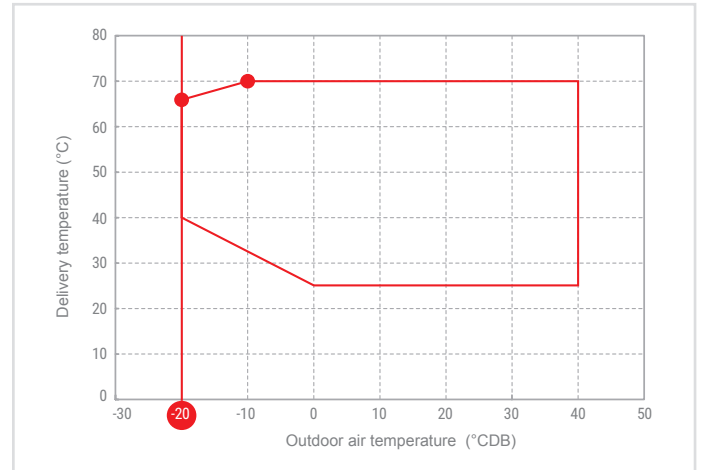

Backup and rotation functions

Backup Function
Rotation Function

The CAHV packaged system is highly reliable thanks to its Backup* function, which ensures that if one of the compressors in an individual system fails, the other will continue operating to avoid the inconvenience of the system shutting down completely. Obviously

heat capacity is halved under these conditions.

Another key function for ensuring uniform operation and optimal compressor lifetime in CAHV packaged systems in multiple configurations is the Rotation function. This ensures that when an installation has two or more systems, the individual systems will operate in turn if thermal demand does not require simultaneous operation.

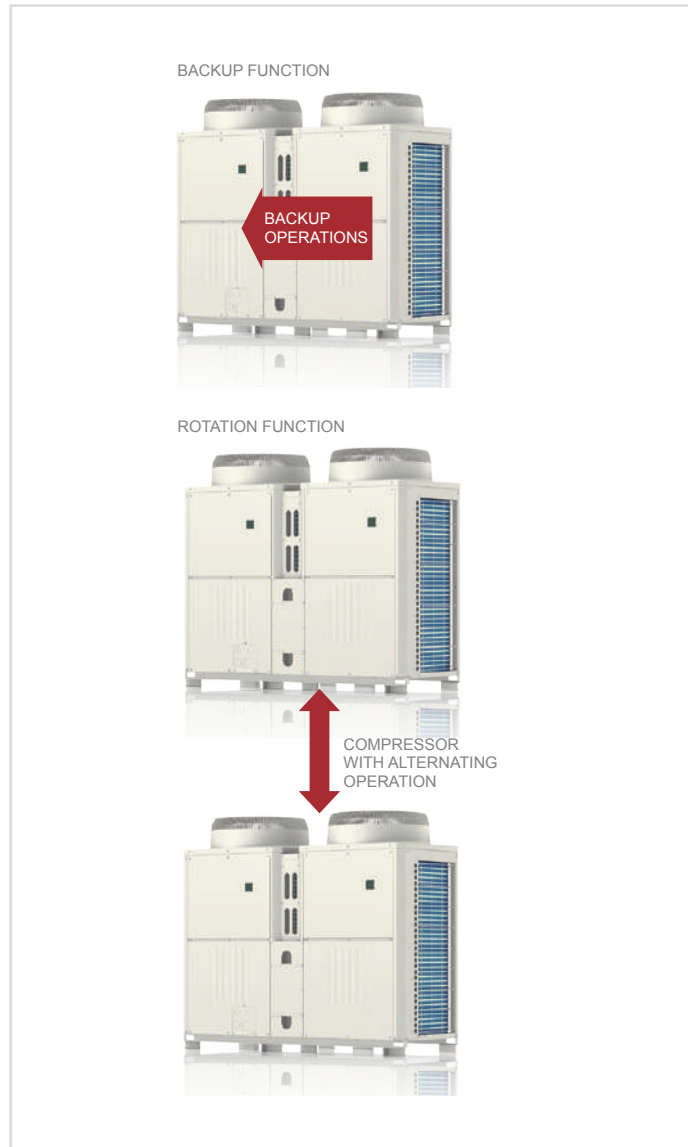

Cascade systems

When the demand for large volumes of hot water production is high, a flexible, modular thermal power installation may be created with up to 16 CAHV packaged systems, for a maximum output of up to 720 kW. This solution offers a high level of modularity thanks to the 2 DC scroll inverter compressors installed in an individual system, ensuring that thermal power is adjusted progressively and with extreme precision in relation to actual hot water demands. This optimises the operation of the entire installation, with only part of the CAHV packaged system operating under medium-load conditions during typical spring and autumn temperatures. A malfunction in one or several CAHV packaged systems will not compromise the operation of the other systems in the installation, ensuring safety and continuous operation.



High-pressure fans

60 Pa
External static pressure

The latest fan technology used in the CAHV packaged system enables the creation of ducted installations, further increasing system flexibility. The external static pressure of the fans can be set at between 0 Pa and 60 Pa.

External remote control

Wide variety of external input/output

A wide choice of analogue and digital inputs and digital outputs available with the system's electronics enables remote control operation (via a BMS, timer or external contacts). The following are just some of the available input signals:

- Option of selecting operating mode and hot water production temperature setpoint, choosing Heating Mode or ECO Heating Mode. The latter mode is particularly advanced, as it uses the outdoor air compensation curve to automatically determine the water delivery setpoint.
- Option of selecting operating mode and hot water production temperature setpoint, choosing Domestic Hot Water Mode or Heating Mode. This makes it possible to configure two different water temperature setpoints, a higher value for domestic hot water production and a lower value for heating. This improves performance at partial loads, as DHW is only produced when required.
- Selecting Efficiency Mode (COP) or Capacity Mode for unit operation. This means system operation can be optimised in relation to demand, increasing power or performance depending on requirements.
- Selecting ON/OFF on the basis of the signals received from the flow regulator switch and the circulation pump, for increased protection of the hydronic circuit and satisfactory system operation.

The following are just some of the available output signals:

- A digital output can be enabled at a selectable minimum water temperature to start an alternative heat generator (boiler, solar panel etc.) to substitute the system if it is OFF.
- Unit defrost signal.

The result is maximum control flexibility, either locally using the dedicated PAR-W21MAA remote controller, or remotely using external contacts.

Control and monitoring functionality with centralised WEB Server controllers

With the M-Net data transmission bus, the CAHV packaged system can interface with the centralised **WEB Server 3D Touch** and **3D Blind Controllers** of the VRF CITY MULTI control system range.

Depending on the application, the CAHV packaged system can therefore interface with a VRF CITY MULTI system to optimise operation when catering for hot water, heating and air conditioning demands, or to manage, monitor and supervise the system in a standalone configuration for applications solely requiring the production of large volumes of hot water. In both cases, the system can be controlled via a 10.4" backlit, colour touchscreen display on the 3DT controller, or via the Internet using the web pages for either centralised controller.



LAYOUT: ECODAN® PACKAGED HWHP CAHV (LOW AND HIGH TEMPERATURE HEATING + DHW)

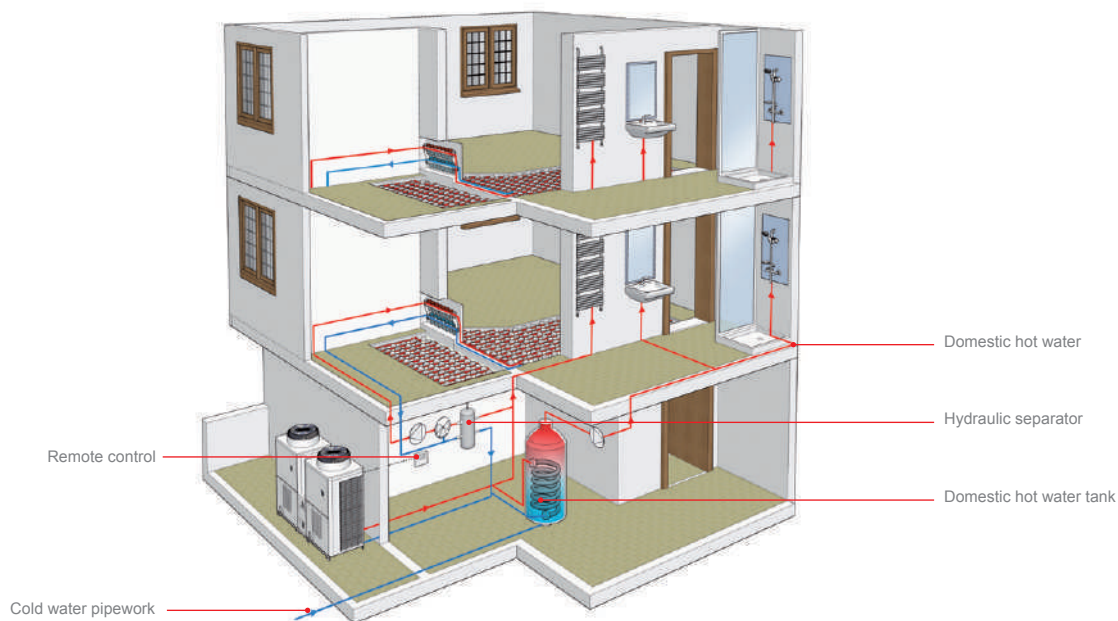

Technical specifications HEATING/COOLING/DOMESTIC HOT WATER

MODEL				CAHV-P500YA-HPB(-BS)	
	Power Supply	Voltage/Freq./Phases	V/Hz/no.	3 phases 380-400-415V; 50/60 Hz	
Spring/Autumn heating	Nominal heating capacity ¹		kW	45,0	
		Absorbed power	kW	12,9	
		Absorbed current	A	21,78-20,69-19,94	
		COP.		3,49	
	Nominal heating capacity ²		kW	45,0	
		Absorbed power	kW	10,9	
		Absorbed current	A	10,6	
		COP.		4,13	
	Nominal heating capacity ³		kW	45,0	
		Absorbed power	kW	25,6	
		Absorbed current	A	43,17-41,01-39,53	
		COP.		1,76	
	Temperature range	Delivery water temperature	°CBS	25°C - 70°C	
		Outdoor air temperature	°CBS	-20°C - 40°C	
	Low water temperature 35°	Rank		A+	
		ηS	%	139	
	Medium water temperature 55°	Rank		A++	
		ηS	%	125	
Water pressure drop		kPa	12,6		
Volume of circulating water		m³/h	7,5 - 15,0		
Water pipe diameters	Return	mm	38,1 (Rc 1 1/2")		
	Delivery	mm	38,1 (Rc 1 1/2")		
Sound level ¹ at 1 m		dBA	59		
Sound level ¹ at 10 m		dBA	51		
External dimensions	HxWxD	mm	1710 x 1978 x 759		
Net weight		kg	526		
Ref. refill R407C ⁴ /CO ₂ Eq		kg/Tons	11/19.51		

Note:
¹ Nominal heating conditions: outdoor temperature of 7°C BS/6°C BU; water delivery temperature 45°C; water return temperature 40°C.
² Nominal heating conditions: outdoor temperature of 7°C BS/6°C BU; delivery water temperature 35°C; return water temperature 30°C.
³ Nominal heating conditions: outdoor temperature of 7°C BS/6°C BU; delivery water temperature 70°C.
⁴ GWP of HFC R407C equivalent to 1774 in line with regulation 517 / 2014.
 * The water circuit must be a closed circuit.
 * Install the unit in an environment where the outdoor wet bulb temperature does not exceed 32°C.



HWHP - CRHV

PACKAGED - WATER/WATER SYSTEM - Heating/Domestic Hot Water



WATER HEATING



DOMESTIC HOT WATER

The Ecodan® - Packaged HWHP (Hot Water Heat Pump) system consists of an outdoor monoblock air condensing unit which produces very high volumes of high-temperature hot water.

Packaged WtW heat pumps for hot water

With the latest Hot Water Heat Pump Packaged Water to Water CRHV system, Mitsubishi Electric has added to its range of heat pumps for hot water production and established the company as a leader in the manufacture of these systems. The CRHV packaged system is equipped with two compressors using R410A refrigerant, delivering a nominal capacity up to 60kW and drawing energy from the ground. It is the ideal solution for geothermal applications and applications using groundwater, river or lake water as a heat source to produce hot water for heating or domestic use up to 65°C. The Hot Water Heat Pump CRHV system offers class-beating innovation and efficiency.

Technology

SCOP
Over 4*

The new CRHV packaged system is also equipped with a flash-injection circuit designed for the VRF CITY MULTI ZUBADAN Y system (heat pump system for very cold climates). By using this advanced injection system and a highly efficient compressor, the CRHV packaged system can deliver

high-temperature hot water up to 65°C, and ensures fewer losses in terms of performance and capacity at very low outdoor temperatures.

* SCOP 4.33 - Outlet water/glycol temperature -3°C. Outlet water temperature 35°C.

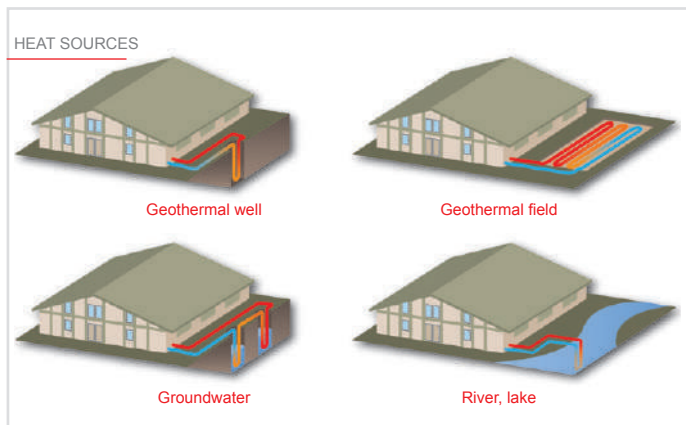
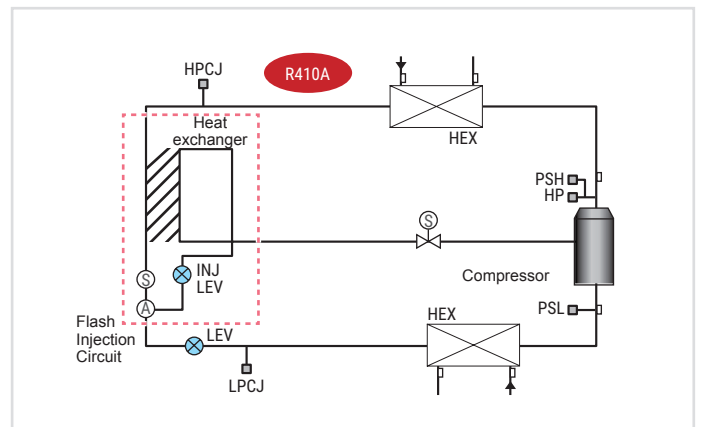

Upgrading existing systems

The latest CRHV packaged system can reuse existing geothermal probes or wells, adapting to their actual thermal capacity. The inverter-driven CRHV packaged system is capable of adjusting its thermal capacity to between 45kW and 60kW in relation to the actual amount of heat deliverable by the existing geothermal well.

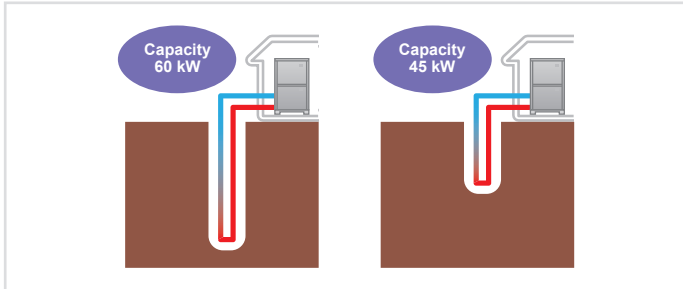

Operating temperatures

The new CRHV packaged system is capable of operating at incoming source water temperatures of between -8°C and 27°C with a counterflow configuration (the incoming source water temperature range can be extended up to 45°C using a parallel flow configuration). The water delivery temperature range is from 30°C to 65°C (in parallel flow configuration, the maximum water delivery temperature is 60°C at incoming water temperatures above 27°C). The CRHV packaged system is suited to indoor installation.

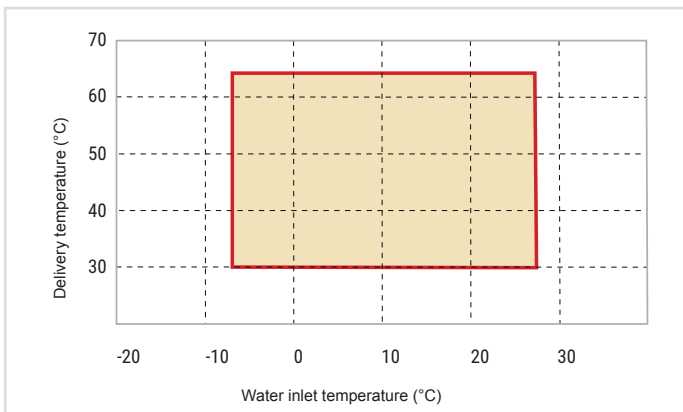

Finishing treatment

The module can also be ordered with a special protective finish on request, for installation in particularly harsh or corrosive environments.



Backup and rotation functions

Backup Function
Rotation Function

The CRHV packaged system is highly reliable thanks to its Backup function, which ensures that if one of the compressors in an individual system fails, the other will continue operating to avoid the inconvenience of the system shutting down completely. Obviously heat capacity is halved under these conditions.

Another key function for ensuring uniform operation and optimal compressor lifetime in compressors in CRHV packaged systems in multiple configurations is the Rotation function. This ensures that when an installation has two or more systems, the individual systems will operate in turn if thermal demand does not require simultaneous operation.

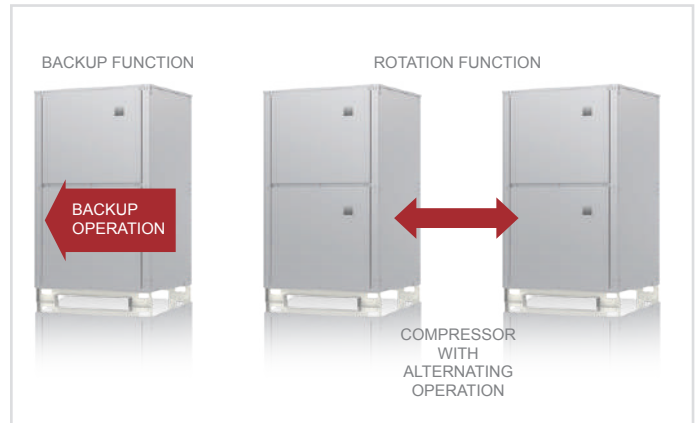

Cascade systems

When the demand for large volumes of hot water production is high, a flexible, modular thermal power installation can be created with up to 16 CRHV packaged systems, for a maximum output of up to 960 kW, with integrated cascade control.

This solution offers a high level of modularity thanks to the 2 DC scroll inverter compressors installed in an individual system, ensuring that thermal power is adjusted progressively and with extreme precision in relation to actual hot water demands. This optimises the operation of the entire installation, with only part of the CRHV packaged system operating under medium-load conditions during typical spring and autumn temperatures.

A malfunction in one or several CRHV packaged systems will not compromise the operation of the other systems in the installation, ensuring safety and continuous operation.



External remote control

Wide variety of external input/output

A wide choice of analogue and digital inputs and digital outputs available with the system's electronics enables remote control operation (via a BMS, timer or external contacts). The following are just some of the available input signals:

- Option of selecting operating mode and hot water production temperature setpoint, choosing Heating Mode or ECO Heating Mode. The latter mode is particularly advanced, as it uses the outdoor air compensation curve to automatically determine the water delivery setpoint.
- Option of selecting operating mode and hot water production temperature setpoint, choosing Domestic Hot Water Mode or Heating Mode. This makes it possible to configure two different water temperature setpoints, a higher value for domestic hot water production and a lower value for heating. This improves performance at partial loads, as DHW is only produced when required.
- Selecting Efficiency Mode (COP) or Capacity Mode for unit operation. This means system operation can be optimised in relation to demand, increasing power or performance depending on requirements.
- Selecting ON/OFF on the basis of the signals received from the flow regulator switch and the circulation pump, for increased protection of the hydronic circuit and satisfactory system operation.

The following are just some of the available output signals:

- A digital output can be enabled at a selectable minimum water temperature to start an alternative heat generator (boiler, solar panel etc.) to substitute the system if it is OFF.
- 3-way valve control in relation to hot water or heating demands.
- Pump control on circuit hot water side and heat source side (ON/OFF).

The result is maximum control flexibility, either locally using the dedicated PAR-W21MAA remote controller, or remotely using external contacts.

Compact dimensions

The unit has a compact footprint thanks to the latest, highly-efficient heat exchanger with low pressure losses. Installation footprint 0.73 m²*

*Dimensions of a unit excluding service space.

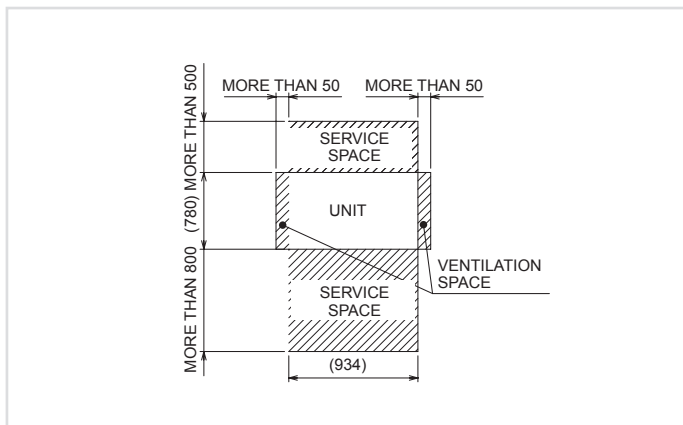

Control and monitoring functionality with centralized WEB Server controllers

With the M-Net data transmission bus, the CRHV packaged system can interface with the centralised **WEB Server 3D Touch** and **3D Blind Controllers** of the VRF CITY MULTI control system range. Depending on the application, the CRHV packaged system can therefore interface with a VRF CITY MULTI system to optimise operation when catering for hot water, heating and air conditioning demands, or to manage, monitor and supervise the system in a standalone configuration for applications solely requiring the production of large volumes of hot water. In both cases, the system can be controlled via a 10.4" backlit, colour touchscreen display on the 3DT controller, or via the Internet using the web pages for either centralised controller.



LAYOUT: ECODAN® PACKAGED HWHP CRHV (LOW AND HIGH TEMPERATURE HEATING + DHW)

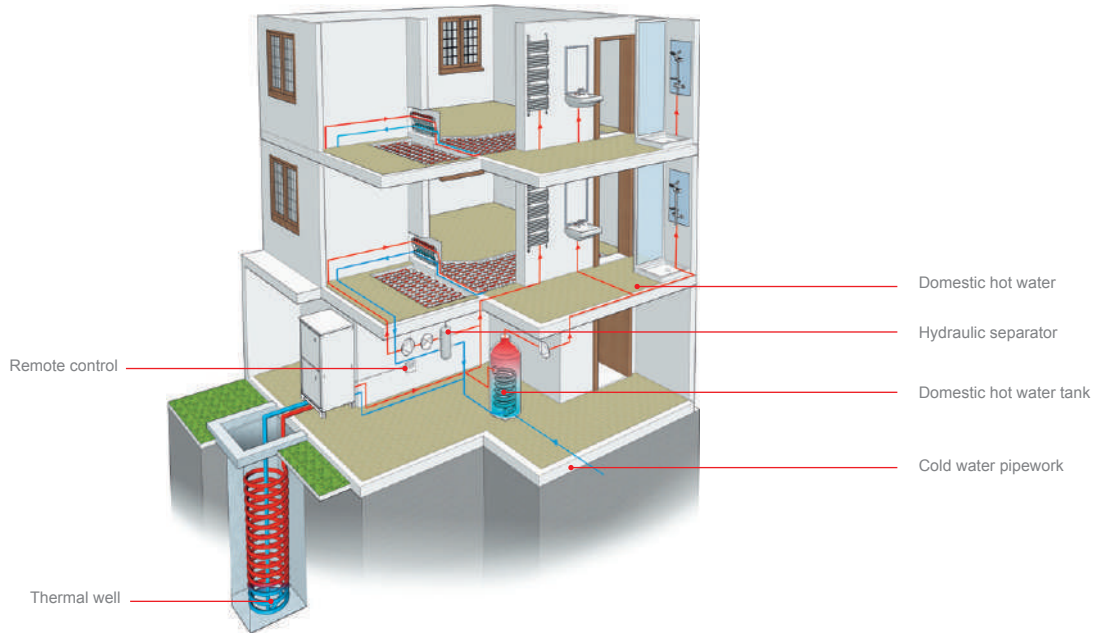

Technical specifications HEATING/COOLING/DOMESTIC HOT WATER

MODEL				CRHV-P600YA-HPB
Spring/Autumn heating	Power Supply	Voltage/Freq./Phases	V/Hz/no.	3 phases 380-400-415V; 50/60 Hz
	SCOP (power 60 kW) EN14825 Avg. clim. cond.	Heat source water/glycol 0°C/-3°C, Hot water 30°C/35°C		4,33
		Heat source water/glycol 0°C/-3°C, Hot water 47°C/55°C		2,89
	Nominal heating capacity ¹	Absorbed power	kW	60
		Absorbed current	A	24,0 - 22,8 - 22,0
		COP		4,23
		Flow rate of water in circuit	m³/h	10,3
		Flow rate of heat source water/glycol	m³/h	14,7
	Nominal heating capacity ²	Absorbed power	kW	45
		Absorbed current	A	17,2 / 16,4 / 15,8
		COP		4,41
		Flow rate of hot water in circuit	m³/h	7,7
		Flow rate of heat source water/glycol	m³/h	11,2
	Heat source liquid			Ethylene Glycol 35 WT
	Temperature range ⁴	Hot water side	°C	30 - 65
		Heat source water/glycol side	°C	-8 - 27
	Low water temperature 35°	Rank		A++
		ηS	%	153
	Medium water temperature 55°	Rank		A++
		ηS	%	127
Water pressure drop	Hot water side ³	kPa	14	
	Heat source water/glycol side ³		38	
Water pipe diameters	Return	mm	50,8 (Rc 2") threaded	
	Delivery	mm	50,8 (Rc 2") threaded	
Flow rate of water in circuit	Hot water side	m³/h	3,2 - 15,0	
	Heat source water/glycol side	m³/h	4,5 - 16,0	
Sound level at 1 m		dBA	50	
External dimensions HxWxD	HxWxD	mm	1561 x 934 x 780	
Net weight		kg	395	
Ref. refill R410A/CO ₂ Eq		kg/Tons	9/18.79	

Note:
¹ Nominal heating conditions: hot water delivery temperature 35°C; water/glycol outlet temperature -3°C; hot water return temperature 30°C; water/glycol inlet temperature 0°C.
² Includes the power absorbed by the pump in accordance with EN14511
³ Nominal heating conditions: hot water delivery temperature 35°C; water/glycol outlet temperature -3°C; hot water return temperature 30°C; water/glycol inlet temperature 0°C. Power 60 kW, hot water flow rate 10.3 m³; water/glycol flow rate 14.7 m³
⁴ GWP of HFC R410A equivalent to 2088 in line with regulation 517 / 2014.

Ventilation

All fresh air (AFA)

PEFY-P VMHS-E-F Outdoor fresh air intake unit (afa) 238

Lossnay enthalpy heat recovery (LGH)







LGH-RVS - Ducted sensible heat recovery unit 240

LGH-RVX (T) Lossnay - Heat recovery ventilation unit 244

Outdoor air treatment indoor units (GUF)

GUF-RD(H)4 Monoblock indoor unit with fresh air intake fan 250



TYPE	MODEL NAME	MODEL
All fresh air (AFA)	PEFY-P125VMHS-E-F PEFY-P200VMHS-E-F PEFY-P250VMHS-E-F	
Lossnay Enthalpy heat recovery (LGH)	LGH-RVS-E	
	LGH-50RVX-E LGH-65RVX-E LGH-80RVX-E LGH-100RVX-E	
	LGH-150RVX-E LGH-200RVX-E	
	LGH-150RVXT-E LGH-200RVXT-E LGH-250RVXT-E	
Outdoor air treatment indoor units (GUF)	GUF-50RD(H)4 GUF-100RD(H)4	

Air flow (mc/h)							
	500	600	800	1000	1500	2000	2500
				•	•	•	
	•		•	•			
	•	•	•	•			
					•	•	
					•	•	•
	•			•			

PEFY-P VMHS-E-F

OUTDOOR FRESH AIR INTAKE UNIT (AFA)



Ideal for...

...feeding temperature-controlled fresh outdoor air into building. The ideal solution for offices, large stores and restaurants.

Enables intake of outside air

The indoor purified air delivery unit may be installed anywhere. The purified air delivery unit may be used to feed fresh, purified outdoor air into any building, in any place and at any time.

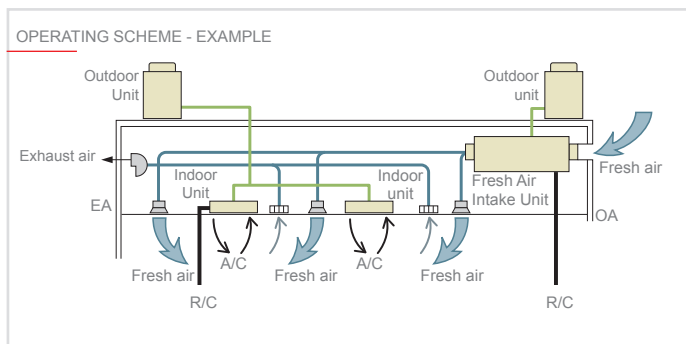
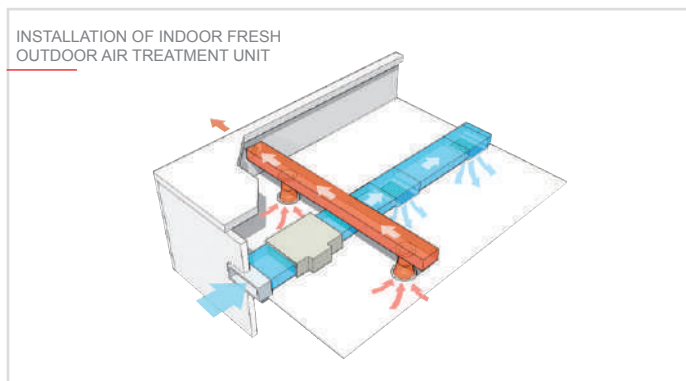

Controllable outlet air temperature

With new PEFY-P VMHS-E-F is possible to operate **Supply Air** temperature control.

OPERATION MODE	TEMPERATURE RANGE SETTABLE
COOL mode	14°C - 30°C
HEAT mode	17°C - 28°C
AUTO mode (single set point)	17°C - 28°C
FAN	Not settable

* In some cases the temperature of the air introduced into the ambient may be subject to fluctuations due to the conditions of the external air and to the operating conditions of the system.

Equipped with new DC fan motor

Fan motor has been changed to higher efficiency DC motor. Power source has been changed from three-phase power supply to **single-phase** power supply for all sizes.

Maximum connectable indoor units capacity to outdoor unit

Max. 110% of outdoor unit capacity (100% in case of heating below -5°C).

Flexible air-flow setting

4 levels of external static pressure to choose. External static pressure can be set also by remote controller (PAR-33/40MAA, PAR-U02MEDA and PAR-CT01MA).

MODEL	P125	P200	P250
External Static Pressure (Pa)	<100>-<150>-200-<250>		

* The factory setting of external static pressure is shown without chevrons "< >".

Two types of air-flow modes are available, each of which has three air-flow rates to choose from:

- Normal Airflow rate
- High Airflow rate

Air-flow rates are accessible from the remote controller (PAR-33/40MAA, PAR-U02MEDA and PAR-CT01MA).

Mode	Normal-airflow rate	High-airflow rate
Air-flow rate	Low-Medium-High	Low-Medium-High

Drain pump (optional)

Greater design flexibility made possible by the increased head height (700 mm max).

UNIT MODEL	DRAIN PUMP MODEL
PEFY-P125 VMHS-E-F	PAC-DRP10DP-E2
PEFY-P200 VMHS-E-F	PAC-KE06DM-F
PEFY-P250 VMHS-E-F	PAC-KE06DM-F

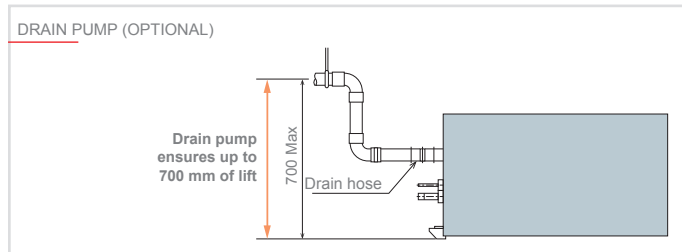

Specifications

MODEL		PEFY-P125VMHS-E-F	PEFY-P200VMHS-E-F	PEFY-P250VMHS-E-F				
Power source	V/phase/Hz	1 phase, 220-230-240V 50/60 Hz						
Cooling capacity ¹	kW	14.0	22.4	28.0				
	Btu/h	47,800	76,400	95,500				
Heating capacity ²	kW	8.9	13.9	17.4				
	Btu/h	30,400	47,400	59,400				
Temperature range	Cooling	17°C D.B./15.5°C W.B. + 43°C D.B./35°C W.B. Thermo-off (FAN-mode) automatically starts if the outdoor temperature is lower than 17°C D.B.						
	Heating	+10°C D.B. + 20°C D.B. Thermo-off (FAN-mode) automatically starts if the outdoor temperature is higher than 20°C D.B.						
Power input ³	Cooling kW	0.220	0.260	0.350				
	Heating kW	0.230	0.270	0.360				
Current input ³	Cooling A	1.43	1.66	2.16				
	Heating A	1.52	1.85	2.38				
External finish		Galvanized						
External dimension HxWxD	mm	380x1195x900	470x1250x1120	470x1250x1120				
Net weight	kg	49	78	81				
Heat exchanger		Cross fin (aluminum fin and copper tube)						
Motor	Type	DC Motor						
	Output kW	0.244	0.375	0.375				
Refrigerant piping diameter	Gas (brazed) mm	15.88	19.05	22.22				
	Liquid (brazed) mm	9.52	9.52	9.52				
Field drain pipe size	mm	O.D. 32	O.D. 32	O.D. 32				
Fan	Type x Quantity	Sirocco fan x 1	Sirocco fan x 2	Sirocco fan x 2				
	External static press. ⁴ Pa	<100> - <150> - 200 - <250>						
	Air flow rate ⁵		Normal Airflow rate mode	High Airflow	Normal Airflow	High Airflow	Normal Airflow	High Airflow
		m ³ /min	14.0 - 15.5 - 18.0	15.5 - 18.0 - 20.0	22.5 - 25.0 - 28.0	25.0 - 28.0 - 32.0	28.0 - 31.0 - 35.0	31.0 - 35.0 - 40.0
L/s		233 - 258 - 300	258 - 300 - 333	375 - 417 - 467	417 - 467 - 533	467 - 517 - 583	517 - 583 - 667	
cfm	494 - 547 - 636	547 - 636 - 706	794 - 883 - 898	883 - 989 - 1,130	989 - 1,095 - 1,236	1,095 - 1,236 - 1,412		
Sound pressure level ² (Low-Mid-High)		Normal Airflow	High Airflow	Normal Airflow	High Airflow	Normal Airflow	High Airflow	
	dB(A)	34-37-41	36-40-42	35-38-41	36-39-42	38-40-44	38-41-45	

¹ Cooling capacity indicates the maximum value at operation under the following condition. Cooling: Indoor 33°CDB/28°CWB, Outdoor 33°CDB. The set temperature of the remote controller is 18°C.

² Heating capacity indicates the maximum value at operation under the following condition. Heating: Indoor 0°CDB/-2.9°CWB, Outdoor 0°CDB/-2.9°CWB. The set temperature of the remote controller is 25°C.

³ The value are measured at the factory setting of airflow mode and external static pressure.

⁴ The factory setting of airflow mode and external static pressure mode is shown without < >. Refer to "Fan characteristics curves", according to the external static pressure, in DATA BOOK for the usable range of air flow rate.

⁵ If the airflow rate is over the usable range, dew drop can be caused from the air outlet and the air flow rate is changed automatically because of the output down by the fan motor control. If the air flow rate is less than the usable range, condensation from the unit surface can be caused.

The combination of fresh air intake type indoor units with other types of indoor units to handle internal thermal load which may cause the conflict of operation mode. It is not recommended when fresh air intake type indoor unit is connected to the Y or WY series.

Depending on the air conditioning load, outside temperature, and due to the activation of protection functions, the desired preset temperature may not always be achieved and the discharge temperature may swing. Note that untreated outside air may be delivered directly into the room upon the activation of protection functions.

Fresh air intake type indoor units cannot be connected to PUMY and cannot be connected to an outdoor unit together with PWFY series.

The maximum connectable indoor units to 1 outdoor unit are 110% (100% in case of heating below -5°C).

When fresh air intake type indoor units connect to an outdoor unit together with other types of indoor unit, the total capacity of fresh air intake type indoor units needs to be 30% or less of the connected outdoor unit capacity.

The AUTO mode on the local remote controller is available only when fresh air intake type indoor unit is connected to the R2 or WR2 series of outdoor unit.

The system changeover function is available only when all the connected indoor units are fresh air intake type indoor units.

The fan temporarily stops during defrost.

The cooling and heating capacities are the maximum capacities that were obtained by operating in the above air conditions and with a refrigerant pipe of about 7.5 m and a level difference of 0 m.

The actual capacity characteristics vary with the combination of indoor and outdoor units. See the technical information in DATA BOOK for the details.

Thermo off (Fan) operation automatically starts either when temperature is lower than 17°CDB in cooling mode or when the temperature exceeds 20°CDB in heating mode.

Dry mode is not available.

When this unit is used as sole A/C system, be careful about the dew in air outlet grilles in cooling mode.

Un-conditioned outdoor air such as humid air or cold air blows to the indoor during thermo off operation. Please be careful when positioning indoor unit air outlet grilles, ie take the necessary precautions for cold air, and also insulate rooms for dew condensation prevention as required.

Air filter must be installed in the air intake side. The filter should be attached where easy maintenance is possible in case of usage of field supply filters.

LGH-RVS NEW

DUCTED SENSIBLE HEAT RECOVERY UNIT



SIZES	
LGH-50RVS	500 mc/h @ 150 Pa
LGH-80RVS	800 mc/h @ 170 Pa
LGH-1000RVS	1000 mc/h @ 190 Pa

Standard filter (provided with the unit)	Optional filter
G3 (Coarse 50%)	F8 (ePM1 65%)

Ideal for...

Ducted indoor unit equipped with fresh air intake fan, exhaust fan, filtering system, Lossnay sensitive heat recovery system and bypass damper.

Sensible heat recovery unit

The new Lossnay LGH-RVS sensible heat recovery unit caters to different needs thanks to its features and accessories. Ease of installation, ultra-quiet operation and recovery efficiency are the three key features of this model.

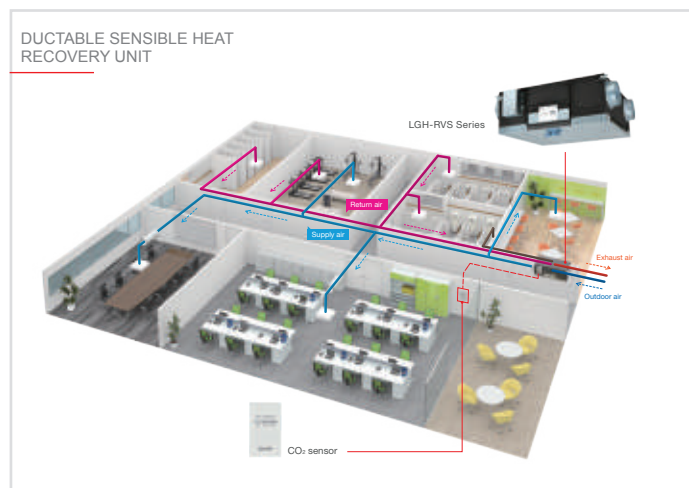

CO₂ sensor (optional)

A CO₂ sensor connected directly to the unit means that the airflow rate can be optimised according to the level of carbon dioxide detected in the room, improving heat exchange efficiency and contributing to energy saving.

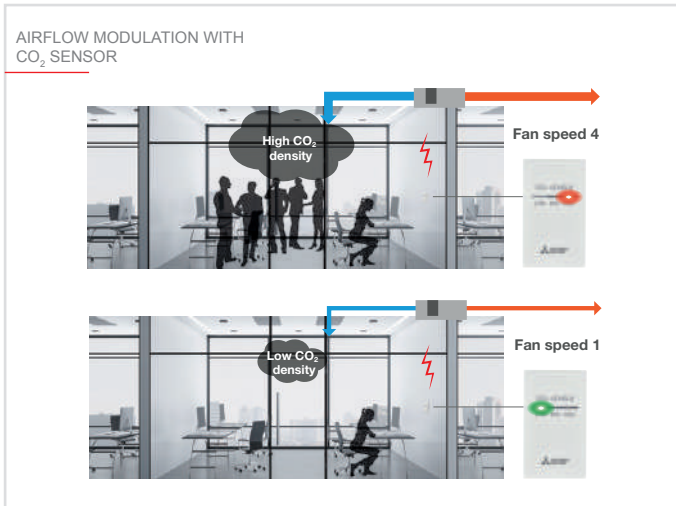

OPTIONAL CO₂ SENSOR



PZ-70CSW-E (sensor for wall-mounted installation). The CO₂ levels are indicated by the LEDs on the sensor.



PZ-70CSB-E (sensor built into the unit)

Easy installation

Lighter weight

Being lightweight is one of the most important factors in installation. The lightweight frame of the LGH-RVS series can provide a huge advantage in terms of installation cost and safety.

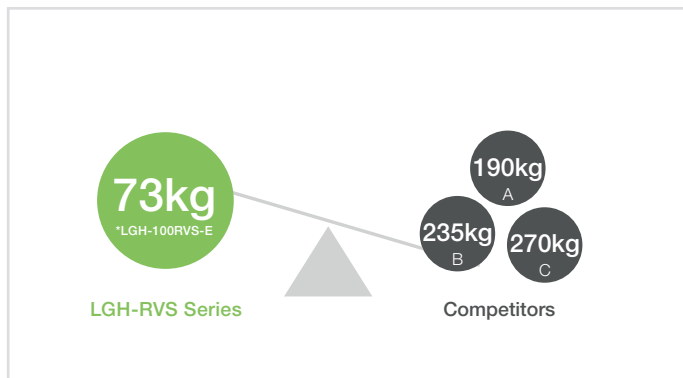

Silent and efficient operation

The new LGH-RVS recovery unit has extremely low noise emissions thanks to the special sirocco fan produced by Mitsubishi Electric coupled with a high-efficiency motor.



Single condensate drain

The LGH-RVS unit is equipped with a special condensate drain that allows the connection of a single condensate evacuation pipe. Connection to the pipeline is made easy thanks to the rotating connection system. Furthermore, thanks to the special design of the new drainage system, there is no need for an external siphon.

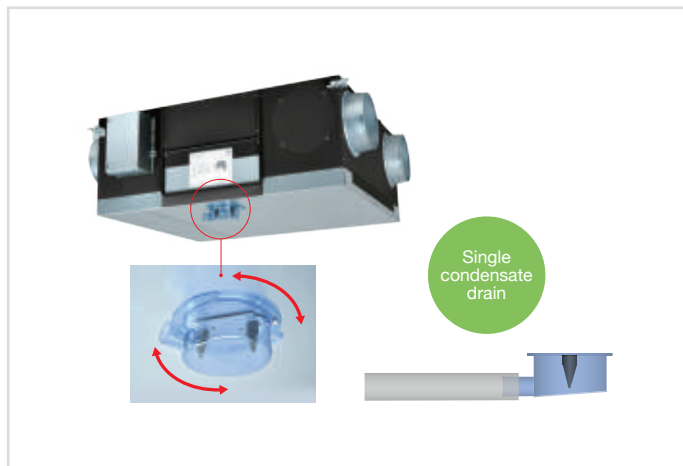

Dedicated PZ-62DR-EB wired controller

The new PZ-62DR-EB controller can be used to control all the functions of the LGH-RVS unit.

If the PZ-70CSW-E (optional) or PZ-70CSB-E (optional) CO₂ sensor is used, the carbon dioxide concentration in the room can be displayed on the control unit's display.

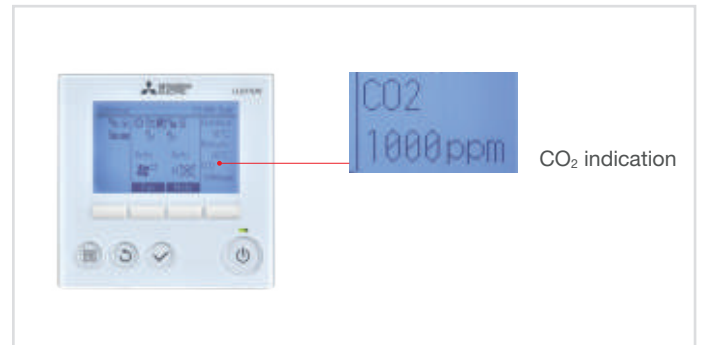

Customisable filtration level

The new LGH-RVS is fitted with G3 filters (Coarse 50%) as standard. F8 filters can be used for higher performance filtration

Filter Model	Class. EN779:2012	Class. ISO16890:2016	No. filters per set	Compatible VL model	Filter position	Maintenance	Filter life*
PZ-S50RF-E	G3	Coarse 55%	2	LGH-50RVS-E	RA, OA	Clean the air filter once a year	Approx. 5 years with periodic cleaning/maintenance
PZ-S80RF-E				LGH-80RVS-E			
PZ-S100RF-E				LGH-100RVS-E			
PZ-S50RFH-E	F8	ePM1 65%	2	LGH-50RVS-E	SA	Disposable filter. No cleaning/washing	Approximately one year or when blocked
PZ-S80RFH-E				LGH-80RVS-E			
PZ-S100RFH-E				LGH-100RVS-E			

Airflow modulation

The fan inverter motor, designed and manufactured directly by Mitsubishi Electric, guarantees maximum performance with minimum energy consumption and allows **inlet and outlet ventilation speed modulation from 25% to 100%** (+/- 5% increments/decrements).

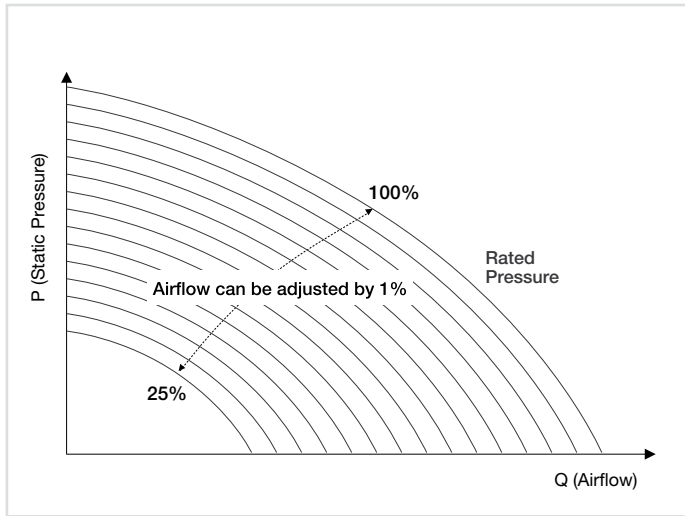

MELCloud connection (optional)

The unit can be controlled and monitored remotely via the **MeiCloud** platform. This requires the installation of the optional **MAC-587IF-E** interface card.



Technical data LGH-50RVS-E

MODEL		LGH-50RVS-E			
Electrical power supply	V/Phase/Hz	220-240/MONOPHASE /50			
Fan speed		100%	75%	50%	25%
Input power	W	190	110	60	25
Air volume	m³/h	500	375	250	125
	L/s	139	104	69	35
External static pressure	Pa	150	84	38	9
Sensible heat exchange efficiency	%	87	89	91	93
Standard filter	EN 779 (ISO 16890)	G3 (Coarse 35%)			
Noise	dB(A)	33	27	22	18
Weight	kg	55			
Dimensions	HxLxD	mm 529 x 974 x 946			
Guaranteed field of operation (continuous operation)*	Outdoor temp.	°C	0 ~ +40		
	Max. indoor temp.	%	40		
	Max. indoor RU	°C	90		
	Max. indoor AH	%	0.0139		

DIAGRAM LGH-50RVS-E

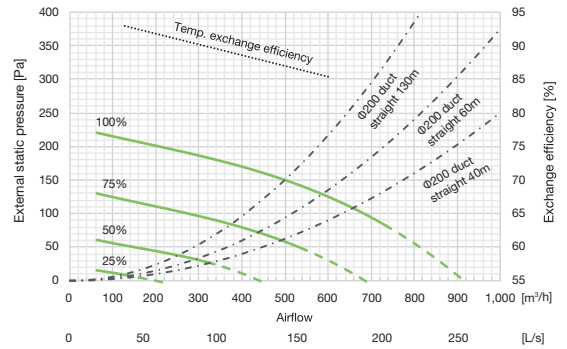

Technical data LGH-80RVS-E

MODEL		LGH-80RVS-E			
Electrical power supply	V/Phase/Hz	220-240/MONOPHASE /50			
Fan speed		100%	75%	50%	25%
Input power	W	325	175	85	32
Air volume	m³/h	800	600	400	200
	L/s	222	167	111	56
External static pressure	Pa	170	96	43	11
Sensible heat exchange efficiency	%	82	84	86	90
Standard filter	EN 779 (ISO 16890)	G3 (Coarse 35%)			
Noise	dB(A)	36	30	25	18
Weight	kg	63			
Dimensions	HxLxD	mm 529 x 1185 x 997			
Guaranteed field of operation (continuous operation)*	Outdoor temp.	°C	0 ~ +40		
	Max. indoor temp.	%	40		
	Max. indoor RU	°C	90		
	Max. indoor AH	%	0.0139		

DIAGRAM LGH-80RVS-E

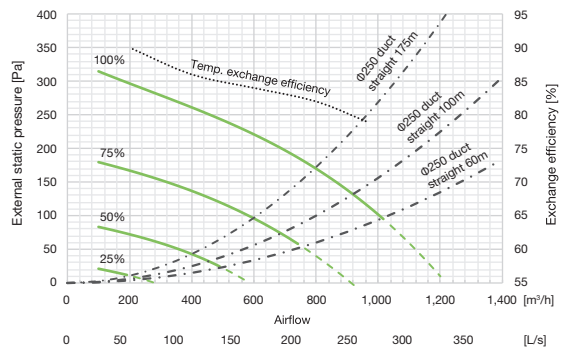

Technical data LGH-100RVS-E

MODEL		LGH-100RVS-E			
Electrical power supply	V/Phase/Hz	220-240/MONOPHASE /50			
Fan speed		100%	75%	50%	25%
Input power	W	445	225	100	35
Air volume	m³/h	1000	750	500	250
	L/s	278	208	139	69
External static pressure	Pa	190	107	48	12
Sensible heat exchange efficiency	%	82	84	86	90
Standard filter	EN 779 (ISO 16890)	G3 (Coarse 35%)			
Noise	dB(A)	37	32	24	18
Weight	kg	73			
Dimensions	HxLxD	mm 529 x 1185 x 1224			
Guaranteed field of operation (continuous operation)*	Outdoor temp.	°C	0 ~ +40		
	Max. indoor temp.	%	40		
	Max. indoor RU	°C	90		
	Max. indoor AH	%	0.0139		

DIAGRAM LGH-100RVS-E

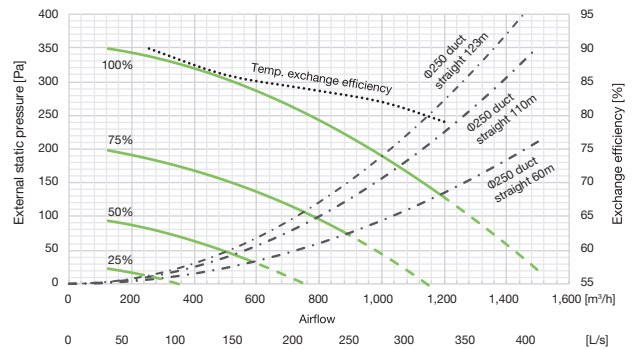

LGH-RVX(T)

LOSSNAY - Heat recovery ventilation unit

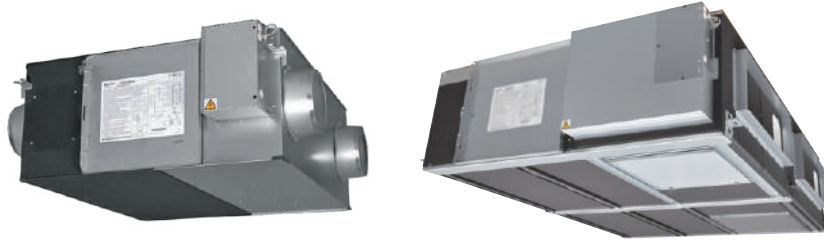

Lossnay – Heat recovery ventilation units

The importance of adequate air exchange

Air quality is a primary parameter for comfort. Poor air quality in the office or at home has been proven to have a significantly detrimental influence on productivity and on the healthiness of the environment, and contribute to fatigue. This is due to increasing concentrations of CO₂ caused by inadequate air exchange. To live comfortably, **every individual needs 400l of fresh air per hour**. Ensuring **adequate ventilation** in residential and commercial buildings is necessary to **offer a healthy, comfortable environment for all occupants**.

A dry environment offers the ideal conditions for the proliferation of **bacteria and viruses**, and the survival rate of these micro-organisms drops rapidly at relative humidity levels above 50%. **Excessively humid environments**, on the other hand, encourage the proliferation of **mould and mites**. Precise humidity control is therefore an important factor in maintaining ideal, healthy conditions.

The importance of correctly controlled humidity

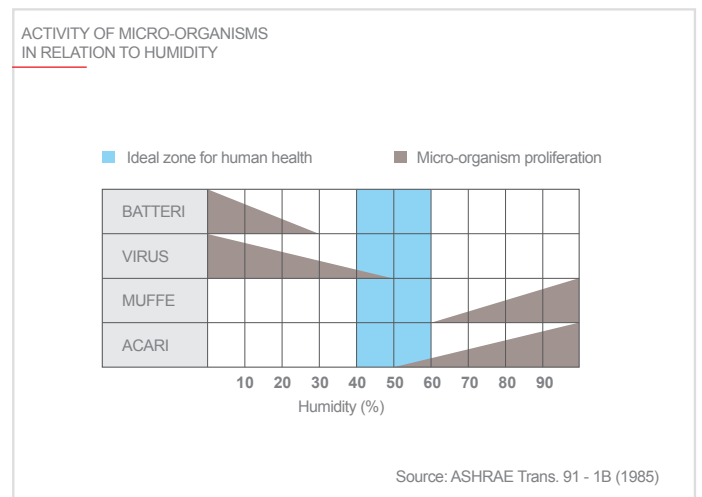
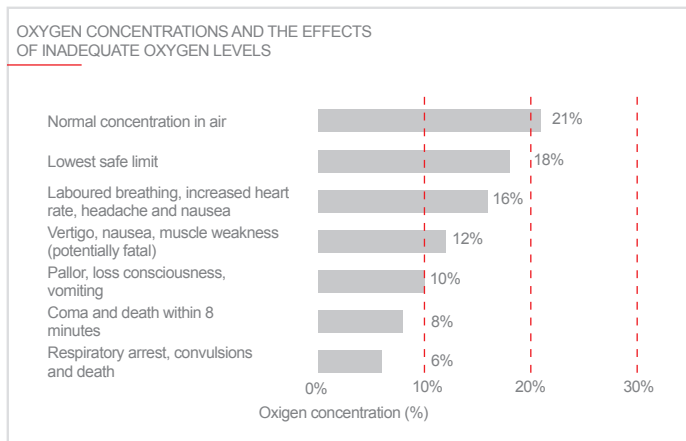

Simple construction

As shown in the figure, the Lossnay exchanger consists of a structure in special treated paper allowing two different air flows to cross one another and exchange thermal energy. Partitions separating the inlet and outlet channels prevent incoming fresh air from ever mixing with outgoing air.

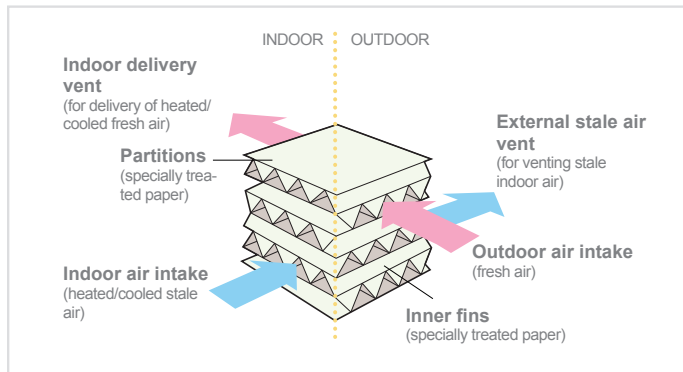

Operating principle

The Lossnay exchanger performs a highly effective total exchange action for both temperature (sensible heat) and humidity (latent heat) – the system uses moisture permeable partitions in specially treated paper to allow stale air to be vented externally and fresh outdoor air to be fed to the indoor space with absolutely no mixing between the two air flows.

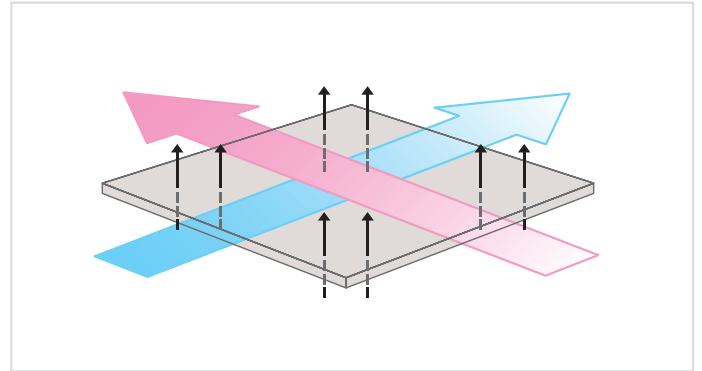

Energy recovery

Comfort and energy savings

With universally recognised efficiency, Lossnay heat exchanger ventilation units use energy recovery to offer significant energy savings.

A conventional ventilation system vents treated indoor air into the outdoor environment and replaces this air with outdoor air, causing the room to lose heat in winter and heat up in summer. This loss of heated/cooled air means that energy must be expended to restore comfortable temperature conditions in the indoor space. The result of this is notably higher air conditioning costs. To solve this problem while still ensuring the necessary air exchange, Mitsubishi Electric offers a range of thermal energy recovery ventilation systems, which minimise air conditioning costs.

All Lossnay units are equipped with class "G3" air filter as standard (Coarse 35% based on ISO 16890). LGH-RVX models may also be equipped with a class "M6" high efficiency filter (ePM10 75% based on ISO 16890).

Comfortable air exchange action, in either cold or hot outdoor conditions

Summer - Difference in temperature between new fresh air and air already in room of only 1.7°C.

- Incoming fresh air is brought to the same conditions as the cooled (and dehumidified) air in the room.

Winter - 4 kg/h humidity recovered

- Incoming fresh air is brought to the same conditions as the warmed (and humidified) air in the room.

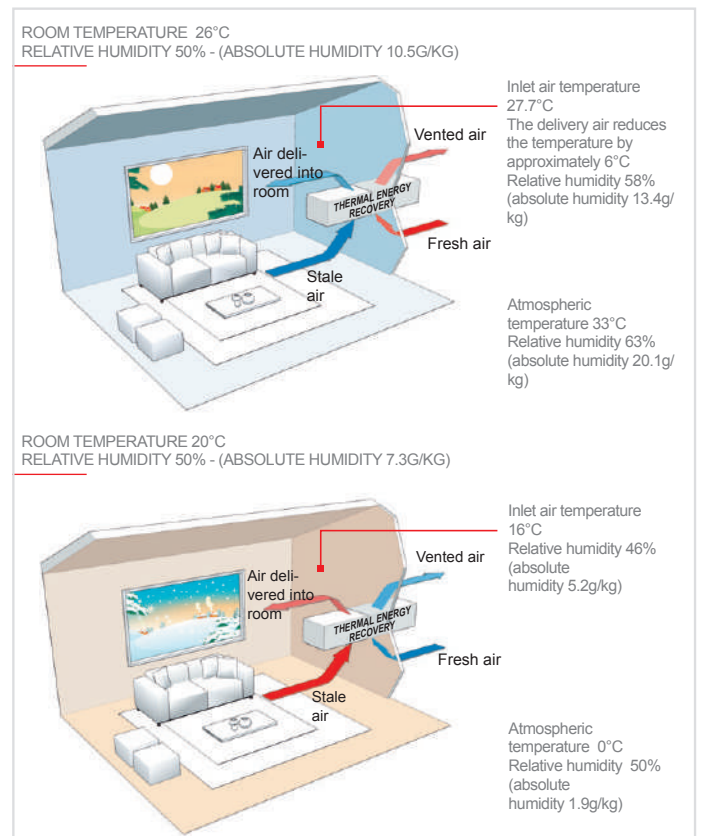
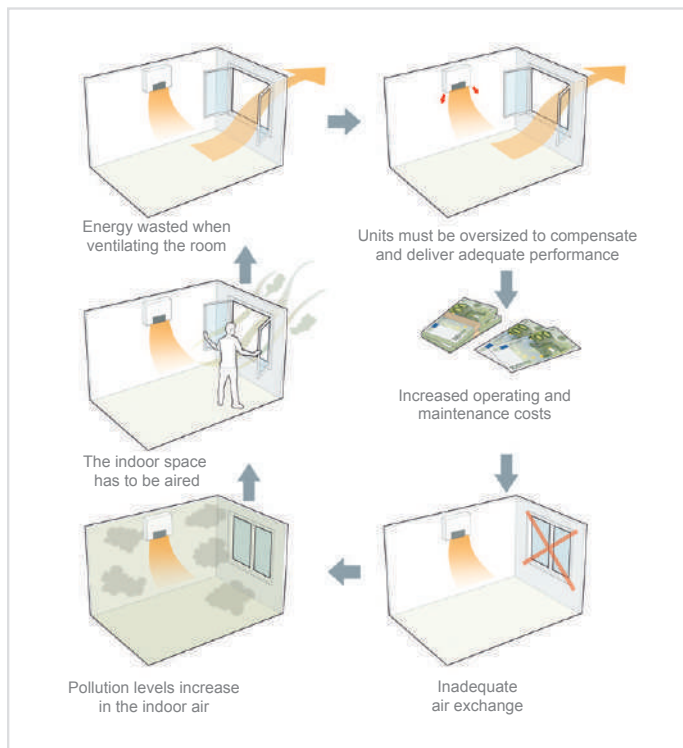

Low noise

Precise control over the flow of treated air significantly reduces the sound pressure values of the LOSSNAY unit by up to 18 dB(A). All LGH-RVX units ensure ideal acoustic comfort, including for residential applications, libraries, offices etc.



Lossnay for energy savings

New DC FAN Motor

The new DC motor used throughout the new LGH-RVX series offers a number of advantages:

- **Very low electric power consumption**, especially at low speeds
- Lower noise emissions
- Increased flexibility and fine air flow adjustment from remote control.

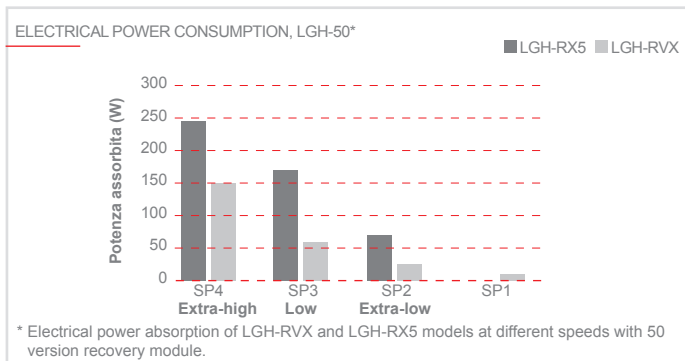

Bypass shutter

The LGH-RVX series is equipped with a bypass shutter:

When the shutter is open, fresh air is fed to the interior space with no heat recovery, passing through the filter only.

The bypass shutter may be activated manually from the remote control, or automatically in specific thermal conditions (Free-Cooling).

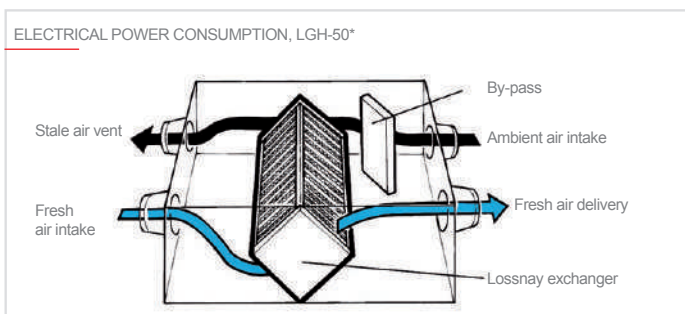

New PZ-62DR-E dedicated remote control

The new wired remote control unit specifically for LGH-RVX heat recovery units boasts a fresh new look and new features.

- Possibility of managing a group of up to 15 units
- Simple and intuitive
- Backlit LCD screen
- Internal weekly timer
- Custom ventilation strategies for mode switching (Auto/recovery/bypass)
- Night purge function for active night-time ventilation in summer.



Easy installation

High air volumes and low height.

Three new models with important innovations have supplemented the LGH enthalpic recuperators line.

The RVXT models treat high volumes of air (up to 250m³/h) and are extremely low in height (only 500mm), a feature that makes them exceptionally flexible during installation, especially where the height of the false ceiling does not allow the use of RVX models.

The RVXT models are also equipped with an enthalpy exchange package in treated paper and are fitted with "G3" filters as standard (Coarse 35% based on ISO 16890).

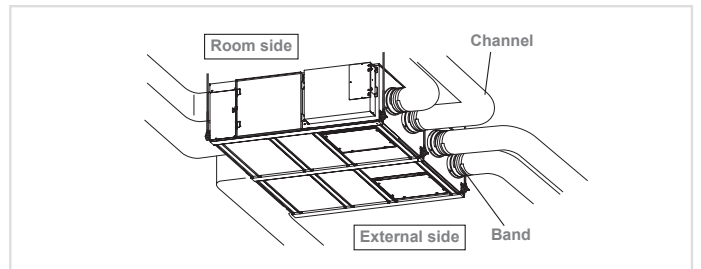

Technical specifications

MODEL		LGH-50RVX-E					
Power supply	V/Phase/Hz	220-240 / 1-phase /50					
Speed		SP4	SP3	SP2	SP1		
Current	A	1.15	0.59	0.26-0.27	0.13		
Power input	W	165-173	78-81	32-35	12-14		
Air volume	m³/h	500	375	250	125		
	L/s	138.9	104.2	69.4	34.7		
External static pressure	mmH ₂ O	12.24	6.93	3.06	0.82		
	Pa	120	68	30	8		
Temp. heat exch. Efficiency	%	78.0	81.0	83.5	87.0		
Total heat exch. Efficiency	Cooling	%	66.5	68.0	72.5	82.0	
	Heating	%	69.0	71.0	75.0	82.5	
Sound pressure level	dB(A)	34-35	28-29	19-20	18		
Duct qty x diameter	mm	4 x 200	4 x 200	4 x 200	4 x 200		
Wheight	kg	33	33	33	33		
Dimensions	HxLxD	mm	331x1016 x888	331x1016 x888	331x1016 x888	331x1016 x888	
	Outdoor temp.	°C	-10 ~ +40	-10 ~ +40	-10 ~ +40	-10 ~ +40	
Operating field*	Max outdoor RH	%	80	80	80	80	
	Max indoor temp	°C	40	40	40	40	
	Max indoor RH	%	80	80	80	80	
	Max indoor RH	%	80	80	80	80	

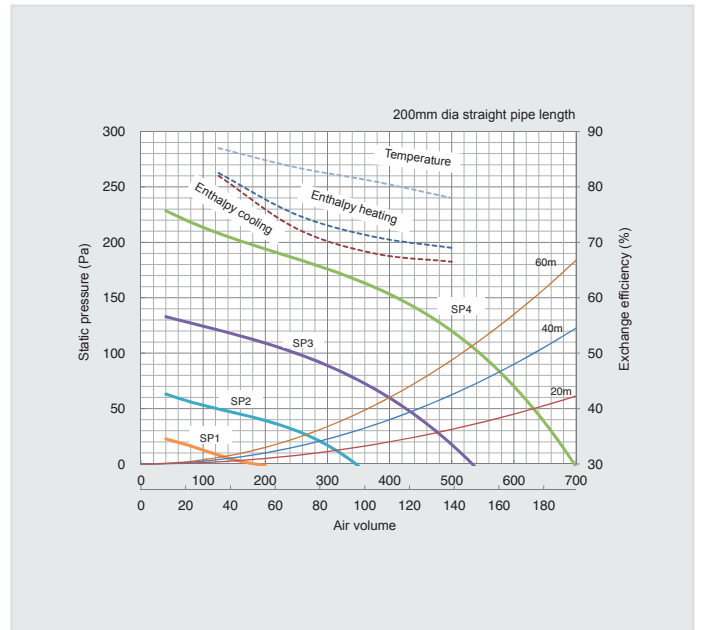

Technical specifications

MODEL		LGH-65RVX-E					
Power supply	V/Phase/Hz	220-240 / 1-phase /50					
Speed		SP4	SP3	SP2	SP1		
Current	A	65-1.72	0.90-0.86	0.39-0.38	0.15-0.16		
Power input	W	252-262	131	49-47	15-17		
Air volume	m³/h	650	488	325	163		
	L/s	180.6	135.4	90.3	45.1		
External static pressure	mmH ₂ O	12.24	6.93	3.06	0.82		
	Pa	120	68	30	8		
Temp. heat exch. Efficiency	%	77.0	81.0	84.0	86.0		
Total heat exch. Efficiency	Cooling	%	66.0	69.5	74.0	81.0	
	Heating	%	68.5	71.0	76.0	82.0	
Sound pressure level	dB(A)	34.5-35.5	29	22	18		
Duct qty x diameter	mm	4 x 200	4 x 200	4 x 200	4 x 200		
Wheight	kg	38	38	38	38		
Dimensions	HxLxD	mm	404x954 x908	404x954 x908	404x954 x908	404x954 x908	
	Outdoor temp.	°C	-10 ~ +40	-10 ~ +40	-10 ~ +40	-10 ~ +40	
Operating field*	Max outdoor RH	%	80	80	80	80	
	Max indoor temp	°C	40	40	40	40	
	Max indoor RH	%	80	80	80	80	
	Max indoor RH	%	80	80	80	80	

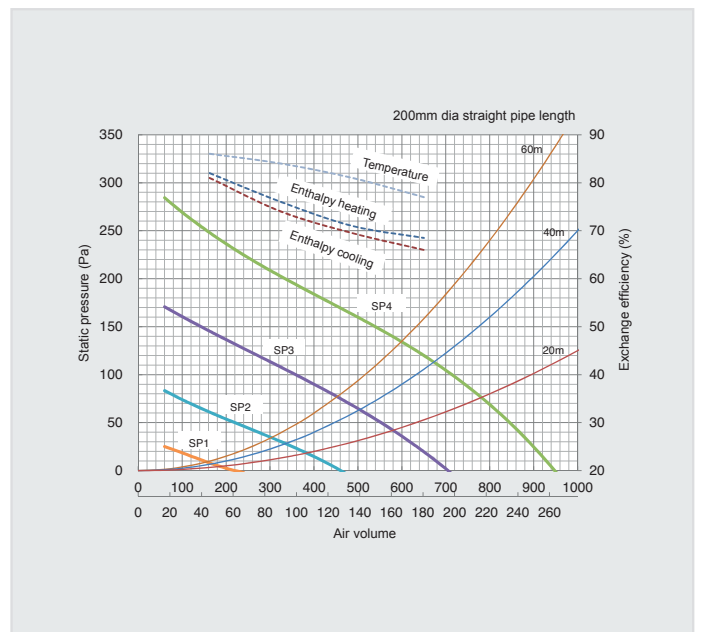

Technical specifications

MODEL		LGH-80RVX-E					
Power supply	V/Phase/Hz	220-240 / 1-phase /50					
Speed		SP4	SP3	SP2	SP1		
Current	A	1.82-1.97	0.83-0.86	0.36-0.40	0.15-0.16		
Power input	W	335-340	151	60-64	18-20		
Air volume	m³/h	800	600	400	200		
	L/s	222.2	166.7	111.1	55.6		
External static pressure	mmH ₂ O	15.30	8.67	3.82	1.02		
	Pa	150	85	37.5	10		
Temp. heat exch. Efficiency	%	79.0	82.5	84.0	85.0		
Total heat exch. Efficiency	Cooling	%	70.0	72.5	78.0	81.0	
	Heating	%	71.0	73.5	78.0	81.0	
Sound pressure level	dB(A)	34.5-36.0	30.0	23	18		
Duct qty x diameter	mm	4 x 250	4 x 250	4 x 250	4 x 250		
Wheight	kg	48	48	48	48		
Dimensions	HxLxD	mm	404x1004 x1144	404x1004 x1144	404x1004 x1144	404x1004 x1144	
	Outdoor temp.	°C	-10 ~ +40	-10 ~ +40	-10 ~ +40	-10 ~ +40	
Operating field*	Max outdoor RH	%	80	80	80	80	
	Max indoor temp	°C	40	40	40	40	
	Max indoor RH	%	80	80	80	80	
	Max indoor RH	%	80	80	80	80	

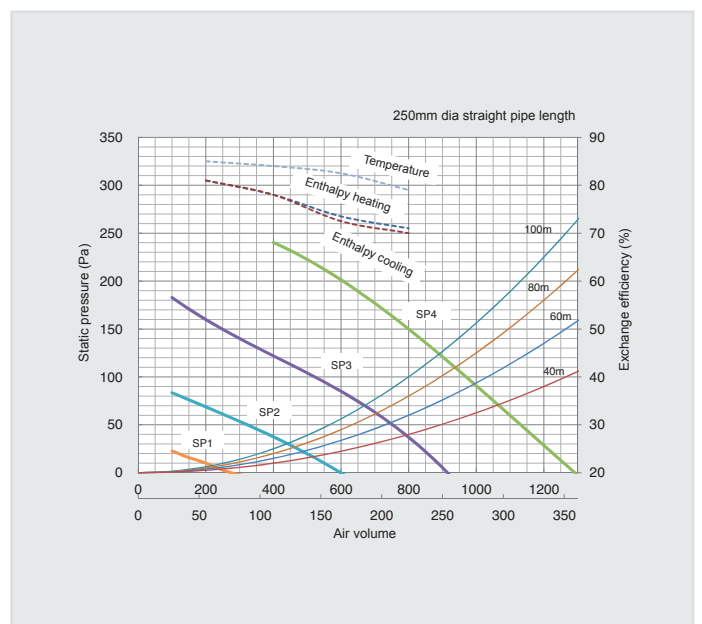

* In case of temperature < -10°C fan will work discontinuously. Lossnay controlled heat generator is recommended in this condition.

Technical specifications

MODEL		LGH-100RVX-E				
Power supply	V/Phase/Hz	220-240 / 1-phase /50				
Speed		SP4	SP3	SP2	SP1	
Current	A	2.50	1.20	0.50-0.51	0.17-0.19	
Power input	W	420	200	75	21	
Air volume	m³/h	1000	750	500	250	
	L/s	277.8	208.3	138.9	69.4	
External static pressure	mmH ₂ O	17.34	9.75	4.33	1.08	
	Pa	170	95.6	42.5	10.6	
Temp. heat exch. Efficiency	%	80.0	83.0	86.5	89.5	
Total heat exch. Efficiency	Cooling	%	71.0	73.0	77.0	85.5
	Heating	%	72.5	74.0	78.0	87.0
Sound pressure level	dB(A)	37-38	31-32	23-24	18	
Duct qty x diameter	mm	4 x 250	4 x 250	4 x 250	4 x 250	
Wheight	kg	54	54	54	54	
Dimensions	HxLxD	mm	404x1231 x1144	404x1231 x1144	404x1231 x1144	404x1231 x1144
	Operating field*	Outdoor temp. °C	-10 ~ +40	-10 ~ +40	-10 ~ +40	-10 ~ +40
Operating field*	Max outdoor RH	%	80	80	80	80
	Max indoor temp	°C	40	40	40	40
	Max indoor RH	%	80	80	80	80

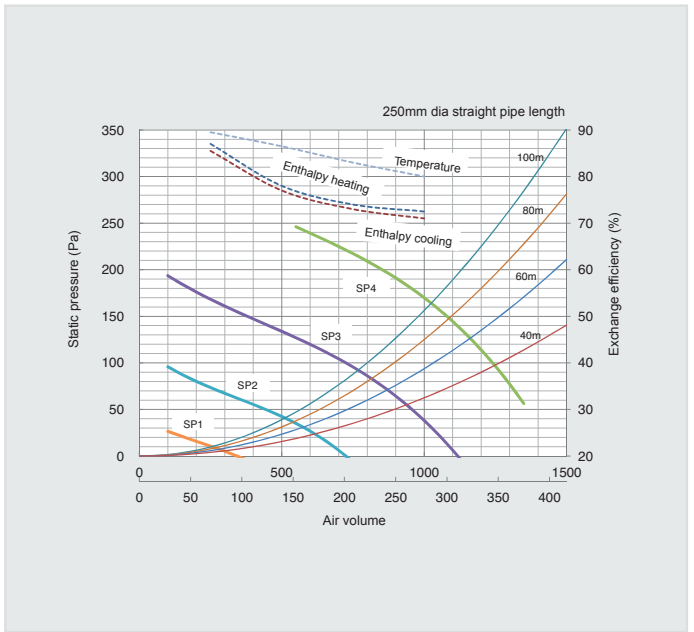

Technical specifications

MODEL		LGH-150RVX-E				
Power supply	V/Phase/Hz	220-240 / 1-phase /50				
Speed		SP4	SP3	SP2	SP1	
Current	A	3.71-3.85	1.75-1.78	0.70-0.78	0.29-0.30	
Power input	W	670-698	311	123-124	38-44	
Air volume	m³/h	1500	1125	750	375	
	L/s	416.7	312.5	208.3	104.2	
External static pressure	mmH ₂ O	17.85	10.03	4.47	1.11	
	Pa	175	98.4	43.8	10.9	
Temp. heat exch. Efficiency	%	80.0	82.5	84.0	85.0	
Total heat exch. Efficiency	Cooling	%	70.5	72.5	78.0	81.0
	Heating	%	72.0	73.5	78.0	81.0
Sound pressure level	dB(A)	39.0-40.5	32-33	24-26	18	
Duct qty x diameter	mm	4 x 250 / 2 x 4 x 250 / 2 x 4 x 250 / 2 x 4 x 250 / 2 x (270x700)				
Wheight	kg	98	98	98	98	
Dimensions	HxLxD	mm	808x1004x1144	808x1004x1144	808x1004x1144	808x1004x1144
	Operating field*	Outdoor temp. °C	-10 ~ +40	-10 ~ +40	-10 ~ +40	-10 ~ +40
Operating field*	Max outdoor RH	%	80	80	80	80
	Max indoor temp	°C	40	40	40	40
	Max indoor RH	%	80	80	80	80

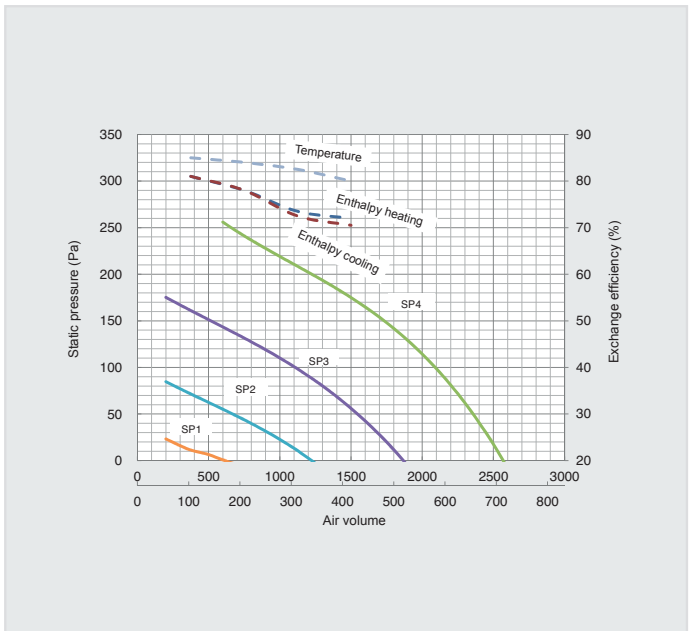

Technical specifications

MODEL		LGH-200RVX-E				
Power supply	V/Phase/Hz	220-240 / 1-phase /50				
Speed		SP4	SP3	SP2	SP1	
Current	A	4.88-4.54	2.20-2.06	0.88-0.87	0.33-0.35	
Power input	W	850-853	400-372	153-150	42-49	
Air volume	m³/h	2000	1500	1000	500	
	L/s	555.6	416.7	277.8	138.9	
External static pressure	mmH ₂ O	15.30	8.61	3.82	0.97	
	Pa	150	84.4	37.5	9.5	
Temp. heat exch. Efficiency	%	80.0	83.0	86.5	89.5	
Total heat exch. Efficiency	Cooling	%	71.0	73.0	77.0	85.5
	Heating	%	72.5	74.0	78.0	87.0
Sound pressure level	dB(A)	40-41	40-41	40-41	40-41	
Duct qty x diameter	mm	4 x 250 / 2 x 4 x 250 / 2 x 4 x 250 / 2 x 4 x 250 / 2 x (270x700)				
Wheight	kg	110	110	110	110	
Dimensions	HxLxD	mm	808x1231 x1144	808x1231 x1144	808x1231 x1144	808x1231 x1144
	Operating field*	Outdoor temp. °C	-10 ~ +40	-10 ~ +40	-10 ~ +40	-10 ~ +40
Operating field*	Max outdoor RH	%	80	80	80	80
	Max indoor temp	°C	40	40	40	40
	Max indoor RH	%	80	80	80	80

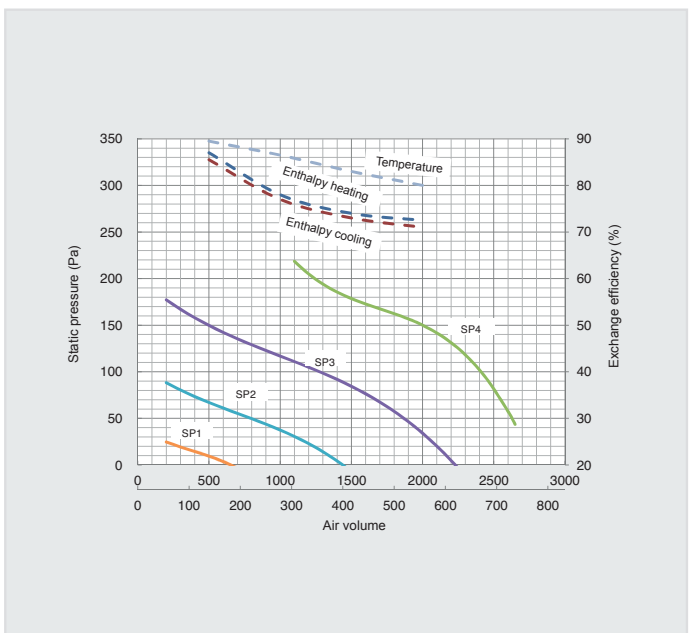

* In case of temperature < -10°C fan will work discontinuously. Lossnay controlled heat generator is recommended in this condition.

Technical specifications			MODEL			
			LGH-150RVXT-E			
Power supply	V/Phase/Hz	220-240 / 1-phase /50				
Speed		SP4	SP3	SP2	SP1	
Current	A	4.30 - 3.40	2.40 - 1.80	1.10 - 0.77	0.36 - 0.31	
Power input	W	792 - 625	421 - 334	176 - 134	48 - 37	
Air volume	m³/h	1500	1125	750	375	
	L/s	417	313	208	104	
External static pressure	mmH ₂ O	175	98	44	11	
	Pa	100	56	25	6	
Temp. heat exch. Efficiency	%	80.0	80.5	81.0	81.5	
Total heat exch. Efficiency	Cooling	%	69.0	70.0	72.0	74.0
	Heating	%	70.0	71.0	73.0	75.0
Sound pressure level	dB(A)	39.5	35.5	29.5	22.0	
Duct qty x diameter	mm	4 x 250 / 2 x 4 x 250 / 2 x 4 x 250 / 2 x 4 x 250 / 2 x (250x750) (250x750) (250x750) (250x750)				
Wheight	kg	156	156	156	156	
Dimensions	HxLxD	mm	500 x 1980 x 1500	500 x 1980 x 1500	500 x 1980 x 1500	500 x 1980 x 1500
	Operating field*	Outdoor temp. °C	-10 ~ +40	-10 ~ +40	-10 ~ +40	-10 ~ +40
		Max outdoor RH %	80	80	80	80
		Max indoor temp °C	40	40	40	40
		Max indoor RH %	80	80	80	80

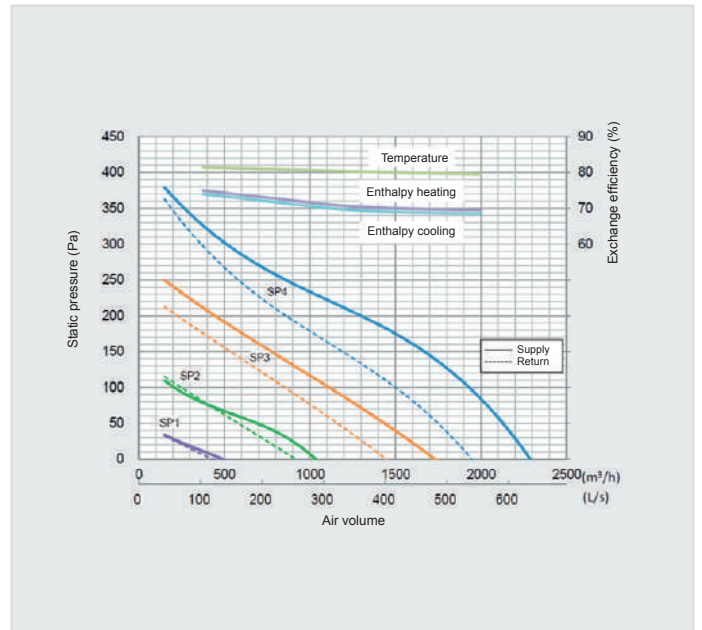

Technical specifications			MODEL			
			LGH-200RVXT-E			
Power supply	V/Phase/Hz	220-240 / 1-phase /50				
Speed		SP4	SP3	SP2	SP1	
Current	A	5.40 - 5.00	2.70 - 2.20	1.10 - 0.85	0.39 - 0.34	
Power input	W	1000 - 916	494 - 407	197 - 150	56 - 45	
Air volume	m³/h	2000	1500	1000	500	
	L/s	556	417	278	139	
External static pressure	mmH ₂ O	175	98	44	11	
	Pa	100	56	25	6	
Temp. heat exch. Efficiency	%	80.0	81.0	82.5	84.0	
Total heat exch. Efficiency	Cooling	%	70.0	71.0	74.5	80.5
	Heating	%	72.5	73.5	77.0	83.0
Sound pressure level	dB(A)	39.5	35.5	28.0	22.0	
Duct qty x diameter	mm	4 x 250 / 2 x 4 x 250 / 2 x 4 x 250 / 2 x 4 x 250 / 2 x (250x750) (250x750) (250x750) (250x750)				
Wheight	kg	159	159	159	159	
Dimensions	HxLxD	mm	500 x 1980 x 1500	500 x 1980 x 1500	500 x 1980 x 1500	500 x 1980 x 1500
	Operating field*	Outdoor temp. °C	-10 ~ +40	-10 ~ +40	-10 ~ +40	-10 ~ +40
		Max outdoor RH %	80	80	80	80
		Max indoor temp °C	40	40	40	40
		Max indoor RH %	80	80	80	80

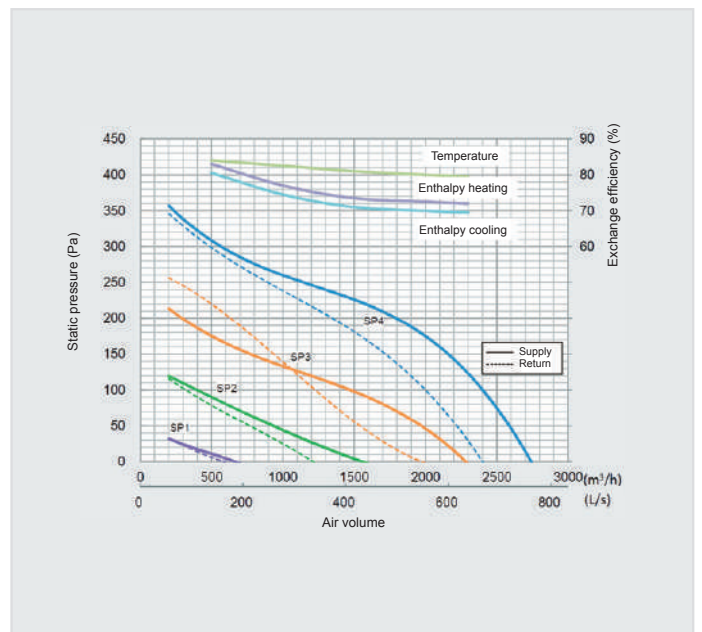

Technical specifications			MODEL			
			LGH-250RVXT-E			
Power supply	V/Phase/Hz	220-240 / 1-phase /50				
Speed		SP4	SP3	SP2	SP1	
Current	A	7.60 - 6.90	3.60 - 3.10	1.40 - 1.30	0.57 - 0.49	
Power input	W	1446 - 1298	687 - 587	244 - 212	82 - 69	
Air volume	m³/h	2500	1875	1250	625	
	L/s	694	521	347	174	
External static pressure	mmH ₂ O	175	98	44	11	
	Pa	100	56	25	6	
Temp. heat exch. Efficiency	%	77.0	79.0	80.5	82.5	
Total heat exch. Efficiency	Cooling	%	65.5	69.0	71.5	76.5
	Heating	%	68.0	71.5	74.0	79.0
Sound pressure level	dB(A)	43.0	39.0	32.0	24.0	
Duct qty x diameter	mm	4 x 250 / 2 x 4 x 250 / 2 x 4 x 250 / 2 x 4 x 250 / 2 x (250x750) (250x750) (250x750) (250x750)				
Wheight	kg	198	198	198	198	
Dimensions	HxLxD	mm	500 x 1980 x 1500	500 x 1980 x 1500	500 x 1980 x 1500	500 x 1980 x 1500
	Operating field*	Outdoor temp. °C	-10 ~ +40	-10 ~ +40	-10 ~ +40	-10 ~ +40
		Max outdoor RH %	80	80	80	80
		Max indoor temp °C	40	40	40	40
		Max indoor RH %	80	80	80	80

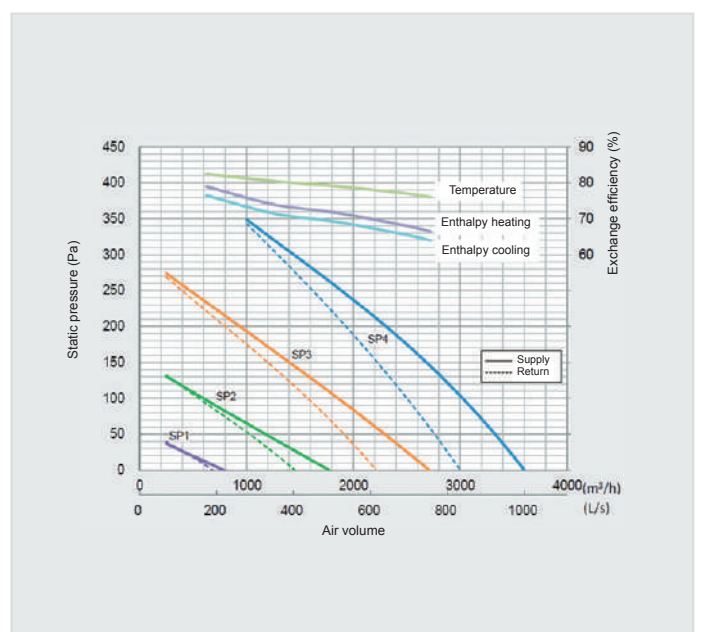

* In case of temperature < -10°C fan will work discontinuously. Lossnay controlled heat generator is recommended in this condition.

GUF-RD(H)4

MONOBLOCK INDOOR UNIT WITH FRESH AIR INTAKE FAN

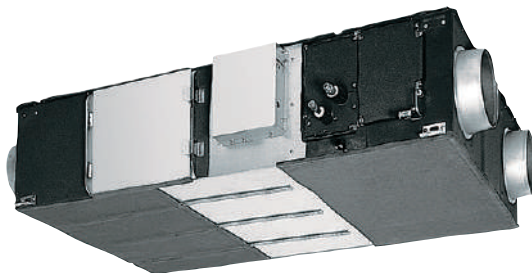

Monoblock indoor unit with fresh air intake fan, stale air exhaust fan, filtration system, Lossnay total heat recovery module, bypass shutter, permeable film humidifier (only for RDH4 version) and direct expansion coil.

Serie RD(H)4

GUF-50RD(H)4

Cooling capacity 5.57 (DX coil: 3.63, Lossnay core: 1.94) kW Heating capacity 6.18 (DX coil: 6.21, Lossnay core: 2.04) kW 500 m³/h 220-240V 50Hz single-phase

GUF-100RD(H)4

Cooling capacity 11.44 (DX coil: 3.63, Lossnay core: 3.85) kW Heating capacity 12.56 (DX coil: 8.30, Lossnay core: 4.26) kW 500 m³/h 220-240V 50Hz single-phase



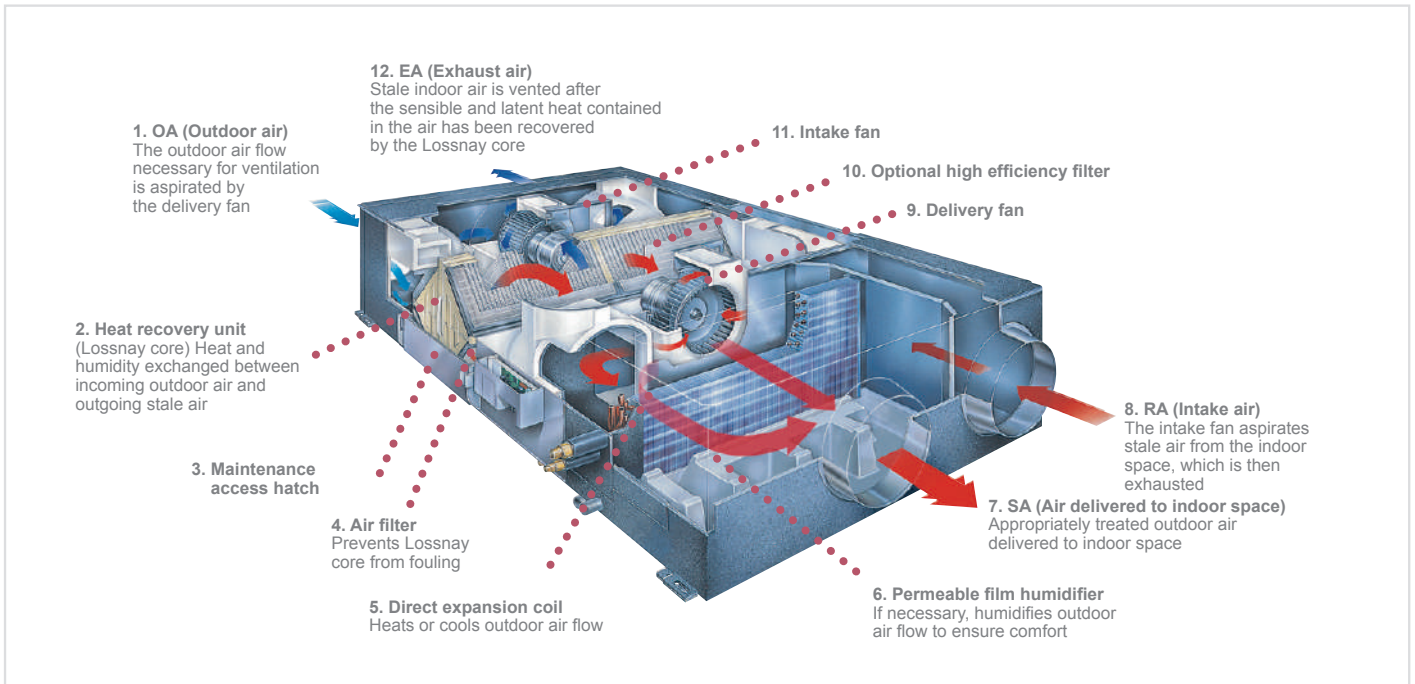

Lossnay technology

The Lossnay total heat recovery module has a cross-flow plate fin structure and heat transfer diaphragms in special treated paper. The excellent thermal transfer properties and permeability to moisture of this special paper ensure the highly efficient exchange of both sensible and latent heat between the two air flows passing through the recovery core. The result is a ventilation system with outstanding characteristics ensuring extremely high levels of comfort and wellbeing in the environment treated, which can also cut operating costs substantially.

The incoming fresh air and outgoing stale air cannot mix within the core. The diaphragm pores, which were already microscopic in previous generations, have been further reduced in size to reduce the possibility of the passage of waterborne soluble gases such as ammonia and hydrogen. To increase heat and moisture exchange, a special treatment is applied to the paper used for the diaphragms. These improvements have increased moisture permeability while reducing permeability to harmful gases, resulting in an overall increase in recovery efficiency and a more effective barrier action against the transfer of these gases.

IN GENERAL
 GUF – For optimum indoor air quality
 $GUF = (Lossnay) + (heating \& cooling)$

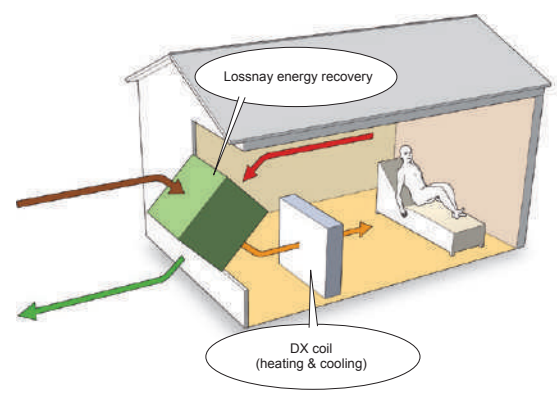
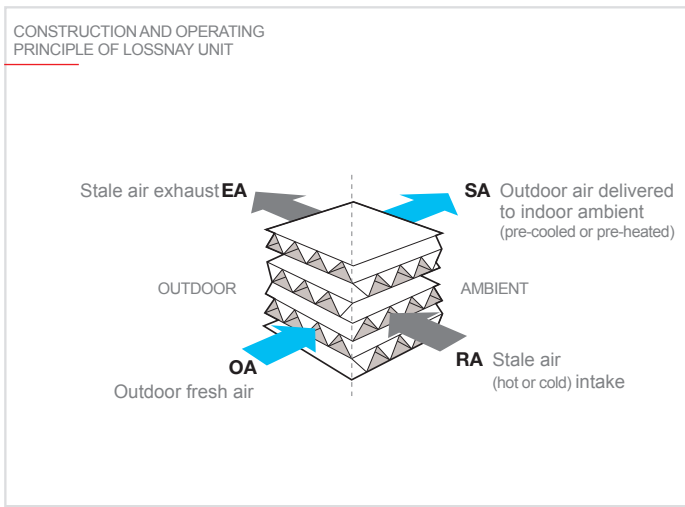

IMAGE OF GUF MODEL



Heat exchanger

A direct expansion coil incorporated in the unit makes it possible to cover approximately 25% of the load of the system with the GUF unit. This also means that the terminal units installed in the indoor space can be smaller. Moreover, as the GUF unit covers the entire thermal load attributable to ventilation, this means that this load and the ambient load can be managed completely separately, simplifying the design process of the installation. The treated air heats the humidifier as it passes through it, further increasing humidification efficiency.

Total comfort

Maintaining the correct humidity levels in an indoor space ensures the ideal conditions for comfort and prevents the unpleasant side-effects typical of an environment with insufficient humidity such as dry eyes and throat.

The evaporation surface area is approximately 8.5 times larger than in a comparably sized natural evaporation humidifier, while performance is 6 times greater.

Humidification - RDH4 version

The innovative permeable film humidification system, which uses a natural evaporation process, is a particularly intelligent solution.

The efficiency with which the air is humidified has been significantly increased by reducing the resistance of the material used. A three-layer film ensures that only the necessary moisture is transferred to the air without any limescale dust release – a problem of certain conventional humidifiers.

Maintaining the correct humidity levels in an indoor space ensures the ideal conditions for comfort and prevents the unpleasant side-effects typical of an environment with insufficient humidity such as dry eyes and throat.

The evaporation surface area is approximately 8.5 times larger than in a comparably sized natural evaporation humidifier, while performance is 6 times greater.

Note: Use a demineraliser if residual total salt levels exceed 100 mg/l.

Increased efficiency of humidification process - RDH4 version

Optimised air flows within the unit together with a water injection system have significantly increased the efficiency of the humidification process. The system also controls the humidity in the outgoing stale air to effectively improve the air quality of the outdoor environment as well. This solution prevents limescale and silica dust from being carried in the air, so purer, less dusty air is vented into the outdoor environment.

Automatic free cooling

When the air conditioning is operating in cooling mode and the outdoor temperature is lower than the indoor ambient temperature (as normally occurs at night-time in summer), the GUF indoor unit recognises this condition and automatically bypasses the recovery core. The cooler outdoor air fed into the indoor space contributes to reducing the cooling demand sustained by the system.

Dust suppression

An optional high efficiency filter may be used for up to 3,000 hours while maintaining a filtration efficiency (evaluated with colorimetric testing) of over 65%. The filter may also be fitted in the GUF unit after initial installation and takes up no additional precious space.

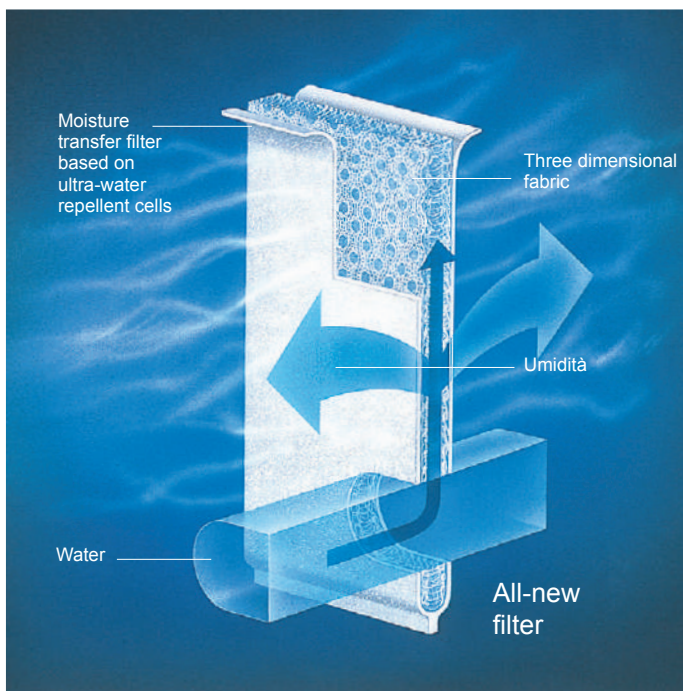

Automatic regulation

GUF ventilation and recovery units may be integrated into a Melans control and regulation system for Mitsubishi Electric air conditioner installations, as they use the same bus used for connecting indoor units.

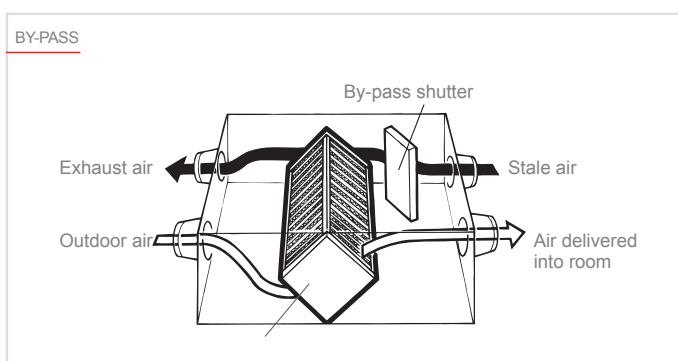

Advantages

- Reduced energy consumption
- Reduced thermal power necessary to treat outdoor air, equating to lower rated power
- Healthier environment
- Quieter operation (noise baffles in inlet and outlet)
- Free Cooling function using exclusively external air
- Humidification with film permeable to water vapour only
- Total air treatment (neutral air returned to outdoor environment)
- Custom temperature and humidity control
- Compact dimensions
- Installable in double ceilings with limited vertical space.

Flexible installation

The positions of air duct connections may be changed as needed to cater for different installation requirements.

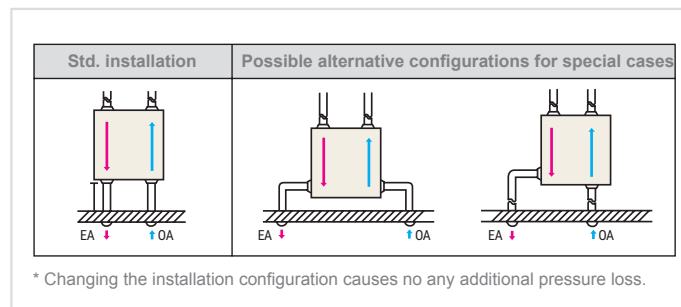

Technical specifications

MODEL		GUF-50RDH4		GUF-100RDH4		GUF-50RD4		GUF-100RD4		
Power supply		1-phase 220-240V 50Hz								
Communication system		In serie tramite rete M-NET: Mitsubishi Electric Air Conditioners Network System								
Lossnay	Mode	Air to Air Total heat recovery system								
	Material	Partition, Cross-flow structure, Special preserved paper-plate.								
Cooling capacity*1		kW	5,57	(1,94)	11,4	(4,12)	5,57	(1,94)	11,44	(4,12)
	Power input	W	235-265		480-505		235-265		480-505	
	Current	A	1,15		2,2		1,15		2,2	
Heating capacity*1		kW	6,21	(2,04)	12,56	(4,26)	6,21	(2,04)	12,56	(4,26)
	Power input	W	235-265		480-505		235-265		480-505	
	Current	A	1,15		2,2		1,15		2,2	
Temperature heat recovery efficiency		%	77,5/80		79,5/81,5		77,5/80		79,5/81,5	
Total heat recovery efficiency*2	Heating	%	68/71		71/74		68/71		71/74	
	Cooling	%	65/67		69/71		65/67		69/71	
Capacity index			P32		P63		P32		P63	
Humidifier capacity		kg/h	2,7		5,4		-		-	
Fan	Type x qty		SA: Centrifugal fan (Sirocco FAN) x 1 - EA: Centrifugal fan (Sirocco FAN) x 1							
	Static pressure	Pa	125		135		140		140	
		mmH ₂	12,7		13,8		14,3		14,3	
	Motor		Totally enclosed capacitor permanent split-phase induction motor, 4 poles, 2 units							
	Flow rate (High speed)	m ³ /h	500		1000		500		1000	
L/s		139		278		139		278		
SPL (Low-High)		dB(A)	33,5-34,5		38-39		33,5-34,5		38-39	
Ref. Piping diameter	Liquid	mm(in.)	Ø6,35(Ø1/4)		Ø9,52(Ø3/8)		Ø6,35(Ø1/4)		Ø9,52(Ø3/8)	
	Gas	mm(in.)	Ø12,7(Ø1/2)		Ø15,88(Ø5/8)		Ø12,7(Ø1/2)		Ø15,88(Ø5/8)	

*1 () value from Lossnay heat recovery.

*2 High/Low speed values.

Control Systems

Remote control

PAC-YT52CRA Design Remote Control	258
PAR-41MAA Deluxe Remote Control NEW	259
PAR-CT01MA Prisma Remote Control	260
PAR-U02MEDA Advanced Remote Control	262

Wireless remote control

PAR-FL32MA Wireless Remote Control	264
PAR-SL101A-E Wireless Remote Control	265

Remote control

PZ-62DR-EB Lossnay Remote Control NEW	266
PAR-W21MAA / PAR W31MAA Ecodan Remote Control	268

Centralized control

AT-50B System Centralized Control	269
AE-200E 3D Touch Controller / Web Server Centralized Control	270
EW-50 3D Blind Controller / Web Server Centralized Control	272
CHARGE "Charge" System for Centralized Web Server Controls	273



Interface for hotel simplified application

MELCOTEL Integrated Solution for Hotels 274

Remote monitoring and control system

3D TABLET CONTROLLER Wi-Fi Remote Management System 280

MELCLOUD CITY MULTI

Cloud-based remote management and supervisor system 282

REMOTE MONITORING INTERFACE

Cloud Remote Management System 284

External signal integration

ADVANCED HVAC CONTROLLER External Signal Integration 286

LMAP04 B.M.S. Interface for Lonworks® Networks 287

XML B.M.S. Interface for Ethernet Networks 288

ME-AC-MBS-100 B.M.S. Interface for Modbus® Networks 289

ME-AC-KNX-100 B.M.S. Interface for Knx® Networks 290

BACnet® PIN CODE B.M.S. Interface for Bacnet® Networks 291



Control Systems



PAC-YT52CRA

DESIGN REMOTE CONTROL



PAR-41MAA NEW

DELUXE REMOTE CONTROL



PAR-CT01MA

PRISMA REMOTE CONTROL



PAR-U02MEDA

ADVANCED REMOTE CONTROL



PAR-FL32MA

PAR-SL101A-E

WIRELESS REMOTE CONTROL



PZ-62DR-EB NEW

LOSSNAY REMOTE CONTROL



PAR-W21MAA

PAR-W31MAA

ECODAN REMOTE CONTROL



AT-50B

SYSTEM CENTRALIZED CONTROL



AE-200E

3D TOUCH Controller
WEB SERVER CENTRALIZED
CONTROL



EW-50

3D BLIND Controller
WEB SERVER CENTRALIZED
CONTROL



3D TABLET CONTROLLER

WI-FI REMOTE MANAGEMENT
SYSTEM



MELCloud CITY MULTI

CLOUD REMOTE MANAGEMENT
SYSTEM



MELCOTEL

INTERFACE FOR HOTEL
SIMPLIFIED
APPLICATION



RMI

Remote Monitoring Interface
CLOUD REMOTE MANAGEMENT
SYSTEM



M-NET-AHC- 24VDC

INTEGRATION OF EXTERNAL SIGNALS



B.M.S. INTERFACE

B.M.S. INTEGRATION

PAC-YT52CRA

DESIGN REMOTE CONTROL



PAC-YT52CRA Design remote control

- Display with white backlighting.
- Simple wall-mounted installation.
- Easy and intuitive with icon-based interface.
- Operating mode selection function.
- Vane position selection function (for compatible indoor units).
- Usable to manage 1 group of up to 16 indoor units.
- Simple connection with single non-polarised two-core wire.
- **MA** self-addressing technology.

- Suitable for all types of indoor unit.
- Recommended for hotels and public spaces, as ambient air temperature display can be disabled.
- Integrated temperature sensor usable instead of indoor unit sensor.
- Configurable temperature range settable from local keypad.

Key Technologies

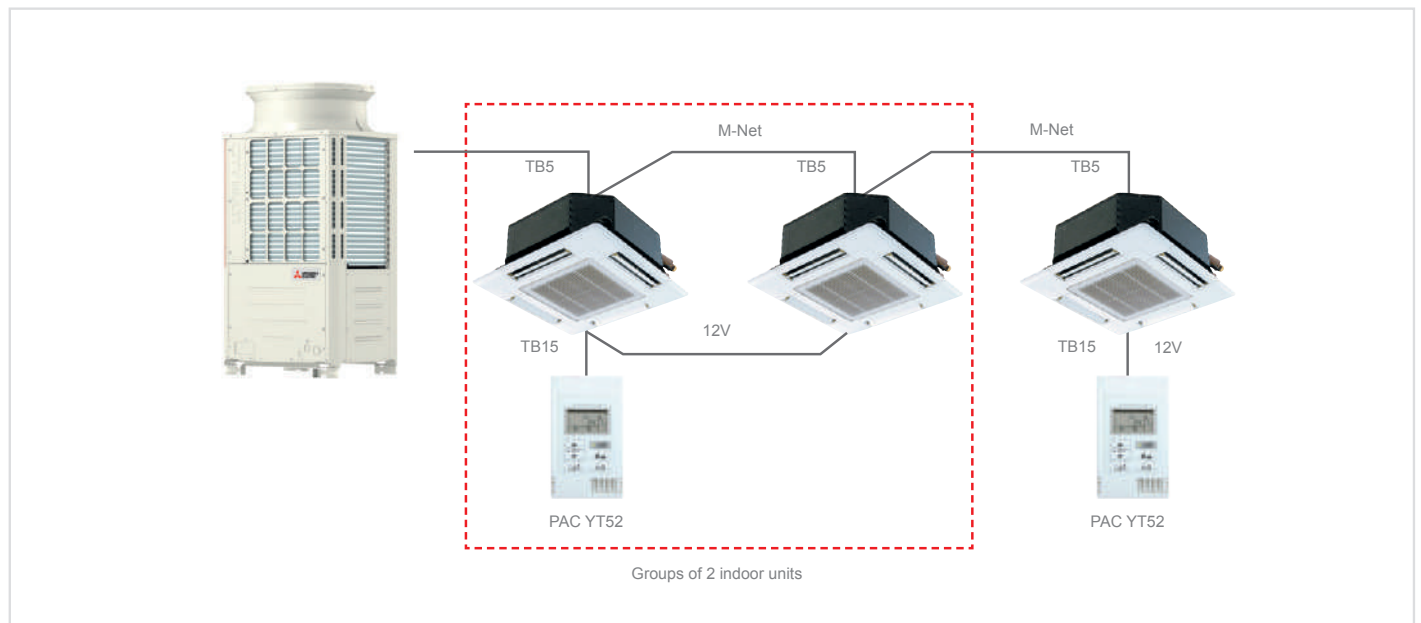

PAR-41MAA NEW

DELUXE REMOTE CONTROL UNIT



PAR-41MAA Deluxe remote control unit

- Display with white (factory setting) or black backlighting and adjustable contrast.
- Simple wall-mounted installation.
- Night Set-back function for setting minimum winter temperature or maximum summer temperature in temperature maintenance mode.
- Effective static overpressure selection function for ducted indoor units (PEFY-P VMHS only).
- Internal weekly timer function and simplified internal timers (Auto-off, etc.).
- Usable to manage 1 group of up to 16 indoor units.
- Easy and intuitive, with icon based graphic interface, direct control buttons and function buttons.
- Simple connection with single non-polarised two-core wire.
- **MA** self-addressing technology.

- Suitable for all types of indoor unit, including GUF.
- Integrated temperature sensor usable instead of indoor unit sensor.
- Configurable temperature range settable from local keypad.
- **View and set setpoint temperatures in 0.5°C increments.**
- Supports 3D i-see sensor functions
- **14 languages available** (English, French, Spanish, German, Italian, Dutch, Portuguese, Greek, Russian, Czech, Turkish, Polish, Hungarian, Swedish).
- Draft reduction *
"Close" has been added to the manual vane angle selection. The air outlet can be closed to reduce drafts from the air conditioner.

Key Technologies

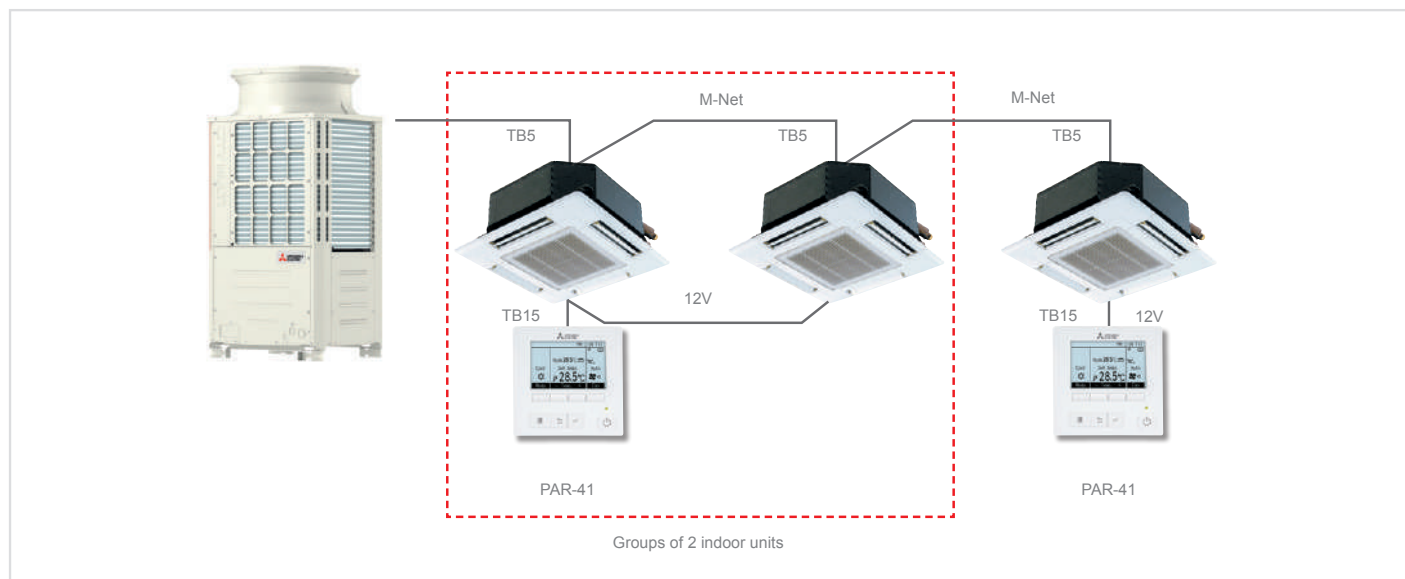

PAR-CT01MA

PRISMA REMOTE CONTROL



PAR-CT01MAA-SB



PAR-CT01MAA-PB

PAR-CT01MA prisma remote control

- Full color touch panel display
- 180 color patterns can be selected for control parameters or background on the display
- Easy wall mounted installation
- Night Set-back function for setting minimum winter temperature or maximum summer temperature in temperature maintenance mode.
- Effective static overpressure selection function for ducted indoor units (PEFY-P VMHS only).
- Internal weekly timer function and simplified internal timers (Auto-off, etc.).
- Usable to manage 1 group of up to 16 indoor units.
- Easy and intuitive, with icon based graphic interface, direct control buttons and function buttons.
- Simple connection with single non-polarised two-core wire.
- MA self-addressing technology.
- Suitable for all types of indoor unit, including GUF.
- Recommended for groups with only one indoor unit.
- Integrated temperature sensor usable instead of indoor unit sensor.
- Configurable temperature range settable from local keypad.
- **View and set setpoint temperatures in 0.5°C increments.**
- **Supports 3D i-see sensor functions for 60 x 60 PLFY-P VFM-E1 cassette and 90 x 90 PLFY-P(M) VEM-E cassette**

Multiple color pattern

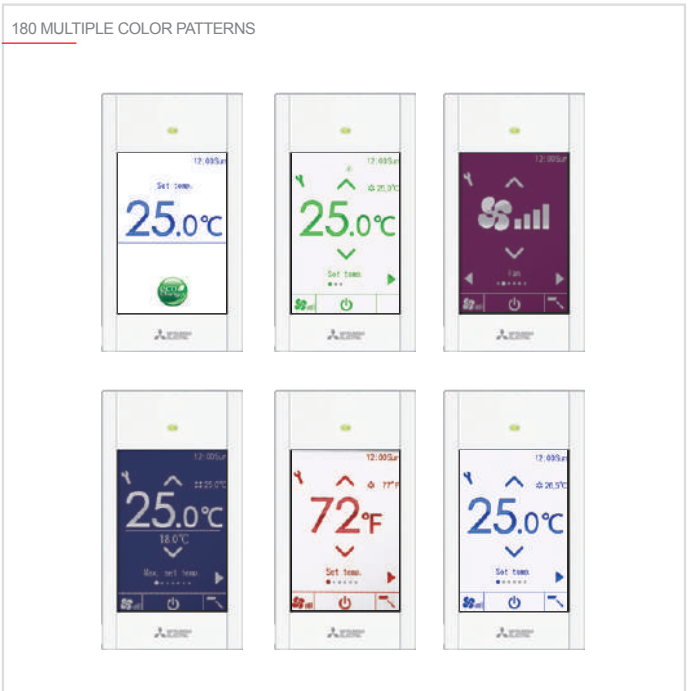

Key Technologies

				
---	--	--	--	--

Multilingual support

The smartphone app can be displayed in the language that the guest's smartphone is set to.

Large color backlit touch display

New PRISMA remote control is equipped by 3.5 inch/HVGA Full Color LCD Touch screen,



Display customization

Customized display, color on parameter and background, editable parameter, logo image on the initial display.

Hotel setting

Simple operation panel is liked by users, especially in hotels. It is available to display only ON/OFF, set temp., fan speed.

Bluetooth connection

PAR-CT01MA remote control is equipped with Low Energy Bluetooth connection. Thanks to two dedicated Apps (one for installers and one for users) it is possible to connect your smartphone or tablet the the remote control. User App allows to control the air conditioning system connected to PAR-CT, with a simple and intuitive interface.

Installer App allows to easily configure the remote control during maintenance and commissioning. Thanks to this App it is possible to save a settings pattern on mobile device and easily transfer it to the remote control, shortening service and commissioning timing.

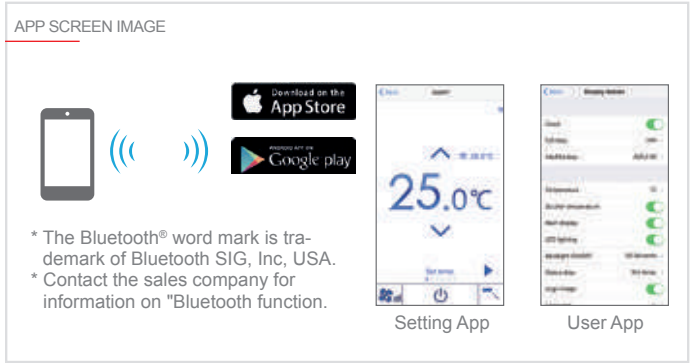

Logo image customization

Logo image can be displayed on the initial screen.



PAR-U02MEDA

ADVANCED REMOTE CONTROL

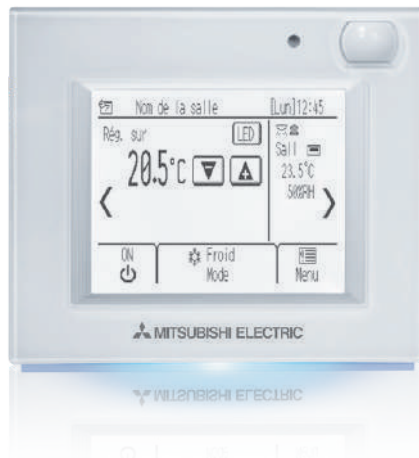

PAR-U02MEDA advanced remote control

The Mitsubishi Electric Advanced remote control may be used to control up to 16 indoor units. While advanced, this controller also offers basic functions such as monitoring and controlling the status of the units in the system, and a weekly hour timer. Four integrated sensors (temperature, humidity, occupancy and light) allow a series of advanced adjustment and control functions. For example, the occupancy sensor can be used to save energy by configuring different modes based on the occupied/vacant status of each room.

- Large monochrome LCD touch screen display with white backlighting.
- Usable to manage 1 group of up to 16 indoor units.
- **Integrated temperature, humidity, occupancy and light sensors.**
- SMART energy saving and comfort functions.

- Contextual colour LED indicating operating status of indoor units.
- **View and set setpoint temperatures in 0.5°C increments**
- **Dual Setpoint** function.
- Internal weekly timer.
- **ME M-Net** addressing technology.
- Extended setting ranges for setpoints (Cool: 19-35°C; Heat: 5-28°C).
- New functions for use in conjunction with AHC Programmable Controller (PLC M-Net), for creating operating strategies with generic devices.

Key Technologies

				
---	--	--	--	--

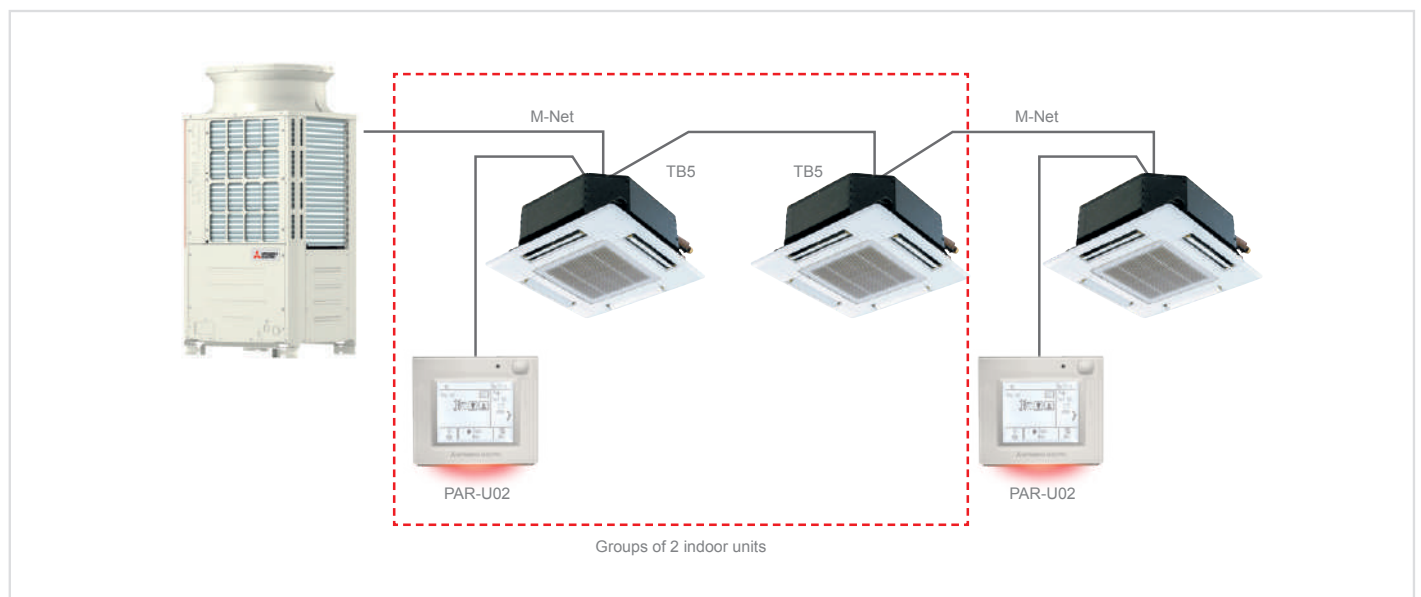

Occupancy sensor

The occupancy sensor detects if a room is vacant and enables automatic control of the indoor units to implement energy saving strategies based on the effective occupancy of each room. The occupancy sensor enables the following energy saving functions:

- Switch indoor units ON/OFF based on occupied/vacant state of room;
- Fan speed control;
- Switch indoor unit from Thermo ON to Thermo OFF state;
- Configure temperature deviation based on occupied/vacant status.

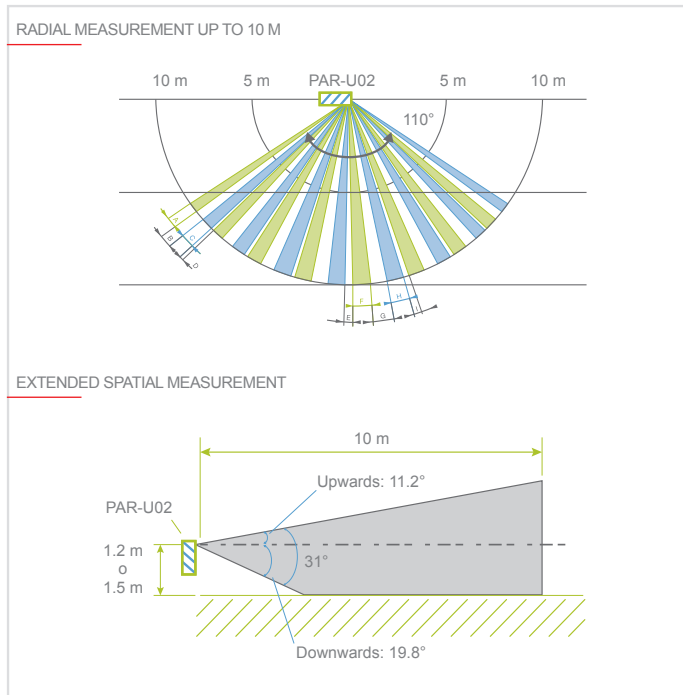

Light sensor

The light sensor measures the light levels in the conditioned room and adjusts the brightness of the remote control display accordingly.

Bright/dark thresholds may be set directly from the remote control over an extended luminosity range (1 to 65535 lx).

The light sensor is also used in low light conditions to confirm the occupied/vacant status of the room.

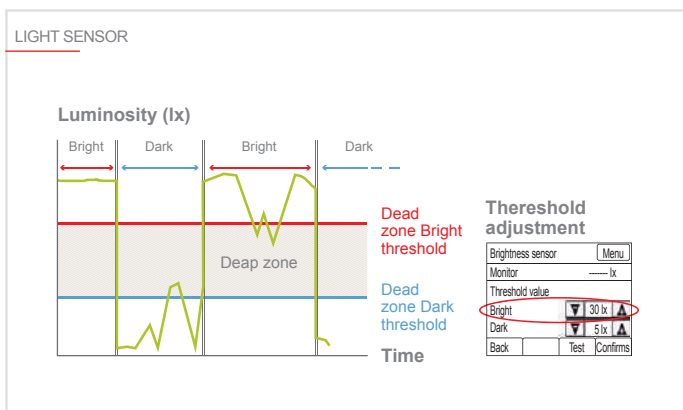

Temperature and humidity sensor

The integrated temperature and humidity sensor may be used to increase perceived comfort levels,

while the ability to adjust the temperature with a precision of 0.5°C gives the user an even greater sense of control. The relative humidity sensor, combined with the ability to interlock the remote control with a programmable AHC controller, makes it possible to control humidity with external devices connected to the system via the AHC.

LED status indicator

The LED status indicator indicates the status of active functions on the remote control. Each colour is associated with a status or function:

e.g. Red=Heating, Blue=Cooling etc.

The LED indicator may be temporarily or permanently disabled.

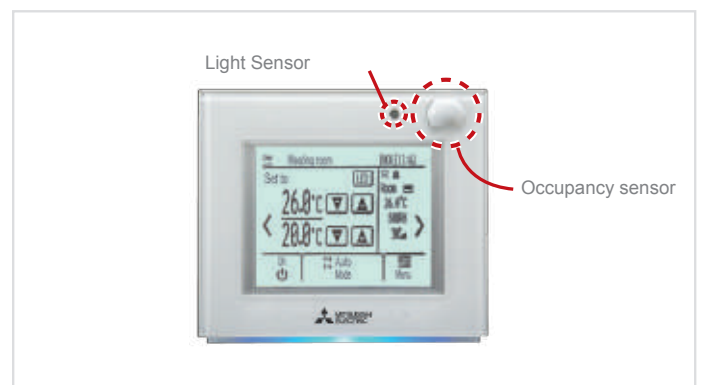
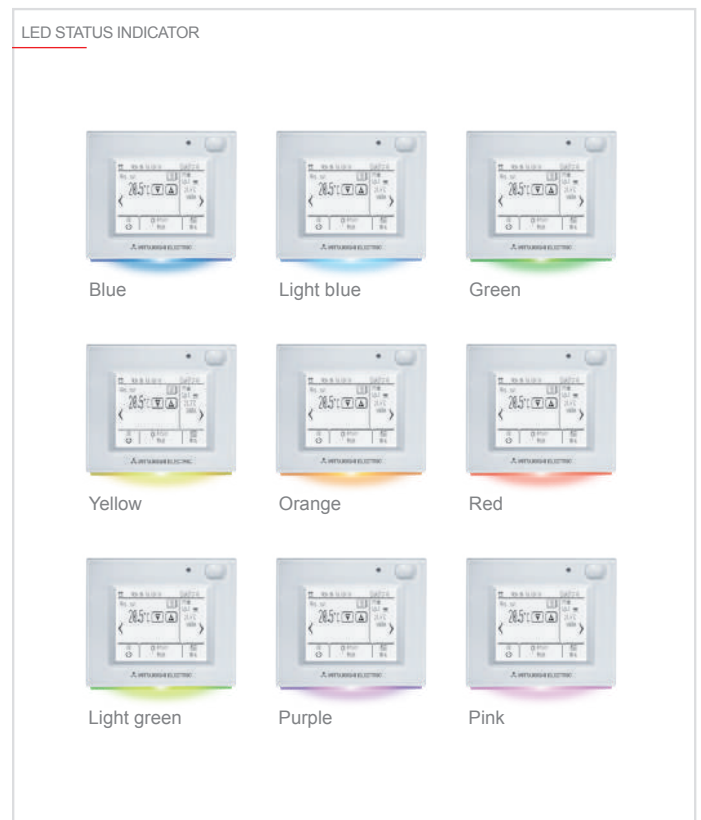

PAR-FL32MA

WIRELESS REMOTE CONTROL



PAR-FL32MA wireless remote control

- Usable to manage 1 group of up to 16 indoor units.
- Easy and intuitive with icon-based interface.
- Receiver connected simply with single non-polarised two-core wire.
- **MA** self-addressing technology.
- Suitable for all types of indoor unit.
- Recommended for groups with only one indoor unit.
- Generic receiver for all indoor unit types: PAR-FA32MA.
- Specific corner receiver for 4-way PLFY-P(M) VEM-E cassette units: PAR-SE9FA.

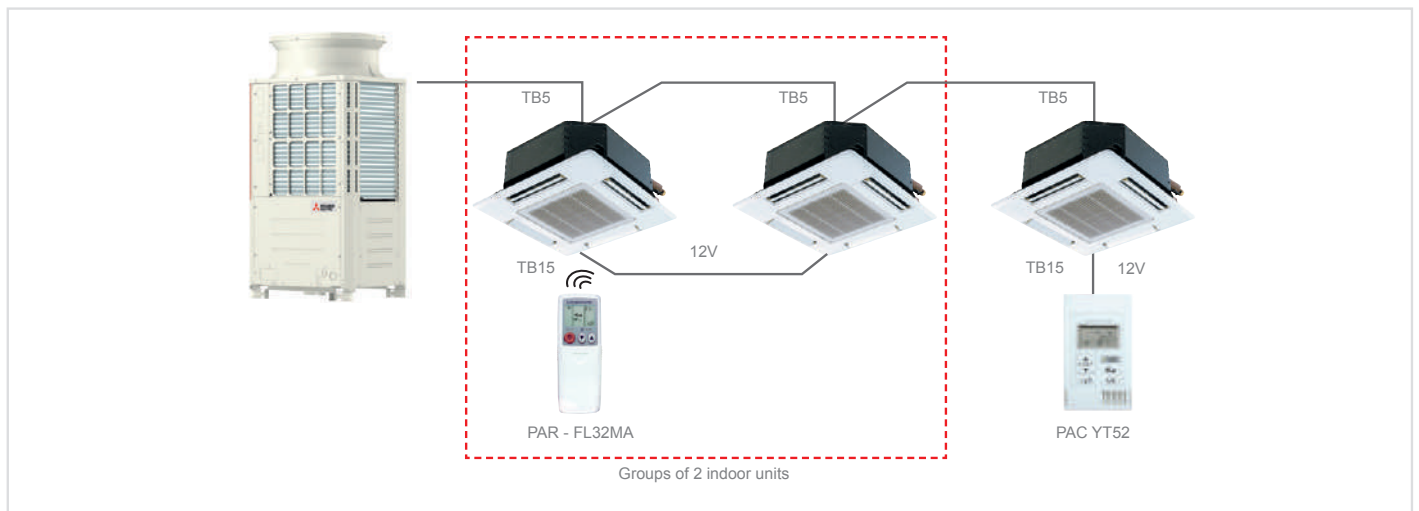

Compatibility table		
	Wireless signal receiver	Wireless remote control
PMFY-P VBM PLFY-P VLMD PEFY-P VMR/VMH PEFY-P VMS1 PEFY-M VMA PEFY-P VMA3 PEFY-P VMHS PFFY-P VLEM/VKM/VCM PCFY-P*VKM	PAR-FA32MA	PAR-FL32MA
PLFY-P/M VEM PLFY-P VFM-E1	PAR-FA32MA	PAR-FL32MA

Compatibility table		
	Wireless signal receiver	Wireless remote control
PKFY-P VLM PKFY-P VKM	Built in	PAR-FL32MA

PAR-SL101A-E

WIRELESS REMOTE CONTROL



Wireless remote control PAR-SL101A-E

- Compatible with PLFY-VFM and PLFY-VEM
- **Backlighting**
- Group with up to 16 units
- **Direct/Indirect function** with corner PAC-SF1ME-E (3D i-see sensor)
- **Single vane control**
- Temperature view and setting 0,5°C
- **3D i-see sensor compatible**

Key Technologies

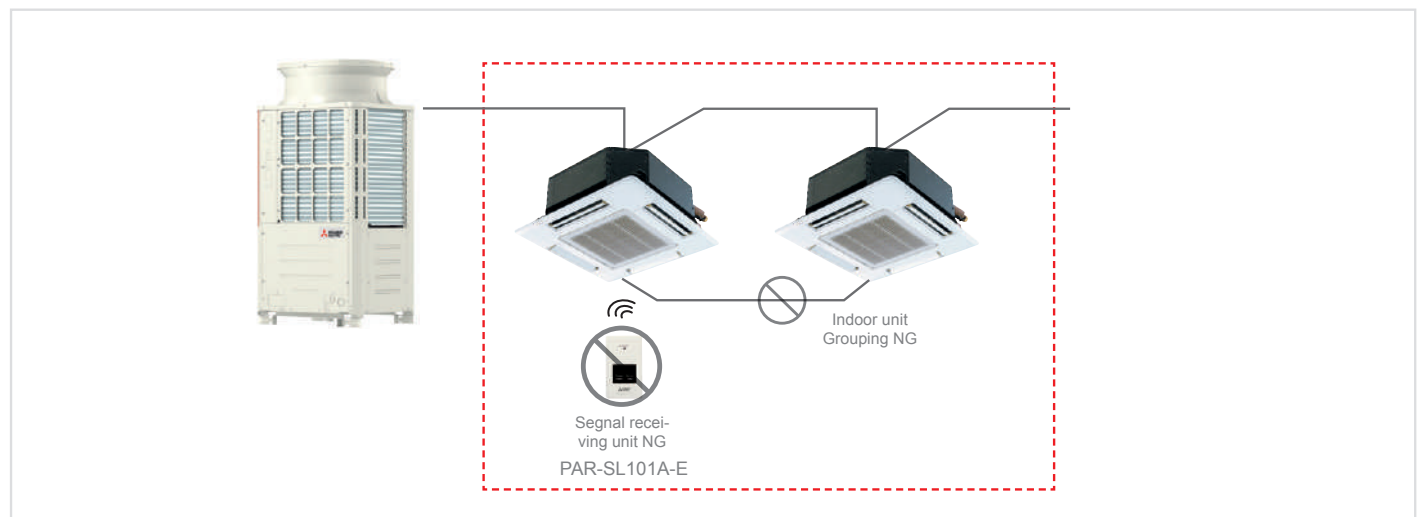

Compatibility table		
	Wireless signal receiver	Wireless remote control
PLFY-P/M VEM-E	PAR-SE9FA-E	PAR-SL101A-E
PLFY-P*VFM-E1	SLP-2FAL	

PZ-62DR-EB

LOSSNAY REMOTE CONTROL



PZ-62DR-EB remote control for Lossnay

- Specific remote control for Lossnay heat recovery units.
- Usable to manage one group of up to 15 Lossnay units.
- Easy and intuitive with icon-based interface.
- Simple connection with single non-polarised two-core wire.
- Internal weekly timer.
- Custom ventilation strategies for mode switching (Auto/recovery/bypass).
- Night purge function for active night-time ventilation in summer.
- On-display service messages.
- Backlit LCD screen.
- Energy management

3 Languages are added
Greek, Slovenian, Denmark

Compatibility
PZ-62DR-EB are compatible with both RVX and RVS.

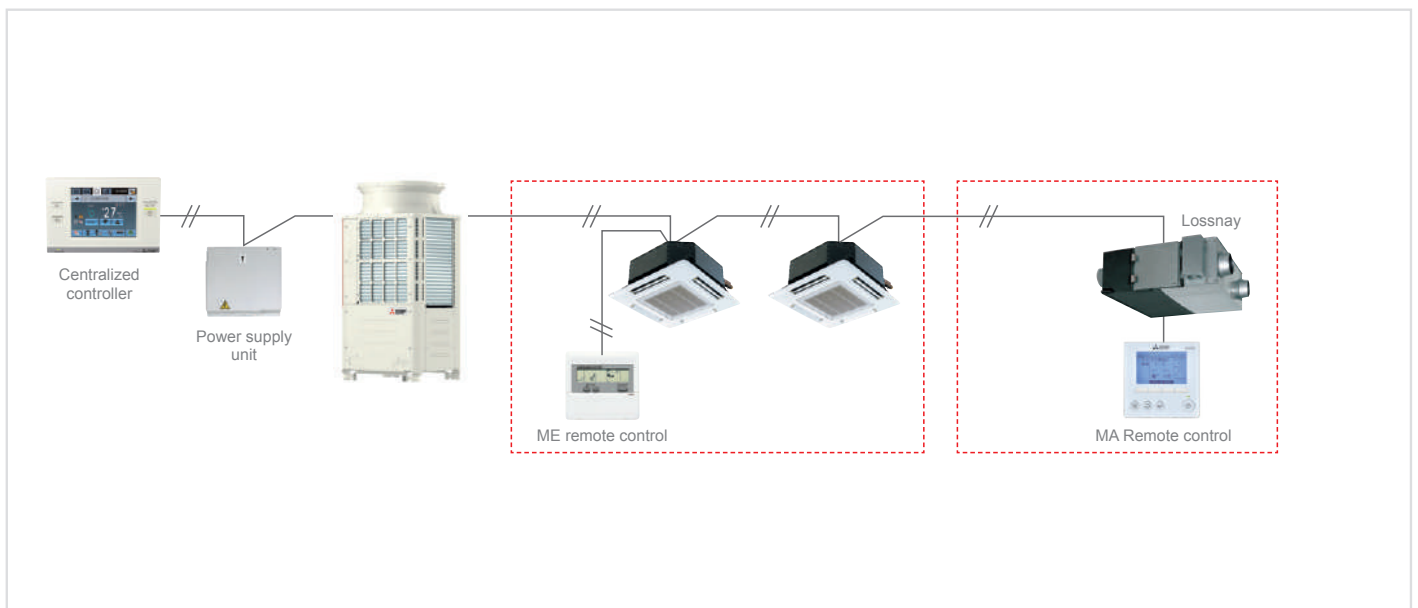

*Not compatible with LGF

Dedicated PZ-62DR-EB wired controller

The new PZ-62DR-EB controller can be used to control all the functions of the LGH-RVS unit.

If the PZ-70CSW-E (optional) or PZ-70CSB-E (optional) CO₂ sensor is used, the carbon dioxide concentration in the room can be displayed on the control unit's display.

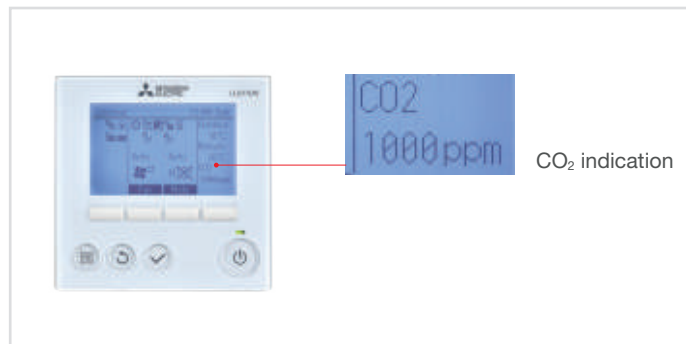

Function	PZ-62DR-E
Fan speed selection	4 fan speeds and Auto (Auto is available when using a CO2 sensor)
Control with a CO2 sensor	Yes (Fan speed automatically changes from 25% to 100% depending on the CO2 concentration*)
Ventilation mode selection	Energy recovery/Bypass/Auto
Night-purge	Yes
Function setting from remote controller	Yes
Bypass temp. free setting	Yes
Multi-stage air flow control	Yes (Both supply and exhaust fan speeds can be set separately from 25% to 100% in 5% pitches)
ON/OFF timer	Yes
Auto-off timer	Yes
Weekly timer	Yes
Fan speed timer	Yes
Operation restrictions (ON/OFF, ventilation mode, fan speed)	Yes
Operation restrictions (fan speed skip setting)	Yes
Screen contrast adjustment	Yes
Language selection	Yes
CO2 concentration indication	Yes (available when using a CO2 sensor)
Filter cleaning sign	Yes (maintenance interval can be changed)
Error indication	Yes (displays model name, serial number, contact information if they are input)
Error history	Yes
OA/RA/SA temp. display	Yes

* When using a CO₂ sensor. Upper and lower limits may be changed.

PAR-W21MAA / PAR-W31MAA

ECODAN REMOTE CONTROL



PAR-W21MAA / PAR-W31MAA remote control for hydronic modules and HWHP units / E-SERIES

- (PAR-W21MAA) Remote control for hydronic modules, HWS and ATW units and Hot Water Heat Pump package systems (HWHP) CAHV&CRHV.
- Usable to manage 1 group of up to 16 indoor units.
- Easy and intuitive with icon-based interface.

- Simple connection with single non-polarised two-core wire.
- MA self-addressing technology.
- Operating mode selection (Heating, Heating ECO, Hot water, etc.).
- Internal weekly timer.
- Customisable water temperature ranges for switching operating mode from local keypad.
- On-display service messages.
- PAR-W31MAA specific for E-SERIES



AT-50B

SYSTEM CONTROLLER



AT-50B system controller

- **5" backlit LCD touch screen.**
- Usable to manage 50 groups of up to 50 indoor units.
- Individual or collective group control, with groups displayed in grid, list or group format.
- **Dual-Setpoint** function.
- **View and set setpoint temperatures in 0.5°C increments.**
- Two weekly timers (for seasonal switching) and one daily timer.
- Simple connection with single non-polarised two-core wire.
- ME M-Net addressing technology.
- Two function buttons programmable to access any of a choice of functions (Night Set-back, weekly hour timer setting, switch operating mode, adjustable temperature range restriction, local restrictions).
- Recommended for controlling a single system.

Key Technologies

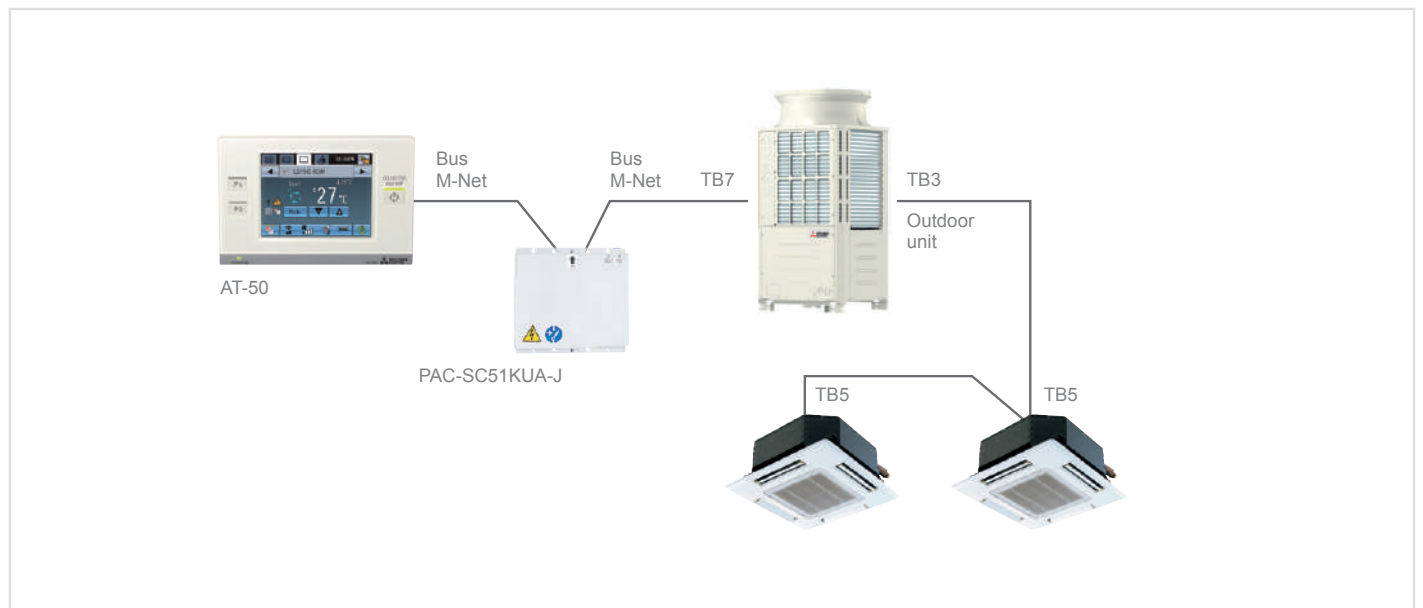

AE-200E

WEB SERVER CENTRALIZED CONTROLLER



3D TOUCH controller

- Generously sized backlit 10.4" SVGA touch screen with graphic layout display function.
- Built-in 240 V AC 50 / 60 Hz power supply.
- Standalone configuration: management of up to 50 indoor units.
- Extended configuration: management of up to 200 indoor units (with 3 expansion controllers EW-50).
- Individual or collective control of groups, blocks or zones.
- Ethernet interface for connection to BMS supervisor systems.
- Integrated WEB server software for management using Internet Explorer®.
- Integrated 2 GB SD memory card for storing system data.
- Direct management of 4 impulse meters with no external interface.
- Power consumption data for billing downloadable via internet connection.
- Complete support for all advanced RMI platform functions for energy consumption monitoring and for multi-installation and multi-user management.
- Temperature setpoints settable and viewable with a precision of 0.5°C.
- Energy saving functions: Maintenance temperature, Sliding temperature, Optimised start, Dual Setpoint.
- M-Net interfacing with Ecodan package Hot Water Heat Pump systems (CAHV and CRHV).
- **Allows direct connection to BMS BACnet NEW**

Superior management, functional and monitoring capabilities with new Mitsubishi Electric controller systems

The 3D TOUCH Controller supports the management, operational and monitoring capabilities of all the new functions offered by the new **ADVANCED remote control**.

Information concerning **occupancy, light levels**, relative humidity in the **indoor space and dual setpoints** is accessible directly from the display and via the WEB.



Key Technologies

				
---	--	--	--	--

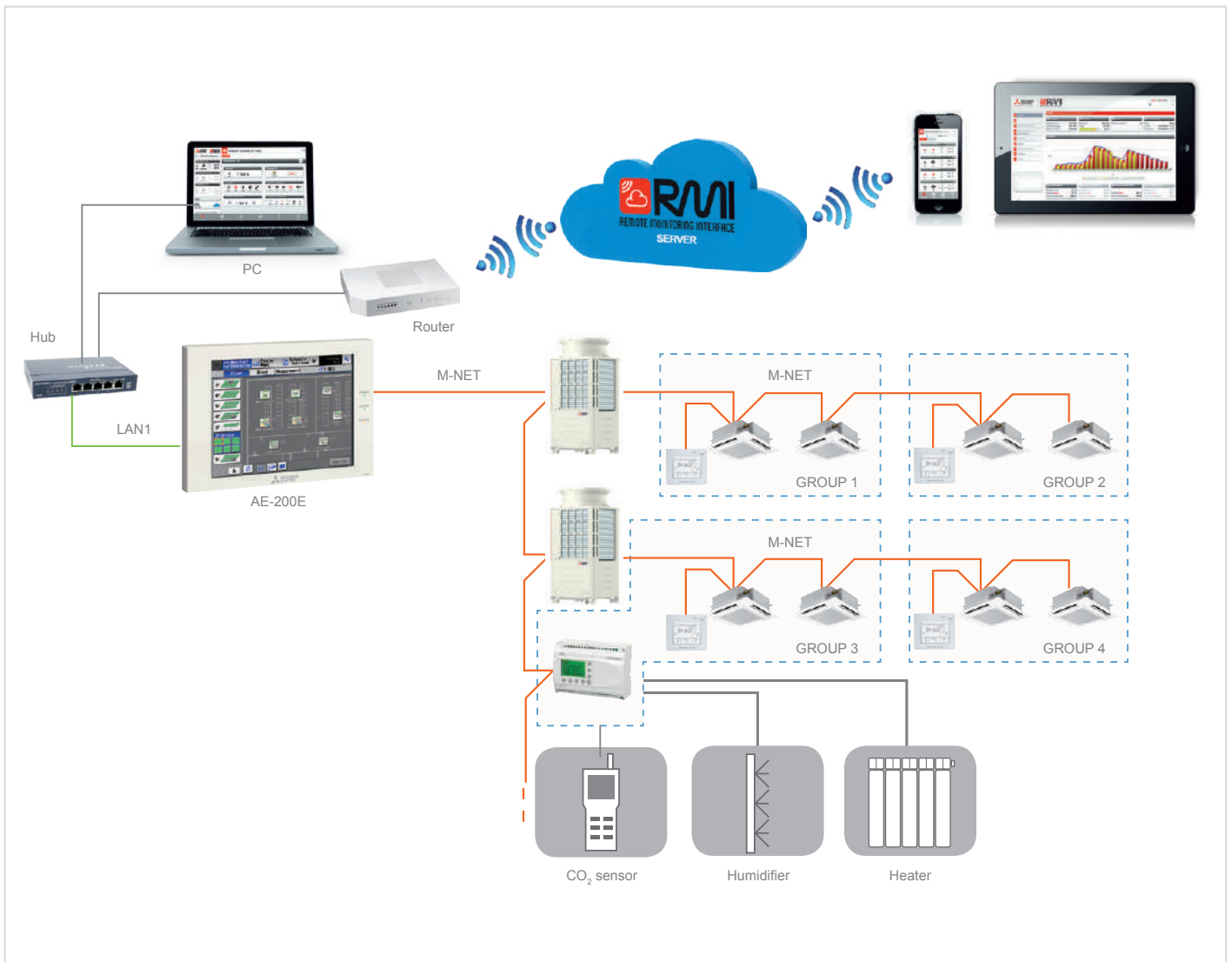

Power and flexibility in a compact device

While measuring practically the same as the previous AG-150, the new 3D TOUCH Controller WEB Server centralized controller offers a larger screen area, greater processing power and expandable flexibility for future applications.

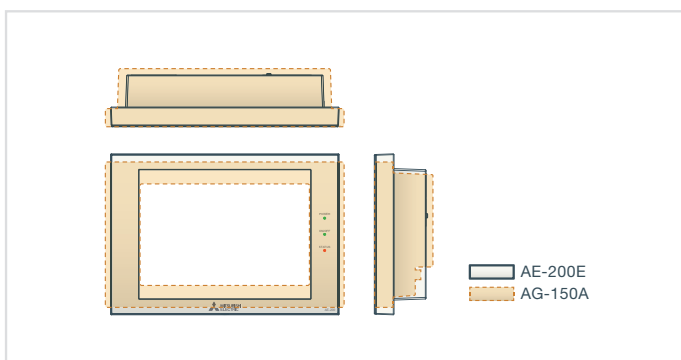

RMI Ready



The **3D TOUCH Controller WEB Server** centralized controller performs the crucial role of acquiring and monitoring data via the M-Net data transmission bus linking all the components of the VRF CITY MULTI, Mr. Slim or Residential system.

A router (available as wired ADSL or 3G Mobile versions) creates a secure, protected communication channel with the RMI Server. The modular flexibility of the RMI Server makes it possible to store enormous volumes of data, which is acquired, processed and archived for access from portable devices.

This infrastructural complexity, combined with superior processing, management and security capabilities, is encapsulated in an extremely user friendly concept, to help users optimise the energy usage of their systems.

EW-50

WEB SERVER CENTRALIZED CONTROLLER



3D blind controller

- “Black Box” version (no display).
- Compact dimensions (external 230V AC power supply).
- Usable to manage 50 groups for a total of up to 50 indoor units.
- Individual or collective group control.
- Ethernet interface for connection to supervisor systems.
- Integrated WEB server software for management using Internet Explorer®.
- Simplified connection, with single non-polarised two-core wire, using ME technology.
- Integrated 2 GB SD memory card for storing system data.
- Direct management of 4 impulse meters with no external interface.

- Status indicator LED indicating data transmission status and/or errors.
- Consumption data for billing downloadable via internet connection.
- A wide choice of energy saving functions offered as standard, with additional optional functions accessible with PIN code licenses.
- Complete support for all advanced RMI platform functions for energy consumption monitoring and for multi-installation and multi-user management.
- **Expansion controller for AE-200.**
- Allows direct connection to BMS BACnet NEW

Key Technologies

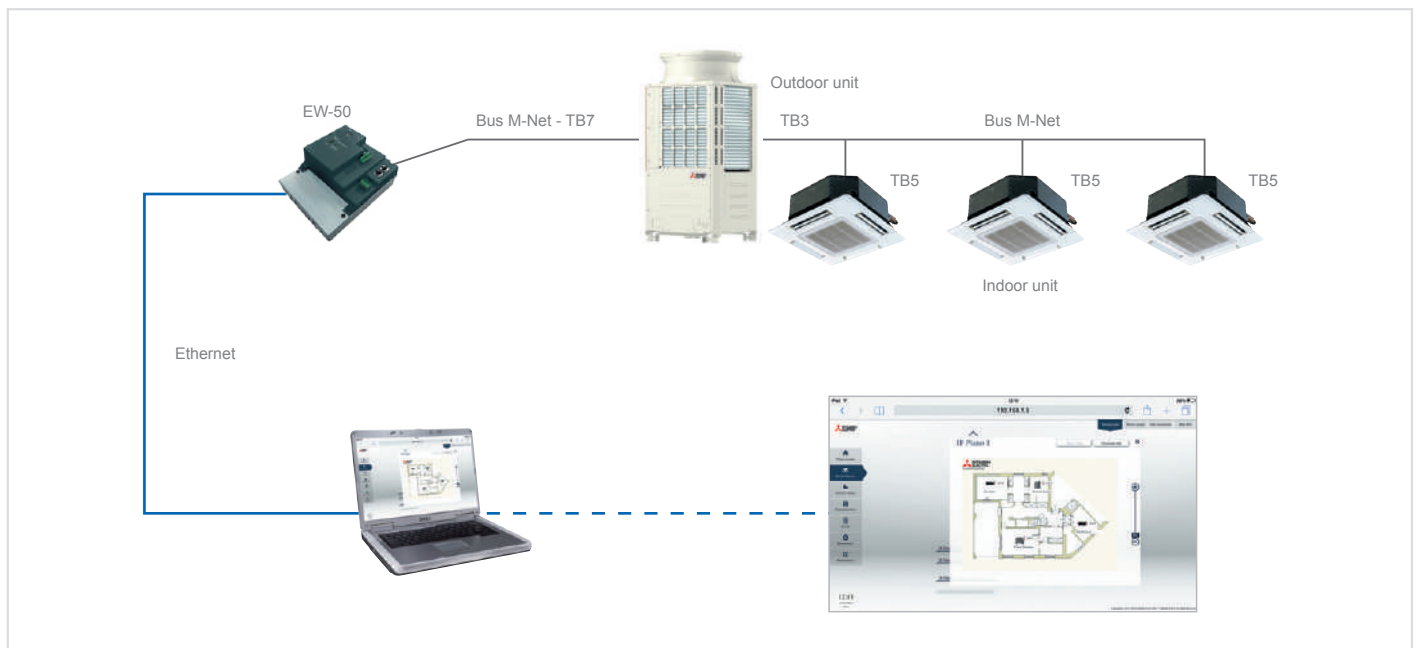

CHARGE

"CHARGE" SYSTEM FOR CENTRALIZED WEB SERVER CONTROLS

Apportioning system by web server centralized controllers

The Charge consumption monitoring and apportioning system may be used to meter the consumption of electric power, thermal power and water for air conditioning, air and/or water heating and domestic hot water production with a Mitsubishi Electric VRF CITY MULTI system, and calculate individual usage values.

The AE-200 and EW-50 CHARGE systems use proprietary Mitsubishi Electric calculation and apportioning methods. This consumption apportioning method indicates the consumption parameters of each user

as percentages of the total consumption of the system. Consumption values, as percentages and kWh, may be calculated separately for:

- Outdoor Units
- Indoor Units
- Ecodan HWS Hydronic Modules
- Ecodan ATW Hydronic Modules

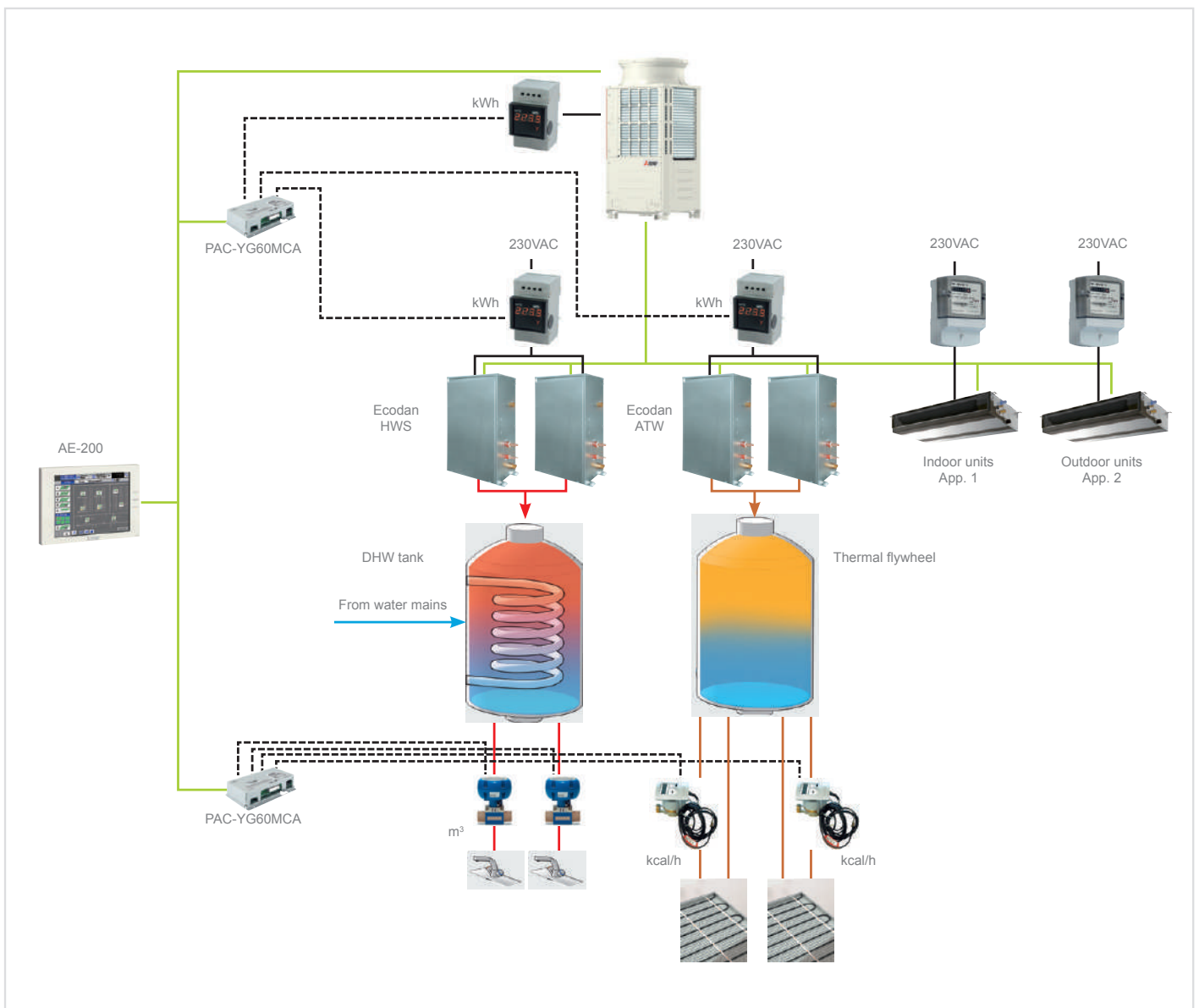

MELCOTEL

INTERFACE FOR HOTEL SIMPLIFIED APPLICATION



MELCOTEL

- Integrated solution interface for small-medium hotels;
- Centralized solution;
- Higher level of control and therefore greater energy saving and a substantial reduction in running costs;
- Key Card contact and Window contact management (1 PAC-SE55RA for each indoor unit is required)
- It works in combination with 1 AE-200 and up to 3 more Web Server Centralized Controllers AE-200/EW-50 (up to 200 Indoor Units).

HOTEL ROOM MANAGEMENT

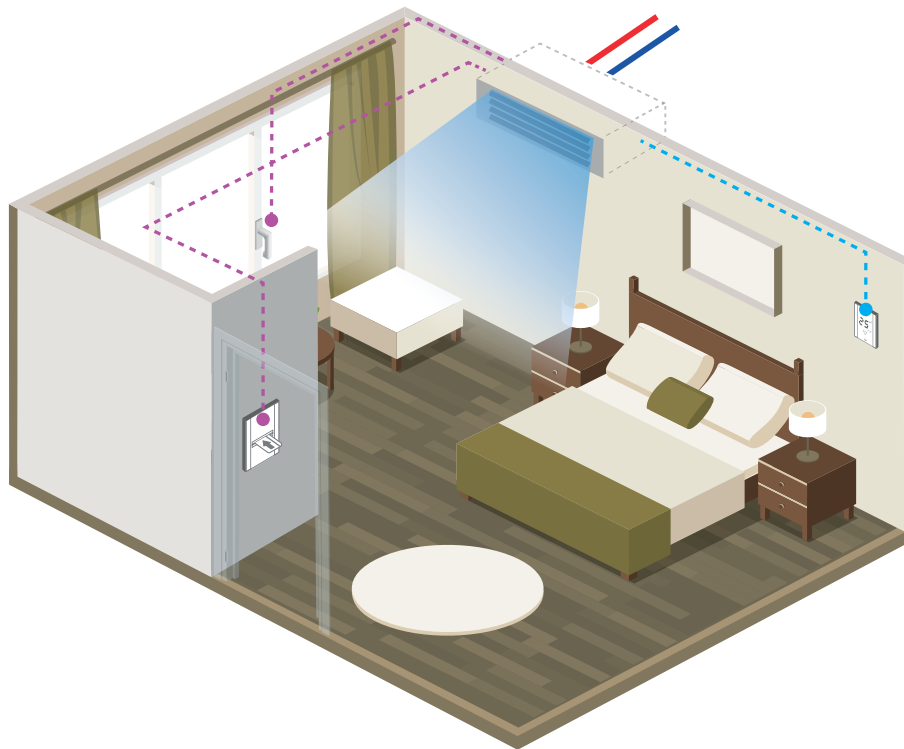

Key card contact and window contact management

The Melcotel Interface allows a hotel to have more accurate control over its air conditioning and can be used to control and monitor up to 200 bedrooms.

KEY CARD CONTACT MANAGEMENT

It allows the resetting of the status (Setpoint Temperature) set by Melcotel when key card is reinserted

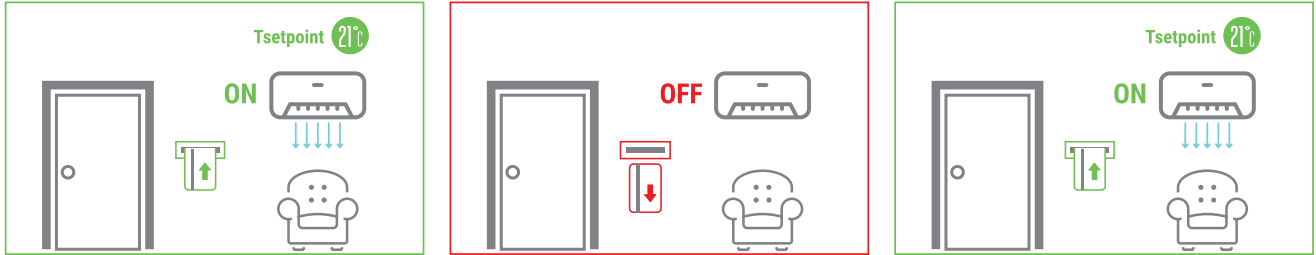

Application example:

When key card is inserted, the indoor unit switches on with the setpoint temperature set by MELCOTEL, for example 21°C. The chamber customer changes the setpoint to 24°C. When key card is removed the indoor unit switches off and remote control is disabled. When key card is reinserted, the indoor unit switches to ON with the setpoint of 21 °C, the one set by MELCOTEL, in order to guarantee energy savings.

WINDOW CONTACT MANAGEMENT

It allows restoring the previous state (ON / OFF status, Setpoint Temperature) when the window is reclosed;

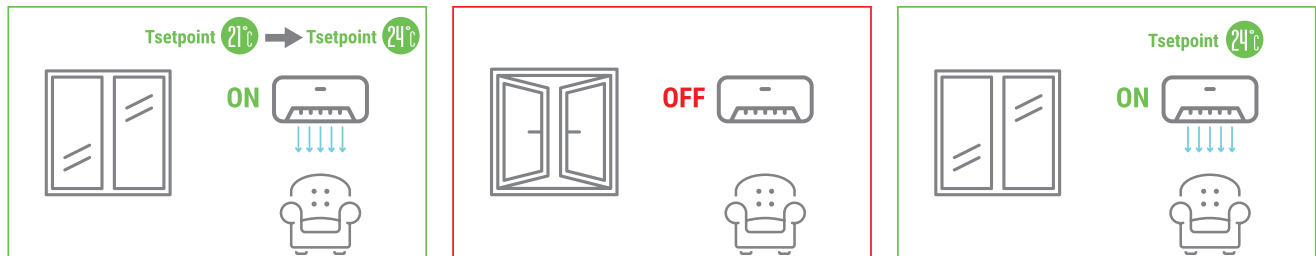

Application Example:

The indoor unit is on and with a setpoint temperature equal to that set by MELCOTEL, for example 21°C. The chamber customer changes the setpoint to 24°C. When the window is opened, the indoor unit switches off and remote control is disabled in order to avoid energy waste. When the window is reclosed, the state prior to opening is restored, i.e. the indoor unit returns to ON and to the setpoint previously set by the customer chamber, i.e. 24 ° C.

ARCHITECTURE

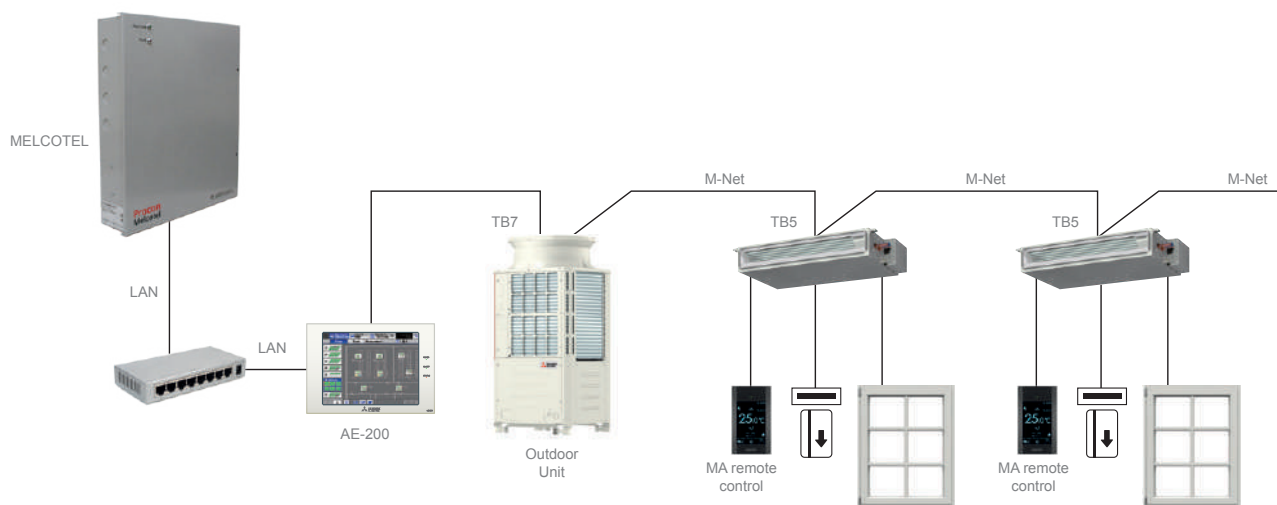

First Centralized Controller HAVE to be necessarily AE-200;
 In order to implement the window and/or key card contact system it is necessary to provide one PAC-SE55RA for each indoor unit.





Remote monitoring and control system



3D Tablet Controller

3D Tablet Controller is the new solution by Mitsubishi Electric

allowing portable system management from Smartphone and Tablet **inside the building**. User configuration, with restrictions and privileges, makes it the ideal solution in those application serving different environments, such as offices or apartments. Thanks to its simple and intuitive interface the user is able to control and monitor **air conditioning** and **hot water production** units on **mobile device**, just as easily as he would on a traditional remote control.

This is possible thanks to WEB Server 3D centralized control installed on site, connected to the building Wi-Fi router*1.

*1 Not supplied by Mitsubishi Electric.

INSIDE THE BUILDING



 **MELCloud®** MELCloud
CITY MULTI



• Cloud remote **monitoring and control** system.

- Born for residential applications, it's now being expanded to VRF CITY MULTI.
- **Complete and intuitive** solution with all main control and monitoring functions.
- Does not require WEB Server 3D centralized control (AE-200, EW-50).

 **RMI** RMI
REMOTE MONITORING INTERFACE

• Cloud remote monitoring and control system **for professional use.**

- Allows all main remote control and monitoring functions.
- **Advanced energy monitoring** features are available, such as hourly consumption view, custom charts and data collection and display.
- Geo-localized **multi-site** management.
- **Multi-user** management for centralized systems.
- **Energy consumption apportioning***2.

			
Group/Individual simplified management*2	•	•	•
Available for Smartphone and Tablet	•	•	•
Dedicated App		•	•
User restrictions	•	•	•
Outside the building (Cloud)		•	•
Internet connection needed		•	•
WEB Server centralized control needed	•		•
Advanced energy monitoring			•
Monthly/Custom charts and reports			•
Multi-site management			•
Energy consumption apportioning			•

*2 For compatible product lines please refer to catalogues or contact headoffice

OUTSIDE THE BUILDING



3D TABLET CONTROLLER

WI-FI REMOTE MANAGEMENT SYSTEM



New Wi-Fi management system by Mitsubishi Electric

3D Tablet Controller allows system management and control through Smartphone and Tablet under LAN Wi-Fi coverage.

Simple and intuitive interface

Thanks to its simple and intuitive interface the user is able to freely control air conditioning and water production units from mobile device, inside the building.

This interface has been designed to have the look&feel of a typical App for Smartphone, with immediate feedback from units and fast setting of operating parameters.

Access and components

WEB Server centralized control connected to Wi-Fi router is needed. 3D Tablet Controller is compatible with all Smartphone and Tablets, thank to access through internet browser.

The user can login at the address:

[http://\[AE-200/EW-50 IP address\]/mobile](http://[AE-200/EW-50 IP address]/mobile)

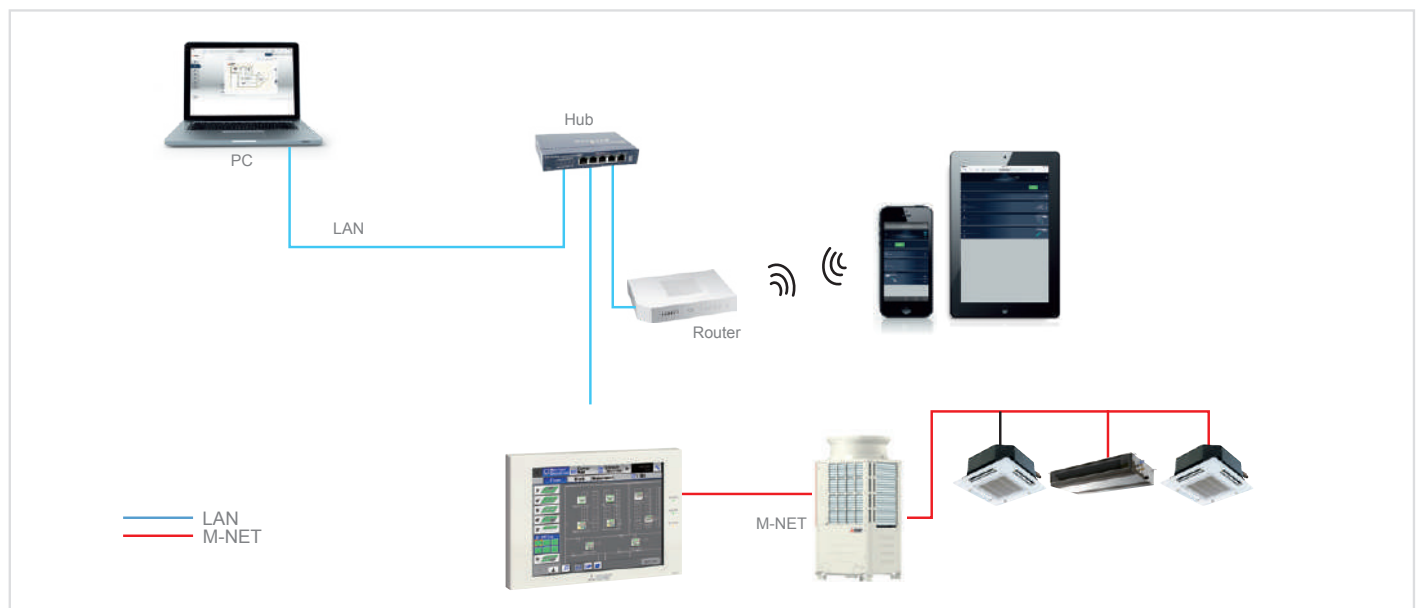



Mobile interface

The web interface has been designed following the modern style of App for Smartphone and Tablet, maximizing easy of use and intuitiveness for mobile use.

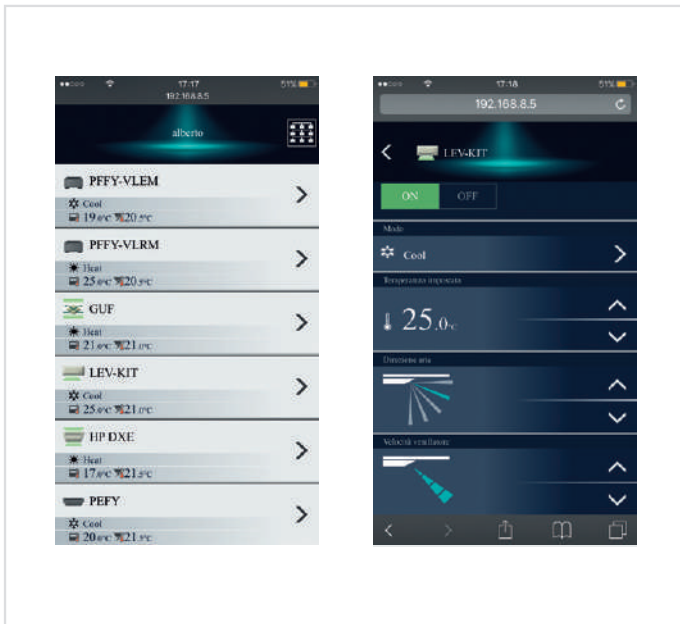

Advantages

- Compatible with all Smartphone and Tablet mobile devices, regardless of the brand and operating system.
- No need for internet connection, communication is direct between device, router and centralized controller.
- Possibility to replace the wired remote controls
- Possibility of configuring different users with privileges/restrictions on the available functions

MELCLOUD CITY MULTI

CLOUD-BASED REMOTE MANAGEMENT AND SUPERVISOR SYSTEM



MELCloud, the Wi-Fi controller for VRF CITY MULTI systems.



MELCloud, the new Wi-Fi controller for your Mitsubishi Electric VRF system. By using the cloud for sending and receiving information and the dedicated Wi-Fi interface (MAC-567IF-E), you

can now control your VRF system easily wherever you are from any PC, tablet or smartphone with an internet connection.

The MELCloud service has been designed to ensure complete compatibility with PCs, tablets and smartphones via dedicated apps or via a web browser

Registering the system

The system must be registered to activate the MELCloud service. Once the interface is connected to the indoor unit and paired with the router, the system itself may be registered. To activate Wi-Fi control capability, simply access the website www.melcloud.com, sign up as a user and register the interface used. After registering, you will be able to take full advantage of the potential offered by the MELCloud service and manage your VRF system from any location over the internet.

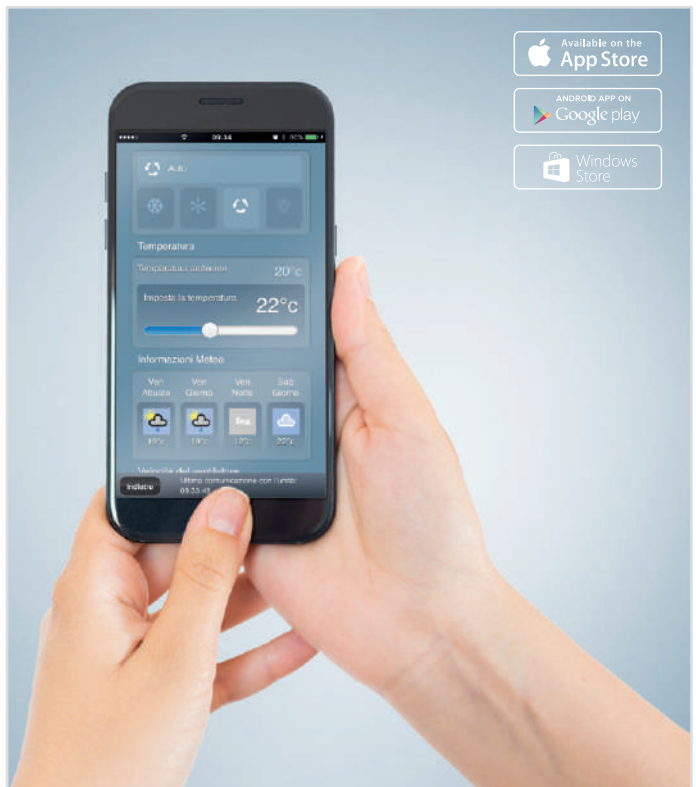

REMOTE MONITORING INTERFACE

CLOUD REMOTE MANAGEMENT SYSTEM



The Cloud system by Mitsubishi Electric for large installations

The RMI system lets you control your air conditioning, heating and domestic hot water production system remotely from a smartphone, tablet or PC. The system may be used to monitor the performance of your appliances, programme functions, check consumption and view operating states to optimise the efficiency of the system.

Your perfect climate in an App!

Control your air conditioner, adjust temperature and air flow settings, view and manage hot and cold water production status and check for system faults.

Simplified control for all of your systems

Set weekly programmes and special events, and view and analyse the operating parameters of your system remotely from a mobile device with a graphic interface that lets you change settings instantaneously when needed.



ALL FROM AN APP ON YOUR SMARTPHONE OR TABLET.

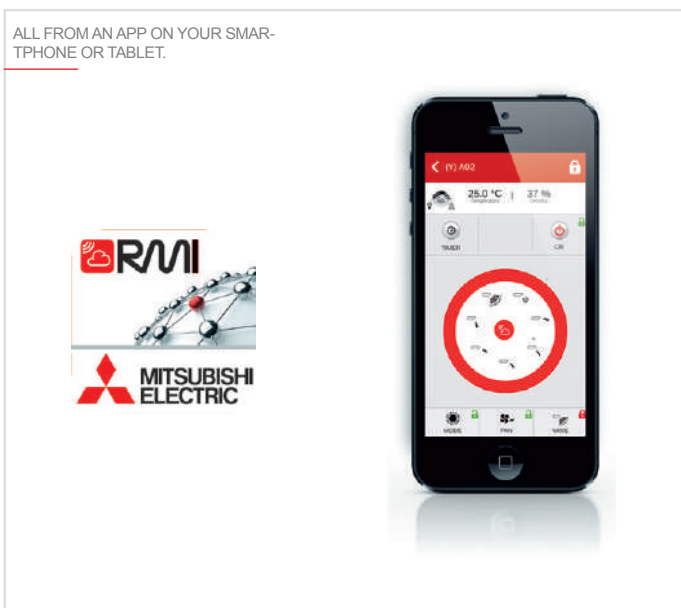

Manage your systems with detailed information and analytical functions

Manage multiple installations with different sizes and architectures conveniently from the application on your PC, view function parameters in a summarised dashboard interface, and analyse specifically created reports to make your installation work even more efficiently. RMI is also the ideal solution for the centralized management and supervision of multiple installations in different locations.



System architecture

The 3D TOUCH Controller WEB Server centralized controller performs the crucial role of acquiring and monitoring data via the M-Net data transmission bus linking all the components of the VRF CITY MULTI, Mr. Slim or Residential system.

A router (available as wired ADSL or 3G Mobile versions) creates a secure, protected communication channel with the RMI Server. The modular flexibility of the RMI Server makes it possible to store enormous volumes of data, which is acquired, processed and archived for access from portable devices. This infrastructural complexity, combined with superior processing, management and security capabilities, is encapsulated in an extremely user friendly concept, to help users optimise the energy usage of their systems.

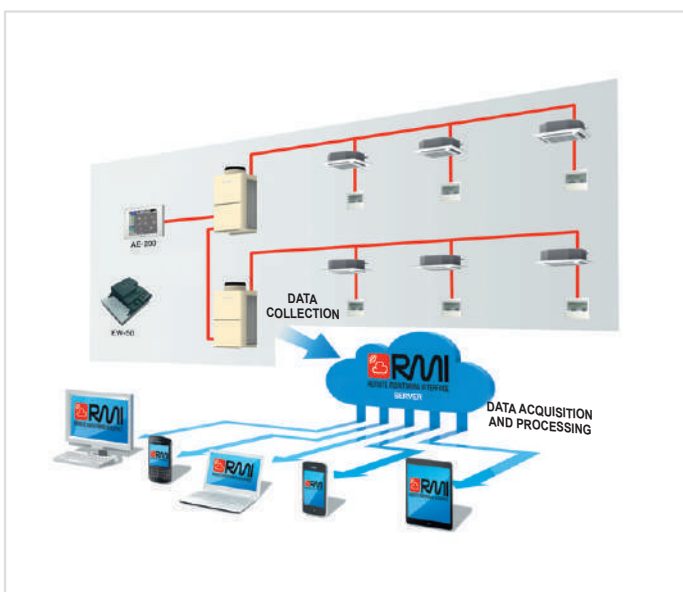

The project

The RMI project is the result of a forward thinking idea by Mitsubishi Electric to offer its customers the capability of managing their installations from portable devices, adding a significant new advantage offered by these systems. The all-new **RMI** system is the **FIRST** system of its kind based on **Cloud Computing** technology, which lets you interface with your system via a simple yet secure internet connection. RMI makes it possible to manage Mitsubishi Electric air conditioning solutions, with **energy consumption monitoring and maintenance functions**, from **smartphone** and **tablet** apps for the iOS and **Android** operating systems, and via a private **WEB Client** area **from a PC**. The RMI system is based on a dedicated infrastructure (RMI Server), which may be described as a container for installation data that is collected and made accessible **simply and intuitively**, and filtered and represented appropriately for the type of user analysing and using the data.

The project was designed from the start with security in mind, to protect the installation and the client against unauthorised access with a secure VPN connection (Virtual Private Network).

Who can use RMI?

Because of its many different functions, the RMI system is suitable for all types of installation, from centralized residential systems to commercial applications and large scale installations.

The remote management and monitoring functions are intended for end users (e.g. tenants), owners, administrators, energy/building managers, global service providers and installing and maintenance technicians.

RMI Service packages

RMI can also be applied to an existing VRF CITY MULTI system, by interfacing through the installation's existing WEB Server centralized controllers. Contact head office to check compatibility between hardware and available functions

See DEMO RMI at:

<http://demo-it.rmi.cloud>

RMI IS AVAILABLE IN THE FOLLOWING PACKAGES

 **RMI SMART**
REMOTE MONITORING INTERFACE

 **RMI ADVANCED**
REMOTE MONITORING INTERFACE

 **RMI MULTI-TENANT**
REMOTE MONITORING INTERFACE

 **RMI PLAN**
REMOTE MONITORING INTERFACE

 **RMI CHARGE**
REMOTE MONITORING INTERFACE

ADVANCED HVAC CONTROLLER

EXTERNAL SIGNAL INTEGRATION



AHC – Advanced HVAC controller

- Solution consists of an ALPHA2 PLC and an M-Net interface, both by Mitsubishi Electric.
- Intuitive object-based graphic programming function.
- Create control strategies using either physical signals (inputs and outputs) or logical signals (via M-Net data transmission bus).
- Receive signals from 2 Groups for a total of up to 32 indoor units for each PLC.
- Programme synchronised energy saving strategies between power consuming utilities (such as lighting) and the air conditioning system.
- 15 inputs and 9 outputs.
- Number of physical inputs and outputs may be increased with dedicated expansion modules.
- Large backlit LCD display for programming functions and viewing graphics, text and values.
- Direct programming with 8 function keys on front control panel without using auxiliary devices.
- Superior installation flexibility with integrated DIN rail adapter.
- System may be password-protected.
- Possibilità di proteggere il sistema mediante password.

Total integration

The AHC programmable controller uses Mitsubishi Electric know-how acquired in industrial automation applications to integrate air conditioning, heating and domestic hot water production systems with third party systems, such as access control, security, lighting control systems etc., allowing communication between the systems via the M-Net data communication bus.

This makes it possible, for example, to use data acquired via the M-Net communication bus to control external devices instead of interlocking the operation of air conditioner units and external systems connected to the AHC Programmable Controller, or using other similar measures.

Flexible programming...

Up to 200 function blocks can be used in a single application (Set/Reset, Timer, Service messages etc.), offering extraordinary scope for controlling the entire installation.

... and safe data!

The application is stored permanently in an EEPROM memory module. This means that active data (such as meter counts) are backed up without requiring power.

Extensive operating temperature range

Designed to operate in a temperature range from 25°C to 55°C and with an IP20 protection rating, these devices are ideal for both indoor and outdoor installation.

Digital and analogue expansion modules

Dedicated expansion modules offer the possibility of increasing the number of both analogue and digital inputs and outputs.

Digital

AL2-4EX:

offers 4 digital inputs

AL2-4EYT:

offers 4 digital outputs

Analogue

AL2-2PT-ADP:

offers 2 analogue inputs

AL2-2DA:

offers 2 analogue outputs

LMAP04

BMS INTERFACE FOR LONWORKS® NETWORKS



LMAP04 BMS interface for LonWorks® networks

The LMAP04 interface allows Mitsubishi Electric air conditioners to communicate with third party BMS supervisor and management systems through the LonWorks® network system. The hardware of the interface consists of an electronic board with software integrated in the board itself which needs no configuration.

The LMAP04 interface may be installed with any remote control or centralized controller of the Mitsubishi Electric range. The LMAP04

interface can also be used in a mixed system, which also includes the TG-2000A supervisor. Each LMAP04 interface can control up to 50 indoor units, each with its own unique address. In installations with AE-200E or EW-50 WEB Server centralized controllers, the LMAP04 interface offers the same modularity as the controllers themselves. In these cases, a separate interface must be installed for each centralized controller.

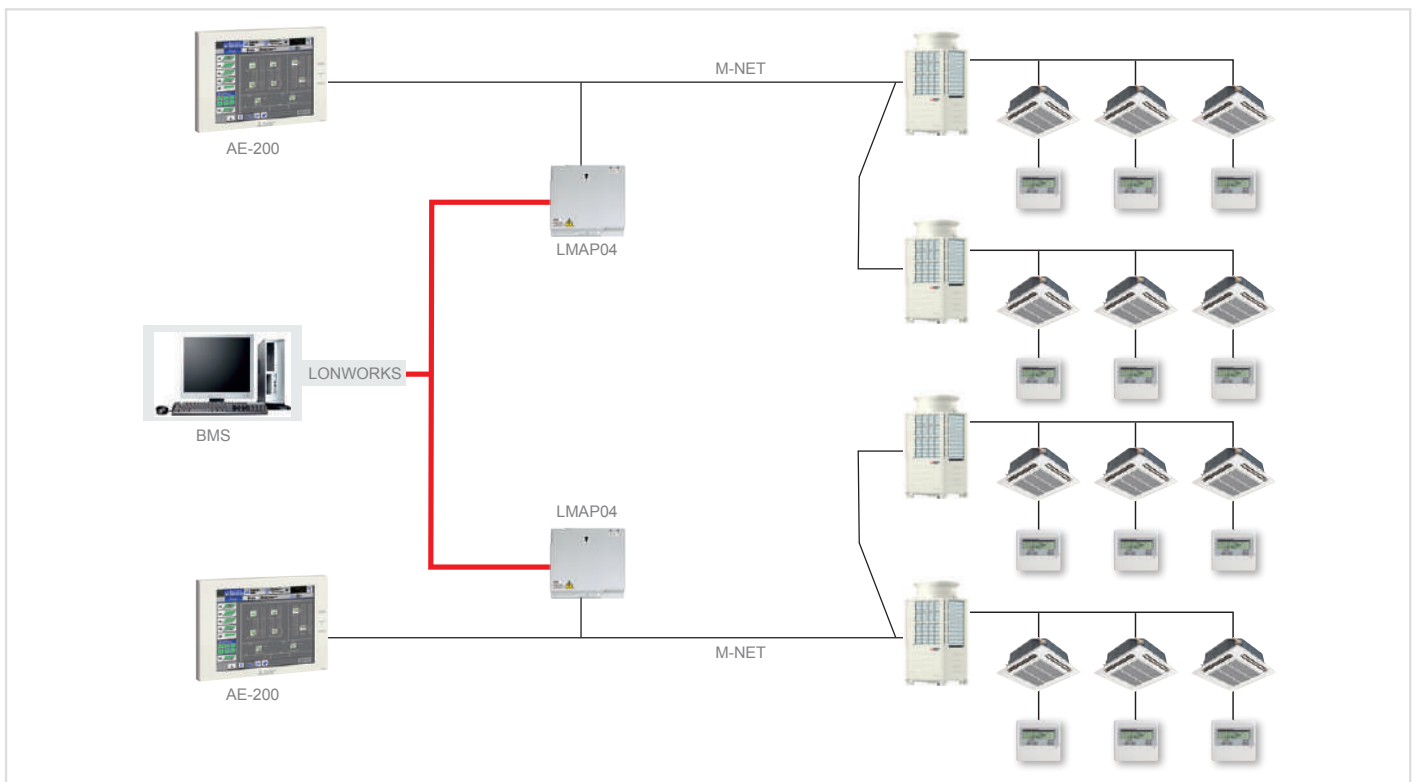

XML

BMS INTERFACE FOR ETHERNET NETWORKS

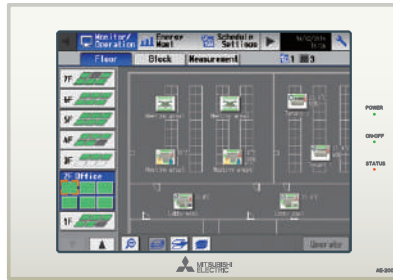

AE-200



EW-50

XML BMS interface for ethernet networks

XML is an innovative new communication system developed specifically for exchanging data over the web. XML makes it possible to create custom software extremely simply, which can even be used with a standard internet browser. The XML protocol makes it possible to integrate with a BMS system using the AE-200E or EW-50 WEB Server centralized controllers, with no additional dedicated hardware interfaces. As all the information necessary for the BMS system is available in XML

format directly over the Ethernet communication port of the AE-200E / EW-50 controller, all that needs to be done is to connect both the AE-200E / EW-50 WEB Server centralized controllers and the BMS computer system to the same network. Connecting to a BMS system with the XML protocol is extremely simple, as the Ethernet network platform is used. No dedicated conversion or interface hardware is needed, as shown in the typical layout schematic.

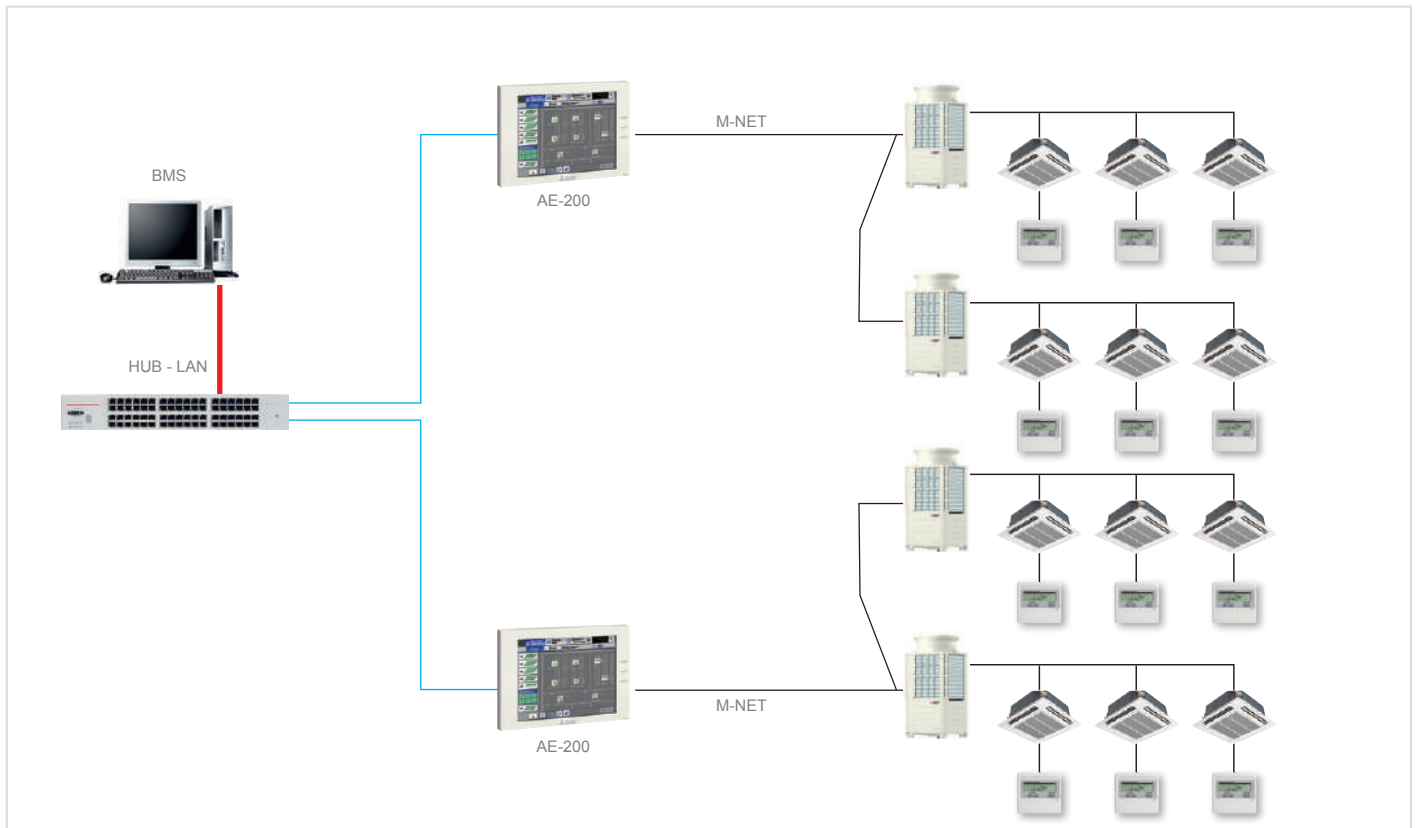

ME-AC-MBS-100

BMS INTERFACE FOR MODBUS® NETWORKS



ME-AC-MBS-100 – BMS interface for Modbus® networks

The Modbus communication protocol was initially used for PLC networks. Mitsubishi Electric offers an interface capable of controlling up to 100 indoor units (ME-AC-MBS-100) for managing a VRF CITY MULTI installation with a BMS system.

The interface is connected to the Modbus supervisor system either by an RS232/RS485 serial connection or a TCP/IP over Ethernet connection, and is connected to the Mitsubishi Electric VRF CITY MULTI installation by Ethernet.



ME-AC-KNX-100

BMS INTERFACE FOR KNX® NETWORKS



ME-AC-KNX-100 – BMS interface for KNX® networks

KNX is one of the global standards for automated household and building control. This open protocol ensures cross-compatibility between products from different manufacturers. Mitsubishi Electric offers an interface capable of controlling up to 100 indoor units (ME AC KNX – 100) for

managing a VRF CITY MULTI installation with a BMS system. The interface is connected directly to the EIB bus linked to the KNX network, and to the Mitsubishi Electric VRF CITY MULTI installation by Ethernet.

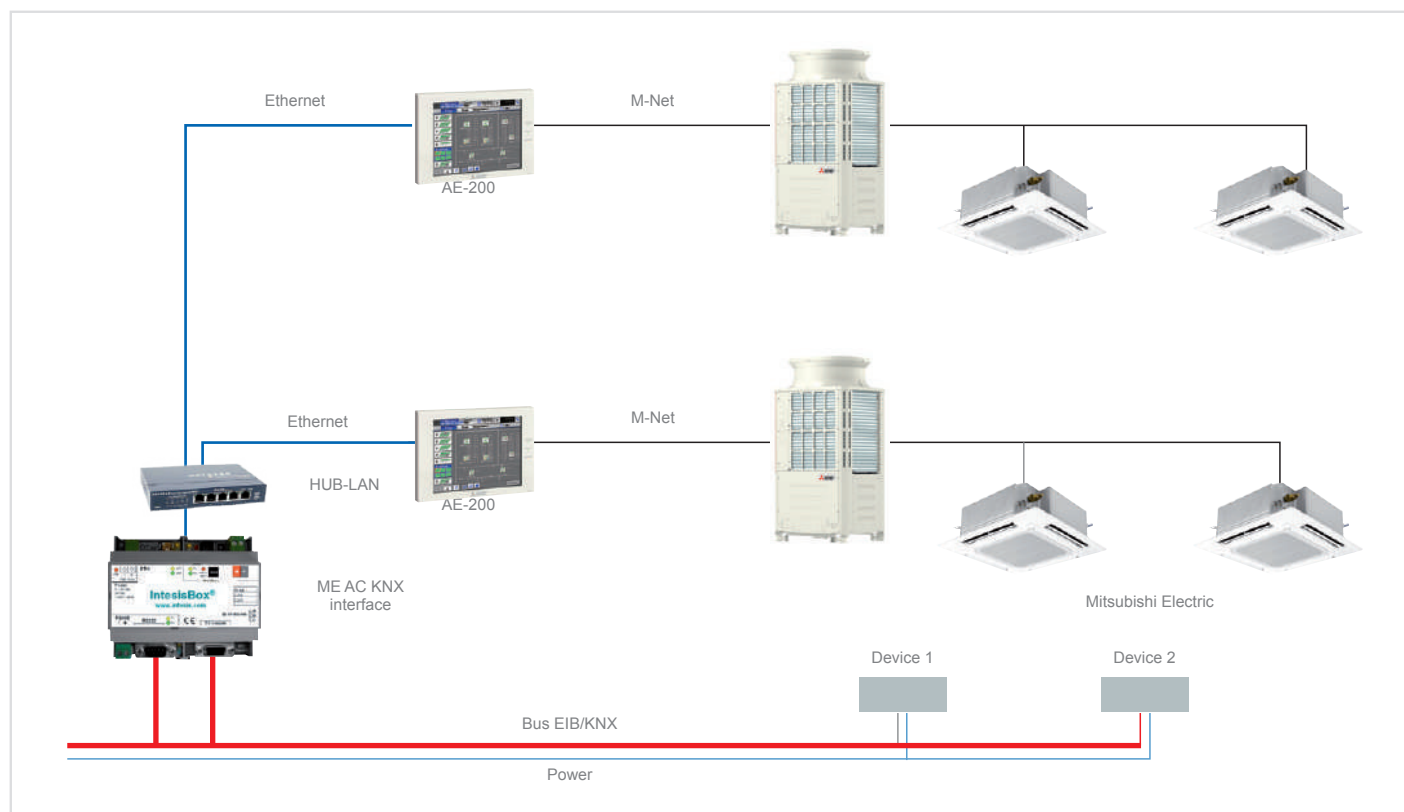

BACnet® PIN CODE

BMS INTERFACE FOR BACNET® NETWORKS

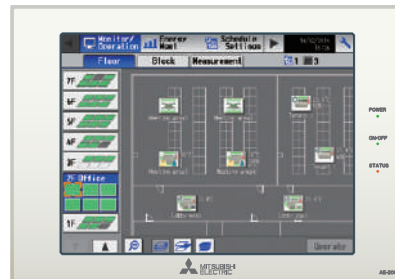

BACnet® PIN code

The BACnet® protocol was originally developed by ASHRAE in North America specifically for HVAC applications (Heat, Ventilation, Air Conditioning). It was subsequently also adopted in Europe as one of the standard communication solutions for air conditioning systems, together with LonWorks® and other protocols. One of the greatest advantages of this protocol is the extraordinary degree of cross-compatibility it offers, allowing systems from different manufacturers to be integrated with each other. New BACnet PIN code allows communication between Mitsubishi Electric system and BACnet BMS network with the same monitoring

information and settings which were available with BAC-HD150. **BACnet PIN code is available only for WEB Server 3D centralized controls (AE-200, EW-50).** Physical connection is via Ethernet cable through a dedicated port on centralized control. Thanks to new BACnet PIN code it is possible to remove one hardware component (BAC-HD150) from the system, simplifying its structure and removing one potential source of malfunction. Each centralized control equipped with BACnet PIN code is able to handle up to 50 indoor units and 50 groups.

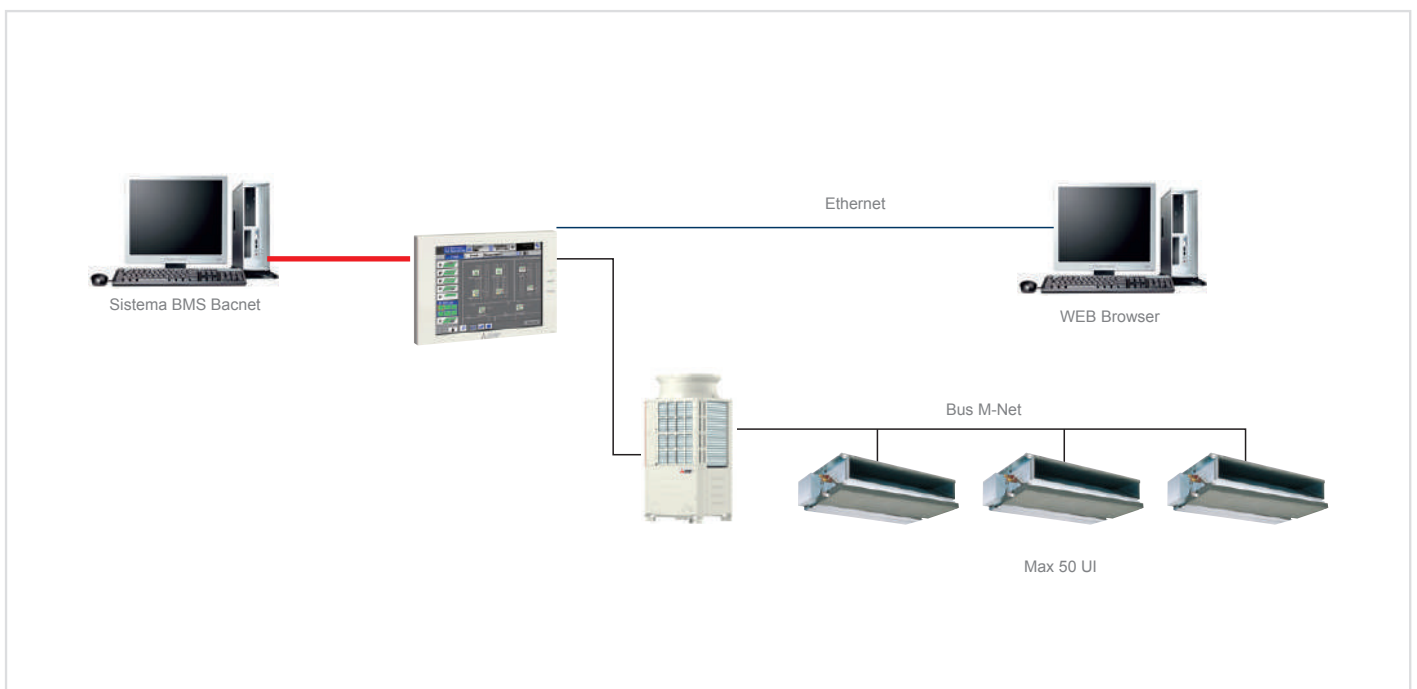

Modular Chiller

e-Series

Modular Chiller	294
P900	300
P1500/1800	312
M1500/1800	 324





Modular chiller

NEW

e-series

R32

The e-series chiller allows for up to six individual units to be connected together. Available as a cooling only or heat pump version, the e-series is suitable for both comfort and process cooling applications.

Mitsubishi Electric's modular chiller line-up contributes to realizing high functionality, reliability and energy saving with its own control.

Three capacity modules with the side flow type of 30 HP, the top flow type of 50, 60 HP

Both the 50HP and 60HP models are available in two different refrigerant version, the traditional one R410A, and the new low GWP solution R32



A new generation of chiller technology

Mitsubishi Electric is the first name for comfort and efficiency.

Founded in 1921, Mitsubishi Electric is now a global, market leading environmental technologies manufacturer. In the worldwide market, the Living Environment Systems Division provides pioneering solutions that heat, cool, ventilate and control our buildings in some of the most energy efficient ways possible.

Through our technical expertise, long experience and innovative product range, we enable building operators everywhere to significantly improve energy efficiency, reduce running costs and adhere to increasingly tough legislation. We believe that global climate challenges need local solutions. There are number of challenges facing building owners and managers today, they must tackle ongoing requirements to reduce energy used in their buildings and their running costs, and our aim is to help them in achieving these goals.

At Mitsubishi Electric, we have evolved and today we offer advanced technology that really can make a world of difference. permettono la classificazione in **classe A+++ sia in raffrescamento che in riscaldamento.**

Why chillers?

Today's building owners and managers face the challenge of providing a comfortable, productive space that is also energy efficient.

As the drive to reduce energy waste continues with further legislation, building services are being scrutinised to find more ways to optimise performance. Air conditioning is acknowledged as a significant energy user in buildings, therefore chillers can make a significant impact on the energy performance and running cost for many buildings. As manufacturers, we are being tasked with producing more efficient equipment and with enabling specifiers to compare products easily with regard to efficiency and performance.

In Commercial buildings HVAC accounts for 45% of total energy consumption

In commercial buildings, HVAC is by far the most energy intensive system, accounting for close to half of the total energy consumption. For this reason every efficiency improvement in HVAC performance can significantly reduce the energy profile of the building, turning HVAC optimisation into a value generating opportunity.

ErP Directive - Lot 21

The main impact of the ErP (Energy Related Products) Lot 21 will be on the way that chiller efficiency is measured. Ratings will be based on higher requirements for seasonal efficiency, and many older existing chillers will not comply. The ErP uses different performance parameters for different types of product to set the Minimum Energy Performance Standards (MEPS).

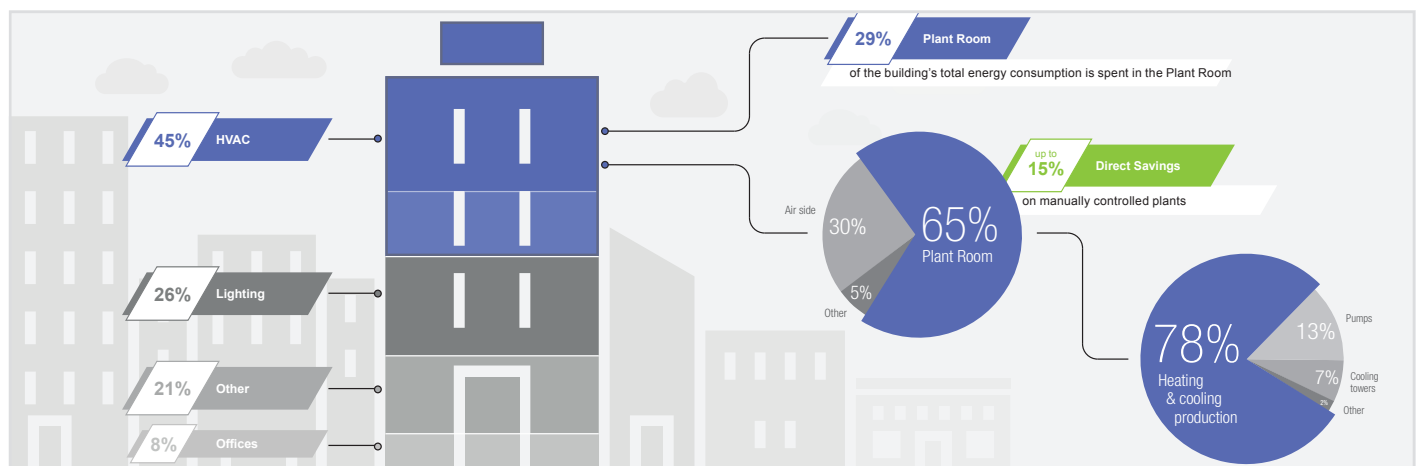

Source	Cooling Capacity	Minimum Efficiency	
		Jan 2018	Jan 2021
Air Cooled	<400kW	149%	161%
Air Cooled	≥400kW	161%	179%
Water Cooled	<400kW	196%	200%
Water Cooled	≥400kW ≤1500kW	227%	252%
Water Cooled	≥1500kW	245%	272%

The latest chiller technologies help to address the ERP Directive by ensuring that they operate to meet the precise cooling demand of the building, conserving energy usage within the building. The main components of water and air cooled chillers are very similar.

The way we use buildings today is changing, and the energy demands are changing with them. So now is a good time to consider the benefits of upgrading chiller plant.

With legislation pushing buildings towards greater energy efficiency and reducing carbon, and new regulations bringing even more efficient chiller options, such as heat recovery, to the market, specifiers have every reason to take a look at the benefits of a modern chiller for both new construction and retrofit scenarios.

The impact of a chiller on the comfort of occupants should also be considered. With a modern, robust technology in place, building owners can be assured that they are providing a comfortable and healthy environment, as well as saving themselves energy costs in the long-term.

Best in class efficiency for energy saving performance by the use of inverter compressors

- Inverter compressor is automatically controlled according the load.
- Optimal control of fans by using inverters contributes to save energy.

High functionality of modular chiller

- Up to 6 modules can be connected.
- The combination control of modules helps to continue operation even when one module has stopped due to maintenance.

Saving space and installation work

- Small footprint installation helps to save space.
- Built-in header type is optional, external piping space can be reduced.

Easy system control



- Water temperature can be controlled remotely by using local remote controllers.
- By installing an AE-200E/A, it is possible to centrally control e-series and CITY MULTI at the same time.



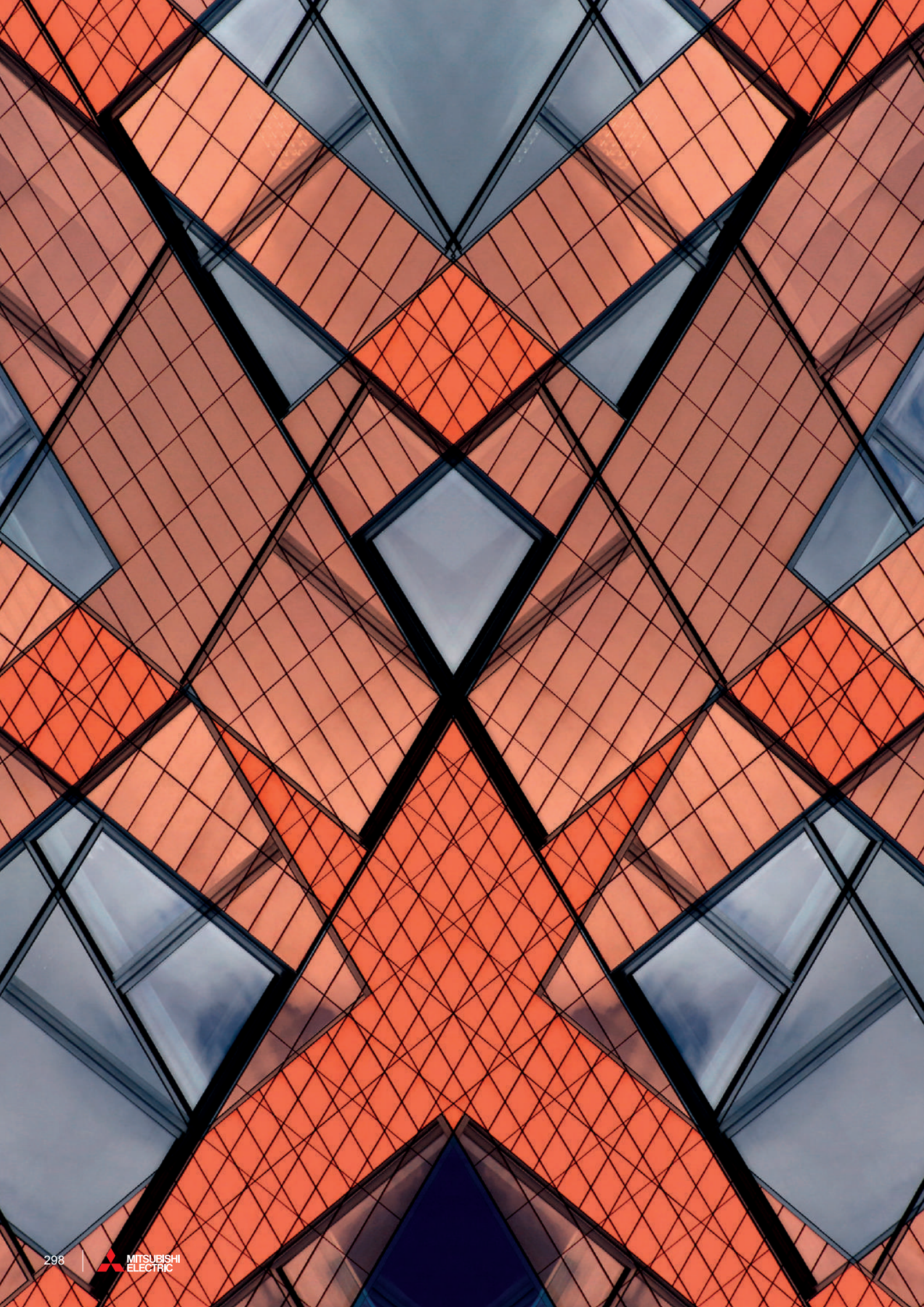



Module line-up

	90kW module*1	150kW module	180kW module
			
Heat Pump	EAHV-P900YAL(-N)(-BS)	EAHV-P1500YBL(-N)(-BS)	EAHV-P1800YBL(-N)(-BS)
	EAHV-P900YAF(-N)(-BS)	EAHV-M1500YCL(-N)(-BS) R32 NEW	EAHV-M1800YCL(-N)(-BS) R32 NEW
Heating Only	EAHV-P900YAL-H(-N)(-BS)	EAHV-P1500YBL-H(-N)(-BS)	EAHV-P1800YBL-H(-N)(-BS)
	EAHV-P900YAF-H(-N)(-BS)		
Cooling Only	EACV-P900YAL(-N)(-BS)	EACV-P1500YBL(-N)(-BS)	EACV-P1800YBL(-N)(-BS)
	EACV-P900YAF(-N)(-BS)	EACV-M1500YCL(-N)(-BS) R32 NEW	EACV-M1800YCL(-N)(-BS) R32 NEW

* (-N) indicates model with built-in header.

*1 The amount of pre-charged refrigerant differs among models. YAF indicates full refrigerant charging model.

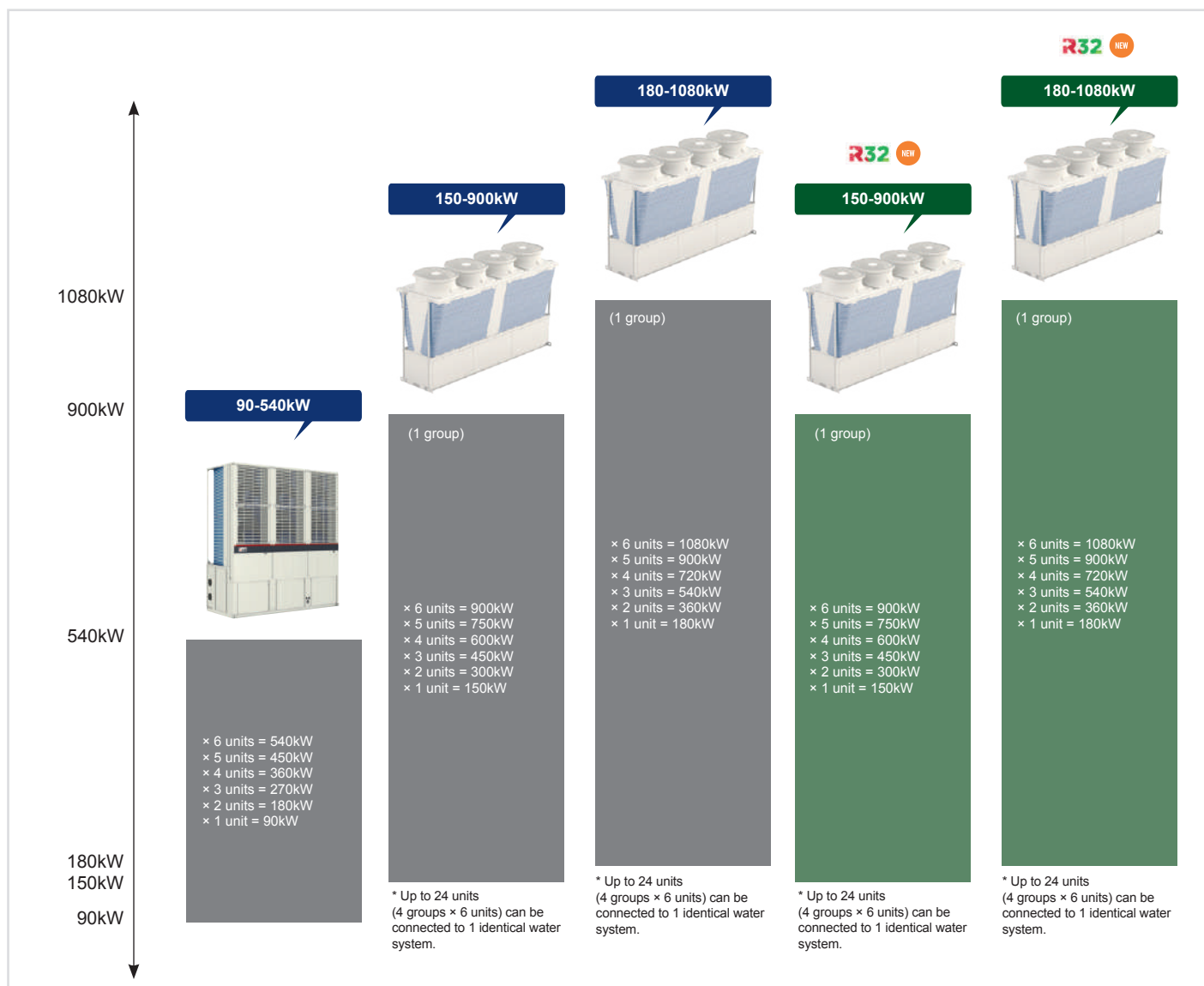

P900

R410A

e-series

HIGH ENERGY SAVING
PERFORMANCE BY
THE USE OF INVERTER
COMPRESSORS

BEST IN CLASS
EFFICIENCY FOR ENERGY
SAVING PERFORMANCE

ENERGY-SAVING
TECHNOLOGY



UP TO 6 MODULES
CAN BE CONNECTED

COMBINATION
CONTROL FUNCTION

High energy saving performance by the use of inverter compressors

Each module is provided with two high-efficiency inverter scroll compressors developed by Mitsubishi Electric and can operate optimally according to the load. This improves the high energy saving performance.

Best in class efficiency for energy saving performance

High EER, High COP

- The air suction area is expanded to maximize the performance of the air heat exchanger.
- Two independent refrigerant circuits are provided in the module to cool and heat water in two stages in series to improve EER and COP.

EER 3.30

COP 3.50

*EER shows the value at an outdoor air temperature of 35°C and cool water inlet/outlet temperatures of 12°C/7°C, respectively. COP shows the value at an outdoor air temperature of 7°C and hot water inlet/outlet temperatures of 40°C/45°C, respectively. Pump input is not included.

High SEER

- Achieved the same SEER from 30 to 180 HP.

SEER 4.48

* SEER shows the value at an outdoor air temperature of 35°C and cool water inlet/outlet temperatures of 12°C/7°C, respectively. Pump input is included based on EN14511.

Suppression of heating capacity drop at low outside temperatures

- A heat pump technology captures heat from the outdoor air. The heating performance decrease which occurs with a decrease in outdoor air temperature has been made up for by installing a larger number of units. This disadvantage has been eliminated with the e-series by increasing the heating performance in the low outdoor air temperature range. This allows the user to reduce the required number of units.

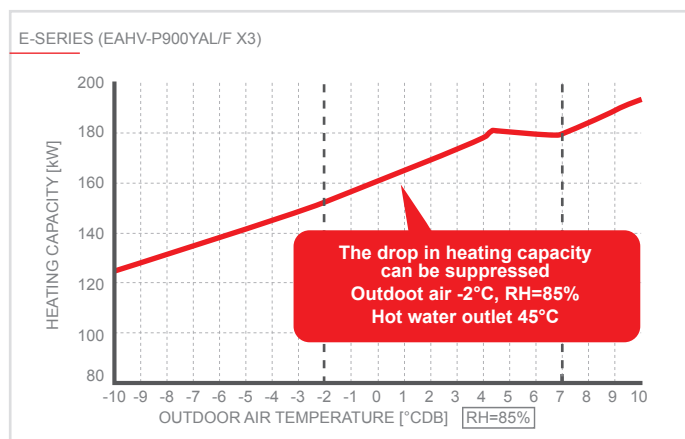

Energy-saving technology

High Efficiency Inverter Compressor

DC inverter scroll compressor is incorporated. Two compressors each are incorporated to increase efficiency.

Two refrigerating cycles

A configuration of two independent refrigerant circuits and the series connection of water-side heat exchangers increase the performance (two-stage cooling).

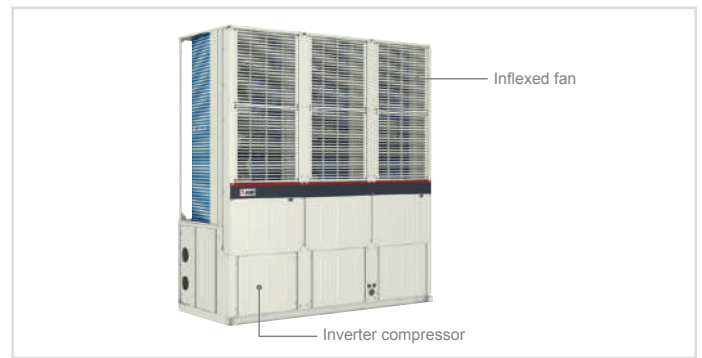

U-shaped High Performance Compact Air Heat Exchanger

U-shaped air heat exchangers are used. Installing them in a row makes the system thinner.

Weather resistant coating is provided for the heat transfer plate fin as standard.

Inflexed Fan

Adoption of a fan with improved ventilation characteristics and a newly designed trailing edge that suppresses wind turbulence raises fan operation efficiency.

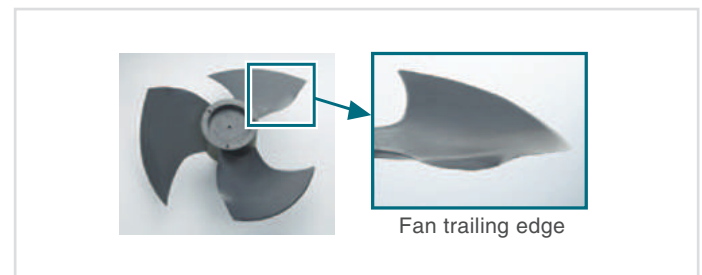

Fan Inverter Control

Air blower fans are also equipped with an inverter to save energy.

Up to 6 modules can be connected

The total capacity can be increased to up to 30HP × 6 modules = 180HP. Because modules can be installed horizontally in a row. Installation in narrow places such as along building walls is possible.

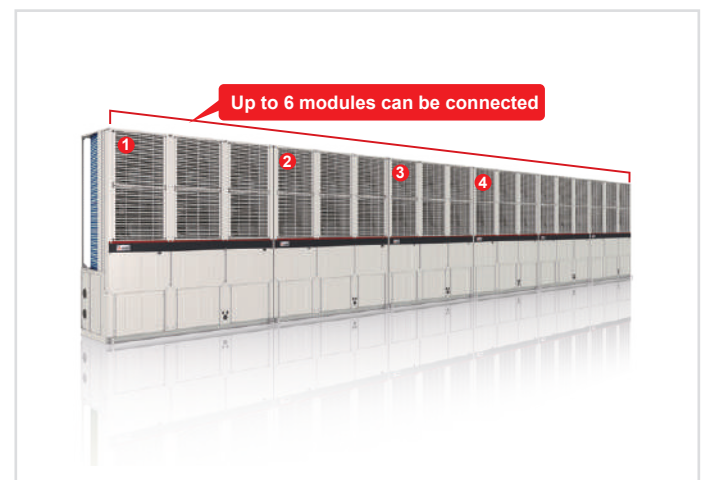

Combination control function

The flexible backup operation among the combined modules enables the continuous operation, even when one module is stopped due to maintenance.

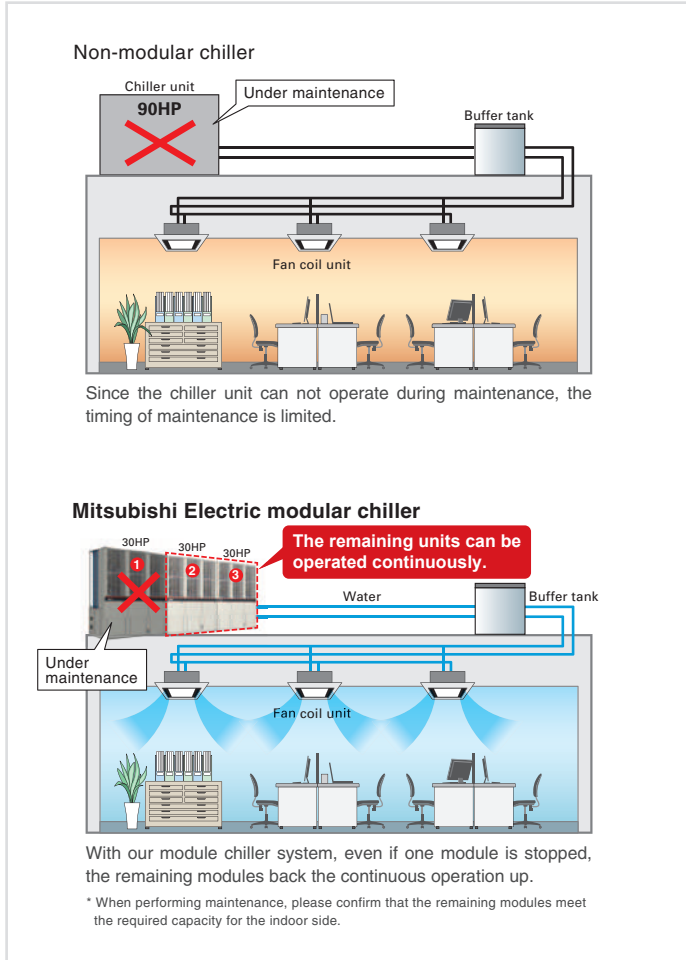

Small footprint installation

Since this module has a compact and thin body, it is suitable for installation along the exterior walls of buildings or in narrow spaces, and it is possible to install the modules on each floor.



Installation example

Installable in limited space, such as along the outer wall or in the corner of a factory, or in a narrow space of a building. The compact and thin design allows for the consideration of installation on each floor of a building, as is the case with industrial air conditioners. (If the inside header specification is selected).

The figure shows the air blowing surface directed toward the wall (a diagonal blowing air guide is equipped as standard). Directing the air blowing surface toward the wall is effective in preventing short cycling.

The modules can be installed in two rows or in one row on each of two stages using a frame. They can be installed flexibly according to the installation space.

EXAMPLE OF INSTALLATION ALONG THE OUTER WALL OF A FACTORY

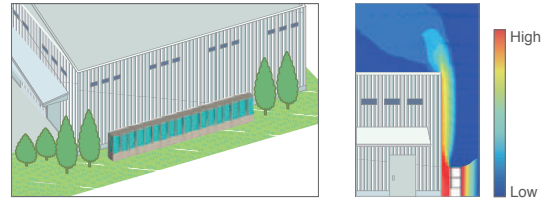

FRONT SURFACE-FACING DOUBLE-ROW INSTALLATION EXAMPLE

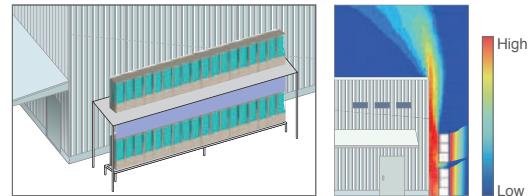

SINGLE-ROW DOUBLE-STACK INSTALLATION EXAMPLE

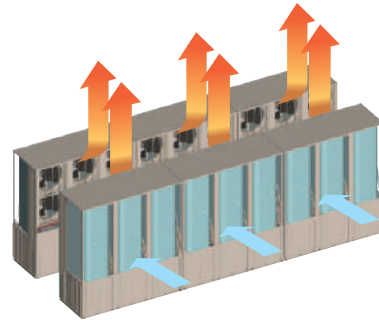



Inside Header

Mitsubishi Electric's Unique Inside Header Incorporates Field Water Pipe Header into Module

• The field water pipe header section that is usually required to connect the module to the field water pipe is now available as a manufacturer option (hereinafter referred to as the "inside header") which can be incorporated into the module at the factory before shipment (a supplied connection kit is used for the connection work at the customer's site).

• This allows for incorporating the field water pipe header section into the module.
 • In addition, the field connection work of the inside header is very simple. Significant simplification of the water pipe connection compared to the previous one has reduced the installation time.

Standard Pipe Specification

THE FIGURE SHOWS A 60 HP UNIT IN WHICH TWO 30 HP MODULES ARE CONNECTED

A coupling to connect with the pipe supplied by the customer is to be supplied at the customer's site.

Cool/hot water outlet
Cool/hot water inlet
Cool/hot water outlet
Cool/hot water inlet

FIELD WATER PIPE HEADER CONNECTION IMAGE *1
(in the case of installing one pump for each module)

6-module connection

- Number of pumps: 6
- Pipes connected at the site: 12 points

*1 Be sure to install a strainer (optional parts: YS-50A) near the chiller on the inlet side of the cool/hot water pipe to prevent the entry of foreign substances such as dirt and sand particles to the plate heat exchanger

Inside Header Specification

(Left or right connection can be selected for the water pipes)

THE FIGURE SHOWS A 60 HP UNIT IN WHICH TWO 30 HP MODULES ARE CONNECTED

Installation spacing of 10 mm between units is ensured by installing the units while contacting them with spacers.

Cool/hot water outlet
Cool/hot water inlet
Cool/hot water outlet
Cool/hot water inlet

A coupling to connect with the pipe supplied by the customer is to be supplied at the customer's site.

Inside header
Inside header

FIELD WATER PIPE HEADER CONNECTION IMAGE *1
(in the case of installing one pump for the system)

6-module connection

The pipe space for this area is not necessary compared with the standard pipe specification.

- Number of pumps: 1
- Pipes connected at the site: 2 points (10 internal connection points)

*1 Be sure to install a strainer near the chiller on the inlet side of the cool/hot water pipe to prevent the entry of foreign substances such as dirt and sand particles to the plate heat exchanger.

About Pipe Connection Kit

THIS FIGURE SHOWS 540 HP (EAHV-P900YAL/F-N×6) AS AN EXAMPLE.



A Victaulic coupling is used to connect with the pipe at the customer's site (to be supplied in the field).
*Straub couplings and short pipes are included for the inside header specification

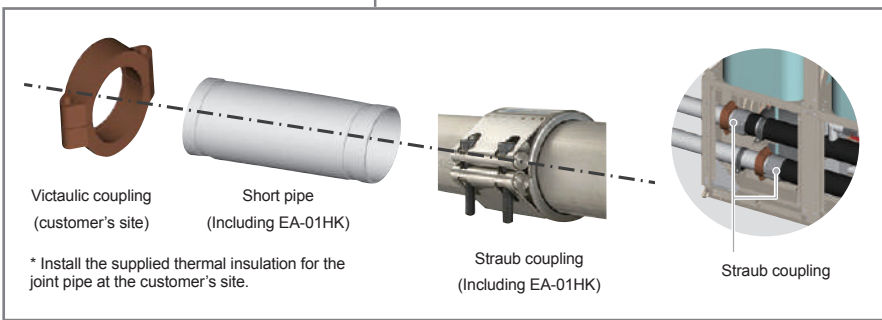

* Install the supplied thermal insulation for the joint pipe at the customer's site.

STRUCTURE

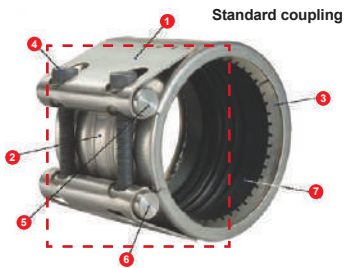

No.	Part name	Material
1	Casing	SUS 304
2	Sliding plate	SUS 301 or 304
3	Grip ring	SUS 301
4	Tightening bolt	SUS XM7
5	Rod washer	SUS 304
6	Rod nut	SUS 304
7	Rubber sleeve	EPDM

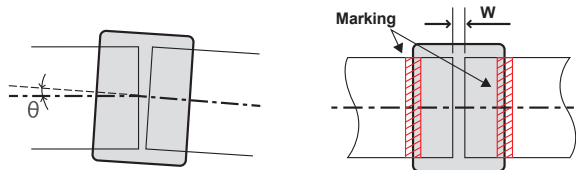

Allowable clearance and tilt range

Allowable pipe clearance value [W]=0 to 25 mm
Allowable pipe tilt angle [θ]=±2°

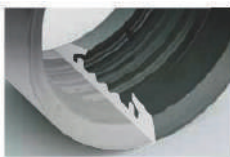

The sealed rubber has a lip structure to improve the water-stopping performance. Adjust the position of the Straub coupling so the marking on both sides can be seen.

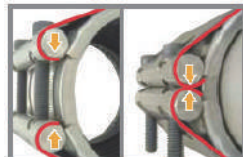

Just tighten the bolt until the casing fits against (comes into contact with) the metal. Anyone can connect the pipes evenly and securely, regardless of their skills and the type of the pipe used.

CONNECTING PIPE END (Connection at Customer's Site)

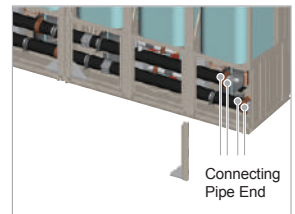
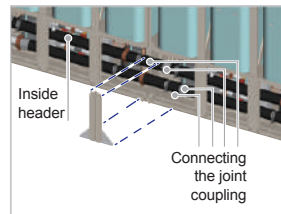

Capacity	Module (Inside header)	Optional parts -1- EA-01HK (model)	Optional parts -2- EA-02HK (model)
30 HP	1	1	0
60 HP (30 HP×2)	2	1	1
90 HP (30 HP×3)	3	1	2
120 HP (30 HP×4)	4	1	3
150 HP (30 HP×5)	5	1	4
180 HP (30 HP×6)	6	1	5

Optional parts -1- (Piping Kit) EA-01HK

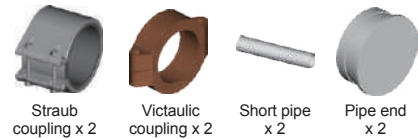

Optional parts -2- (Connection Piping Kit) EA-02HK



Optional parts -2-



The Victaulic coupling and Straub coupling mentioned in the explanation are product names.

Control technology

- Up to 6 modules and one unit can be connected for each remote control.
- Simultaneous control

Unit Remote Control

	
	PAR-W31MAA
Control	Simultaneous control
Number of modules that can be connected	6
Number of units that can be connected	1
Number of supported water lines	1
ON/OFF	•
Cooling/heating switch	•
FAN operation switch for snowfall	•
Target outlet temperature setting	•
Scheduled operation	•
Individual error display	•
Outlet water temperature setting of 5°C or below (Brine)	•

Centralized controller*

When connected to the AE-200E/A centralized controller or the EW-50A/E expansion controller, up to 6 e-series modules can be connected to 1 group for centralized monitoring and management. Combined management of CITY MULTI is also possible.

* Centralized monitoring and management are possible only for M-NET-connected e-series units.

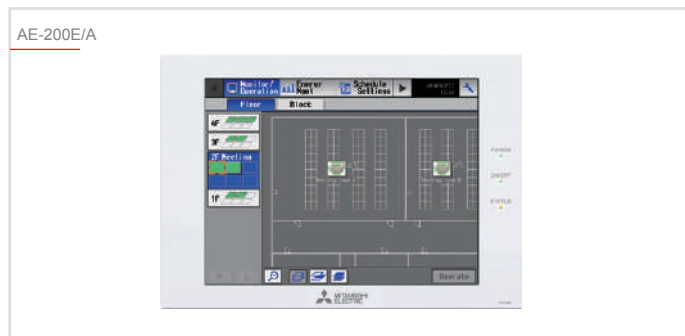

Monitoring on LCD touch panel and web browser

Monitoring of the operating condition—including the water temperature—of e-series units are possible from the LCD screen of the AE-200E/A or from a Web browser. Combined management of CITY MULTI is also possible.

System configuration

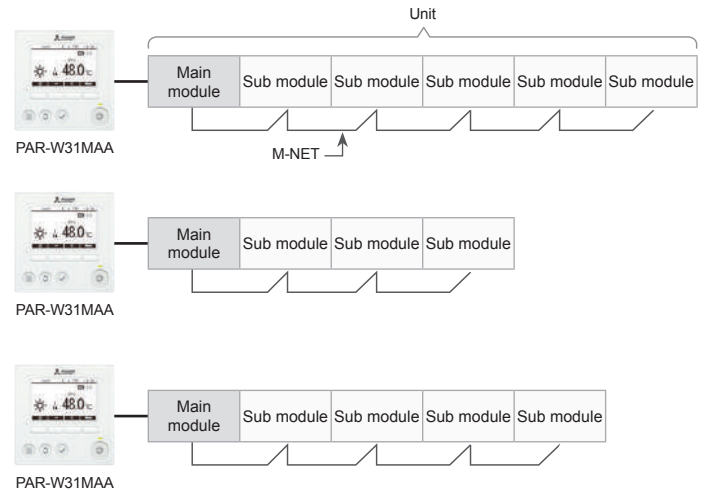

Demand control

Forced capacity control up to the demand upper limit by an external input to the unit (non-voltage normal open). Heating demand is possible in addition to the cooling demand.

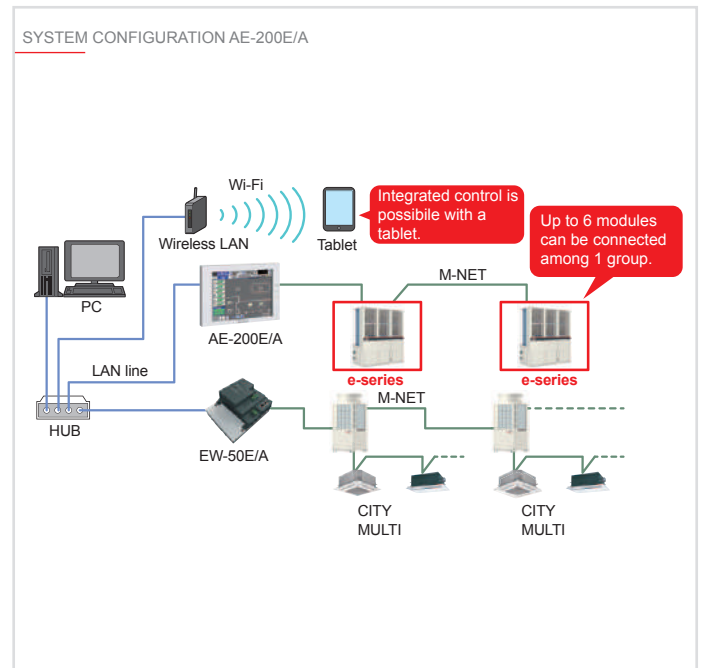

Technical specifications COOLING ONLY MODEL



MODEL		SET	EACV-P900YAL(-N)(-BS) EACV-P900YAF(-N)(-BS)	
Power source	3-phase 4-wire 380-400-415V 50/60Hz			
Capacity change mode			Capacity priority	COP priority
Cooling capacity *1 Water			kW	90.00
			kcal/h	77,400
			BTU/h	307,080
	Power input *2		kW	27.27
	Current input 380-400-415V		A	46.0 - 43.7 - 42.2
	Pump input is not included	EER		3.30
		ESEER		5.66
	Certified value by EUROVENT	EER *3		3.08
		ESEER *3 *4		4.71
	ESEER (Includes pump input based on EN14511) *3 *5			5.46
SEER (Includes pump input based on EN14511) *3			4.88	
IPLV *6		kW/kW	6.34	
Water flow rate		m³/h	15.5	
Cooling capacity *7 *8 Brine(ethylene glycol 35wt%)			kW	56.73
			kcal/h	48,788
			BTU/h	193,563
	Power input *2		kW	25.98
	Current input 380-400-415V		A	43.9 - 41.7 - 40.2
	EER(Pump input is not included)			2.18
	EER(Includes pump input based on EN14511) *3			2.10
	Brine flow rate		m³/h	11.5
Maximum current input		A	61	
Water pressure drop	Water *9		kPa	135
	Brine(ethylene glycol 35wt%) *8 *10		kPa	106
Temp range	Cooling		°C	Outlet water 5~25 *11
	Water		°F	Outlet water 41~77 *11
	Cooling		°C	Outlet brine -10~25 *8 *12
	Brine(ethylene glycol 35wt%)		°F	Outlet brine 14~77 *8 *12
	Outdoor		°C	-15~43 *11 *12
		°F	5~109.4 *11 *12	
Circulating water volume range		m³/h	7.7~25.8	
Sound pressure level (measured in anechoic room) at 1m *1		dB (A)	65	
Sound power level (measured in anechoic room) *1		dB (A)	77	
Diameter of water pipe (Standard piping)	Inlet		mm (in)	50A (2B) housing type joint
	Outlet		mm (in)	50A (2B) housing type joint
Diameter of water pipe (Inside header piping)	Inlet		mm (in)	100A (4B) housing type joint
	Outlet		mm (in)	100A (4B) housing type joint
External finish	Polyester powder coating steel plate			
External dimension HxWxD			mm	2450 x 2250 x 900
Net weight	Standard piping		kg (lbs)	957 (2110)
	Inside header piping		kg (lbs)	992 (2187)
Design pressure	R410A		MPa	4.15
	Water		MPa	1.0
Heat exchanger	Water side	Stainless steel plate and copper brazing		
	Air side	Plate fin and copper tube		
Compressor	Type	Inverter scroll hermetic compressor		
	Maker	MITSUBISHI ELECTRIC CORPORATION		
	Starting method	Inverter		
	Quantity	2		
	Motor output		kW	11.7 x 2
	Case heater		kW	0.045 x 2
	Lubricant	MEL32		
Fan	Air flow rate		m³/min	77 x 6
			L/s	1283 x 6
			cfm	2719 x 6
	Type, Quantity	Propeller fan x 6		
	Starting method	Inverter		
Motor output		kW	0.19 x 6	
Protection	High pressure protection	High pres.Sensor & High pres.Switch at 4.15MPa (601psi)		
	Inverter circuit	Over-heat protection, Over current protection		
	Compressor	Over-heat protection		

*1 Under normal cooling conditions at outdoor temp 35°CDB/24°CWB (95°FDB/75.2°FWB) outlet water temp 7°C (44.6°F) inlet water temp 12°C (53.6°F).
 *2 Pump input is not included.
 *3 Pump is not included in e-series.
 *4 EN14511 standard (2013) formula is applied to figure out this value in case of fixed flow rate operation (flow rate is fixed at any heat load)
 Pump input is included in cooling capacity for EER calculation. Condition of water inlet and outlet is fixed at inlet 12°C and outlet 7°C.
 *5 EN14511 standard (2013) formula is applied to figure out this value in case of variable flow rate operation (flow rate varies per heat load).
 Pump input is included in cooling capacity for EER calculation. Condition of water temperature : inlet water temperature varies due to fixed water flow rate and outlet is fixed at outlet 7°C.
 *6 Calculations according to standard performances (in accordance with AHRI 550-590).
 *7 Under normal cooling conditions at outdoor temp 35°CDB/24°CWB (95°FDB/75.2°FWB) outlet brine temp -5°C (23.0°F) inlet brine temp 0°C (32.0°F).
 *8 Set the dipswitch SW3-6 on both main and sub modules to ON.
 *9 Under normal cooling conditions capacity 90kW, water flow rate 15.5m³/h
 *10 Under normal cooling conditions capacity 56.73kW, brine flow rate 11.5m³/h
 *Please don't use the steel material for the water piping.
 *Please always make water circulate, or pull the circulation water out completely when not in use.
 *Please do not use groundwater or well water in direct.
 *The water circuit must be closed circuit.
 *Due to continuous improvement, the above specifications may be subject to change without notice.

Technical specifications HEATPUMP MODEL



MODEL		SET	EAHV-P900YAL(-N)(-BS) EAHV-P900YAF(-N)(-BS)	
Power source			3-phase 4-wire 380-400-415V 50/60Hz	
Capacity change mode			Capacity priority	COP priority
		kW	90.00	63.00
		kcal/h	77,400	54,180
		BTU/h	307,080	214,956
Power input *3		kW	27.27	16.27
Current input 380-400-415V		A	46.0 - 43.7 - 42.2	27.5 - 26.1 - 25.2
Cooling capacity *1	Pump input is not included	EER	3.30	3.87
		ESEER	5.66	-
	Certified value by EUROVENT	EER *4	2.94	3.76
		ESEER *4 *6	4.71	-
	ESEER (Includes pump input based on EN14511) *4 *7		5.46	-
	SEER (Includes pump input based on EN14511) *4		4.88	-
	IPLV *8	kW/kW	6.34	-
	Water flow rate	m ³ /h	15.5	10.8
Heating capacity *2			kW	90.00
			kcal/h	77,400
			BTU/h	307,080
	Power input *3		kW	25.71
	Current input 380-400-415V		A	43.4 - 41.2 - 39.7
	COP (Pump input is not included)		3.50	3.71
	COP (Includes pump input based on EN14511) *4		3.25	3.61
	SCOP (Reversible) Low/Medium (Includes pump input based on EN14511) *4		3.66/2.89	-
	Seasonal space heating energy efficiency class for medium-temperature application		A+	-
	Seasonal space heating energy efficiency class for low-temperature application		A+	-
	Water flow rate	m ³ /h	15.5	10.8
Maximum current input	A	61		
Water pressure drop *5	kPa	135	65	
Temp range	Cooling	°C	Outlet water 5~25 *9	
		°F	Outlet water 41~77 *9	
	Heating	°C	Outlet water 30~55 *9	
		°F	Outlet water 86~131 *9	
	Outdoor	°C	-15~43 *9	
	°F	5~109.4 *9		
Circulating water volume range	m ³ /h	7.7~25.8		
Sound pressure level (measured in anechoic room) at 1m *1	dB (A)	65	63	
Sound power level (measured in anechoic room) *1	dB (A)	77	75	
Diameter of water pipe (Standard piping)	Inlet	mm (in)	50A (2B) housing type joint	
	Outlet	mm (in)	50A (2B) housing type joint	
Diameter of water pipe (Inside header piping)	Inlet	mm (in)	100A (4B) housing type joint	
	Outlet	mm (in)	100A (4B) housing type joint	
External finish		Polyester powder coating steel plate		
External dimension HxWxD	mm	2450 x 2250 x 900		
Net weight	Standard piping	kg (lbs)	987 (2176)	
	Inside header piping	kg (lbs)	1022 (2253)	
Design pressure	R410A	MPa	4.15	
	Water	MPa	1.0	
Heat exchanger	Water side		Stainless steel plate and copper brazing	
	Air side		Plate fin and copper tube	
Compressor	Type		Inverter scroll hermetic compressor	
	Maker		MITSUBISHI ELECTRIC CORPORATION	
	Starting method		Inverter	
	Quantity		2	
	Motor output	kW	11.7 x 2	
	Case heater	kW	0.045 x 2	
	Lubricant		MEL32	
Fan	Air flow rate	m ³ /min	77 x 6	
		L/s	1283 x 6	
		cfm	2719 x 6	
	Type, Quantity		Propeller fan x 6	
	Starting method		Inverter	
Motor output	kW	0.19 x 6		
Protection	High pressure protection		High pres.Sensor & High pres.Switch at 4.15MPa (601psi)	
	Inverter circuit		Over-heat protection, Over current protection	
	Compressor		Over-heat protection	

*1 Under normal cooling conditions at outdoor temp 35°CDB/24°CWB (95°FDB/75.2°FWB) outlet water temp 7°C (44.6°F) inlet water temp 12°C (53.6°F).

*2 Under normal heating conditions at outdoor temp 7°CDB/6°CWB (44.6°FDB/42.8°FWB) outlet water temp 45°C (113°F) inlet water temp 40°C (104°F).

*3 Pump input is not included.

*4 Pump is not included in e-series.

*5 Under normal cooling or heating conditions capacity 90kW, water flow rate 15.5m³/h

*6 EN14511 standard (2013) formula is applied to figure out this value in case of fixed flow rate operation (flow rate is fixed at any heat load)

Pump input is included in cooling capacity for EER calculation. Condition of water inlet and outlet is fixed at inlet 12°C and outlet 7°C.

*7 EN14511 standard (2013) formula is applied to figure out this value in case of variable flow rate operation (flow rate varies per heat load). Pump input is included in cooling capacity for EER calculation.

Condition of water temperature : inlet water temperature varies due to fixed water flow rate and outlet is fixed at outlet 7°C.

*8 Calculations according to standard performances (in accordance with AHRI 550-590).

*Please don't use the steel material for the water piping.

*Please always make water circulate, or pull the circulation water out completely when not in use.

*Please do not use groundwater or well water in direct.

*The water circuit must be closed circuit.

*Due to continuous improvement, the above specifications may be subject to change without notice.

Technical specifications HEATING ONLY MODEL

MODEL		SET	EAHV-P900YAL-H(-N)(-BS) EAHV-P900YAF-H(-N)(-BS)	
Power source			3-phase 4-wire 380-400-415V 50/60Hz	
Capacity change mode			Capacity priority	COP priority
Heating capacity *1		kW	90.00	63.00
		kcal/h	77,400	54,180
		BTU/h	307,080	214,956
	Power input *2	kW	25.71	16.96
	Current input 380-400-415V	A	43.4 - 41.2 - 39.7	28.6 - 27.2 - 26.2
	COP (Pump input is not included)		3.50	3.71
	COP (Includes pump input based on EN14511) *3		3.25	3.61
	SCOP (Reversible) Low/Medium (Includes pump input based on EN14511) *4		3.56/2.83	-
	Seasonal space heating energy efficiency class for medium-temperature application		A+	-
	Seasonal space heating energy efficiency class for low-temperature application		A+	-
Water flow rate	m³/h	15.5	10.8	
Maximum current input	A		61	
Water pressure drop *5	kPa		135	65
Temp range	Heating	°C	Outlet water 30~55 *6	
		°F	Outlet water 86~131 *6	
	Outdoor	°C	-15~43 *6	
		°F	5~109.4 *6	
Circulating water volume range	m³/h		7.7~25.8	
Sound pressure level (measured in anechoic room) at 1m *4	dB (A)		65	63
Sound power level (measured in anechoic room) *4	dB (A)		77	75
Diameter of water pipe (Standard piping)	Inlet	mm (in)	50A (2B) housing type joint	
	Outlet	mm (in)	50A (2B) housing type joint	
Diameter of water pipe (Inside header piping)	Inlet	mm (in)	100A (4B) housing type joint	
	Outlet	mm (in)	100A (4B) housing type joint	
External finish	Polyester powder coating steel plate			
External dimension HxWxD	mm		2450 x 2250 x 900	
Net weight	Standard piping	kg (lbs)	987 (2176)	
	Inside header piping	kg (lbs)	1022 (2253)	
Design pressure	R410A	MPa	4.15	
	Water	MPa	1.0	
Heat exchanger	Water side	Stainless steel plate and copper brazing		
	Air side	Plate fin and copper tube		
Compressor	Type	Inverter scroll hermetic compressor		
	Maker	MITSUBISHI ELECTRIC CORPORATION		
	Starting method	Inverter		
	Quantity	2		
	Motor output	kW	11.7 x 2	
	Case heater	kW	0.045 x 2	
	Lubricant	MEL32		
Fan	Air flow rate	m³/min	77 x 6	
		L/s	1283 x 6	
		cfm	2719 x 6	
	Type, Quantity	Propeller fan x 6		
	Starting method	Inverter		
Motor output	kW	0.19 x 6		
Protection	High pressure protection	High pres. Sensor & High pres. Switch at 4.15MPa (601psi)		
	Inverter circuit	Over-heat protection, Over current protection		
	Compressor	Over-heat protection		

*1 Under normal heating conditions at outdoor temp 7°CDB/6°CWB (44.6°FDB/42.8°FWB) outlet water temp 45°C (113°F) inlet water temp 40°C (104°F).

*2 Pump input is not included.

*3 Pump is not included in e-series.

*4 Under normal heating conditions at outdoor temp 7°CDB/6°CWB (44.6°FDB/42.8°FWB) outlet water temp 45°C (113°F) inlet water temp 40°C (104°F).

*5 Under normal heating conditions capacity 90kW, water flow rate 15.5m³/h

*Please don't use the steel material for the water piping material.

*Please always make water circulate, or pull the circulation water out completely when not in use.

*Please do not use groundwater or well water in direct.

*The water circuit must be closed circuit.

*Due to continuous improvement, the above specifications may be subject to change without notice.

Operating limits

COOLING ONLY

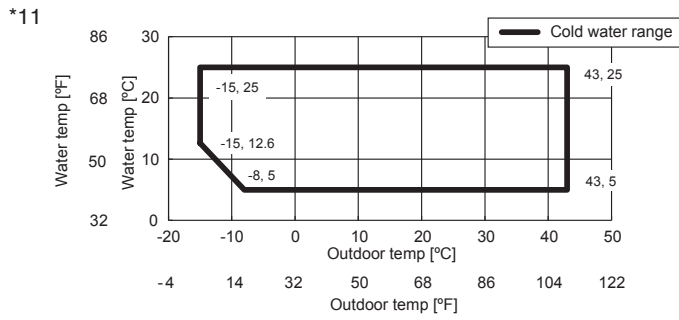

COOLING ONLY - BRINE MODE

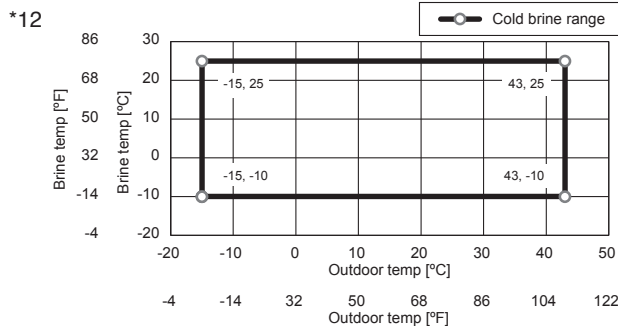

REVERSIBLE HEAT PUMP

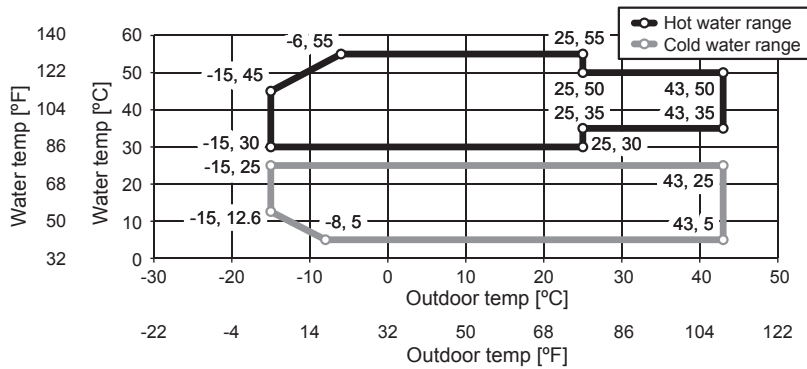

HEATING ONLY

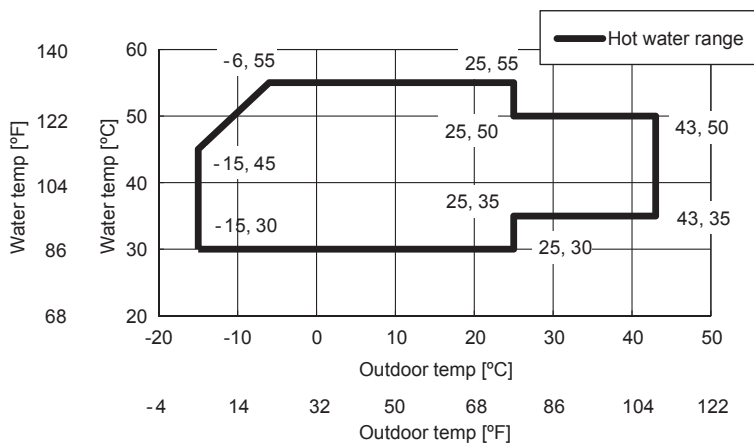

Unit converter	
kcal/h = kW x 860	
BTU/h = kW x 3,412	
lbs = kg/0.4536	
cfm = m ³ /min x 35.31	





P1500/P1800

R410A

e-series

KEY COMPONENTS
SAVE ENERGY

HIGH
FUNCTIONALITY
OF MODULAR
CHILLER

BEST IN CLASS
EFFICIENCY FOR
ENERGY SAVING
PERFORMANCE

OPTIMUM FREQUENCY
CONTROL

IMPROVED
REDUNDANCY &
RESILIENCE



High energy-saving performance thanks to high-performance inverter compressor and proprietary Y-shaped construction.

Best in class efficiency for energy saving performance

The rated and seasonal energy efficiency ratios have been increased to achieve high energy saving performance.

Rated efficiency

The use of the high-efficiency inverter compressors achieves high energy saving performance. The 50 HP model has cooling EER and heating COP rating corresponding to energy saving class A.

Model P1500
EER 3.19*1

Model P1500
COP 3.29*2

*1 Under normal cooling conditions at outdoor temp 35°DB/24°WB(95°FDB/75.2°FWB) outlet water temp 7°C(44.6°F) inlet water temp 12°C(53.6°F). Pump input is included in cooling capacity and power input based on EN14511.

*2 Under normal heating conditions at outdoor temp 7°DB/6°WB(44.6°FDB/42.8°FWB) outlet water temp 45°C(113°F) inlet water temp 40°C(104°F). Pump input is included in heating capacity and power input based on EN14511.

Seasonal efficiency

The use of the high-efficiency inverter compressors ensures optimum operation according to the operation load. The compressors can operate efficiently even during nighttime and intermediate seasons with low load, thereby saving energy throughout the year.

Model P1500
SEER 4.62*1

Model P1800
SEER 4.58*1

*1 Compliant with EN14511

Key components save energy

By controlling the frequency of the inverter compressors, the rated efficiency and the seasonal efficiency are higher. This achieves optimum energy saving according to the operation load.

Equipped with high-efficiency inverter compressors

Each unit is equipped with four high-efficiency inverter compressors, developed by Mitsubishi Electric. The four compressors operate as two pairs. The inverters observe the load and control the compressors so that they can optimally operate in one unit. The compressors use the IH warmer method. Heat is generated by the magnetic material characteristics of the motor core unit to prevent liquid refrigerant from remaining in the compressor when the unit stops. This reduces standby power compared to the crankcase heater method when the unit is stopped.

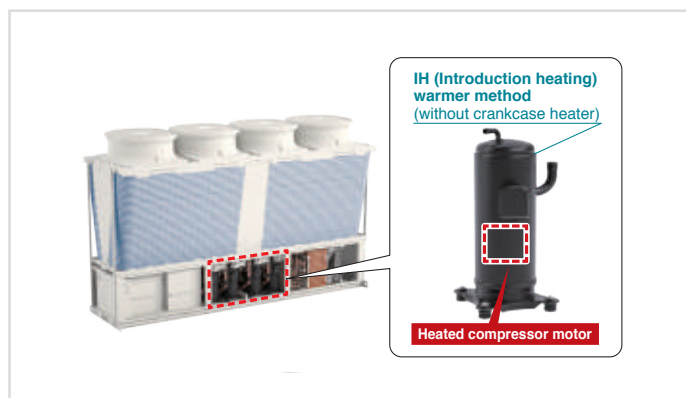

Use of Y-shape structure for effective operation

When the modules are connected, the intake air passages can be ensured on the floor and sides. This structure contributes to effective operation.



High functionality of modular chiller

The capacity among 1 group can be increased to up to 360 HP by combining units.

Large-capacity 50 HP and 60 HP units are available. Even a 360 HP system using six 60 HP units can be installed in a floor area of 8.53 m × 5.2 m including the service space

* Only modules with the same capacity can be combined.



Heat Pump	EAHV-P1500YBL(-N)
Heating Only	EAHV-P1500YBL-H(-N)
Cooling Only	EACV-P1500YBL(-N)

Heat Pump	EAHV-P1800YBL(-N)
Heating Only	EAHV-P1800YBL-H(-N)
Cooling Only	EACV-P1800YBL(-N)

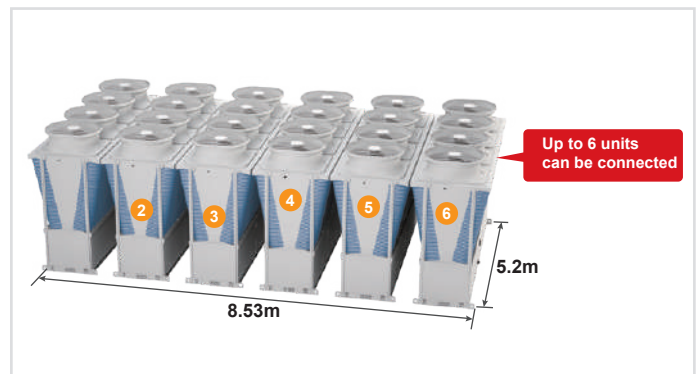

Optimum frequency control

When multiple modules are connected, the frequency of each inverter compressor is controlled during operation to increase the efficiency of each module, achieving a high energy saving performance.

This control can be implemented by simply using our unique M-NET control, without the need for any other on-site design.

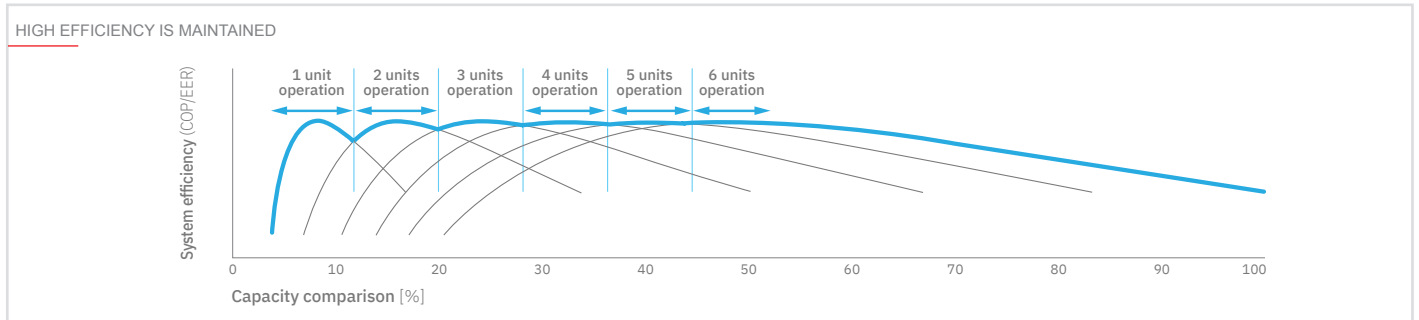

WHEN THE OVERALL SYSTEM LOAD IS 60%

Without optimum frequency control

100% 100% 100% 0% 0%

With non-inverter compressors, it is only possible to turn the unit on or off, and the compressor frequency cannot be adjusted according to the required capacity.

With optimum frequency control

60% 60% 60% 60% 60% 60%

Our modules are equipped with inverter compressors, so the system can be operated in frequency ranges in which the efficiency of each module is at its peak. Optimum frequency control of each unit increases the efficiency of the whole system.

WHEN THE OVERALL SYSTEM LOAD IS 20%

Without optimum frequency control

100% 0% 0% 0% 0%

Since the compressors are running at inefficient frequencies, the efficiency of the whole system is lower.

With optimum frequency control

60% 60% 0% 0% 0% 0%

Peak efficiency is between 40 and 60%. In low load conditions, modules can be switched off to **keep remaining modules at optimum efficiency.** The output of the pumps connected to the remaining group can be decreased, and the efficiency of the whole system is then increased. This control is achieved by connecting to M-NET. There is no need to prepare sensors, and the instrumentation is simple.

Improved redundancy & resilience

When a non-modular chiller is used as the main 300kW unit, as in this example, the same capacity would also be required as a backup. However, when a Mitsubishi Electric e-series modular chiller is used, two modules can still operate even if one module goes down, continuing normal operation. This reduces the backup capacity requirement.

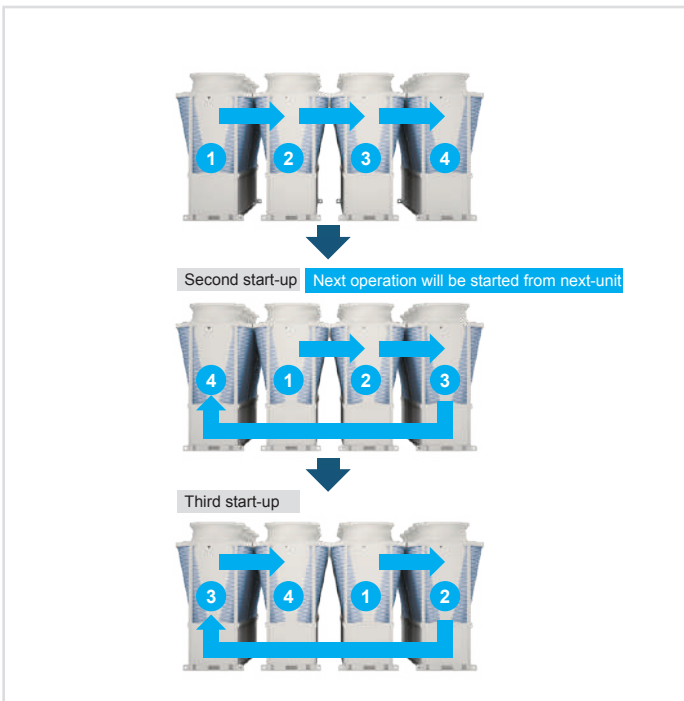
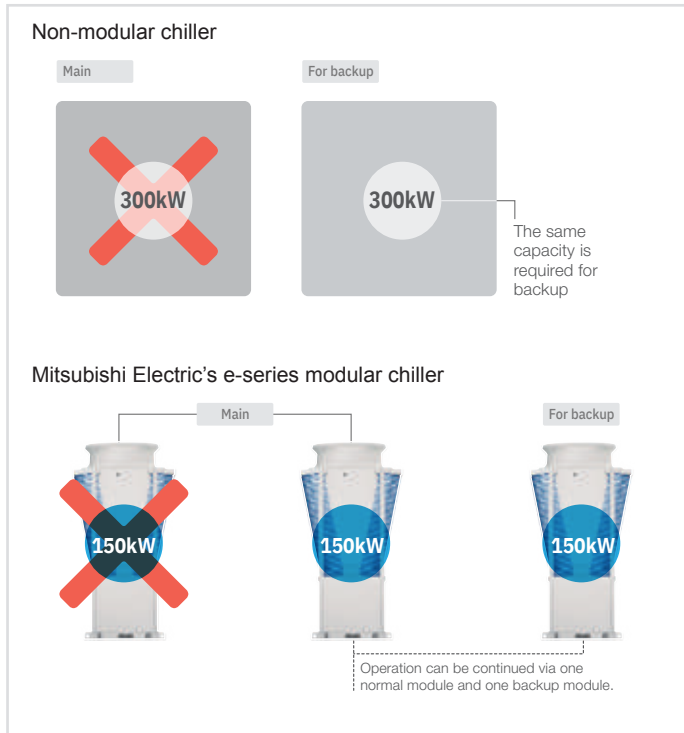

Emergency operation mode

When a single module

The e-series module contains four compressors (two for the 90kW module) developed by Mitsubishi Electric. The four compressors operate as two pairs. If something is wrong with one of the two pairs, the other pair can temporarily continue to operate. The 90kW module achieves this by operating its two compressors independently.

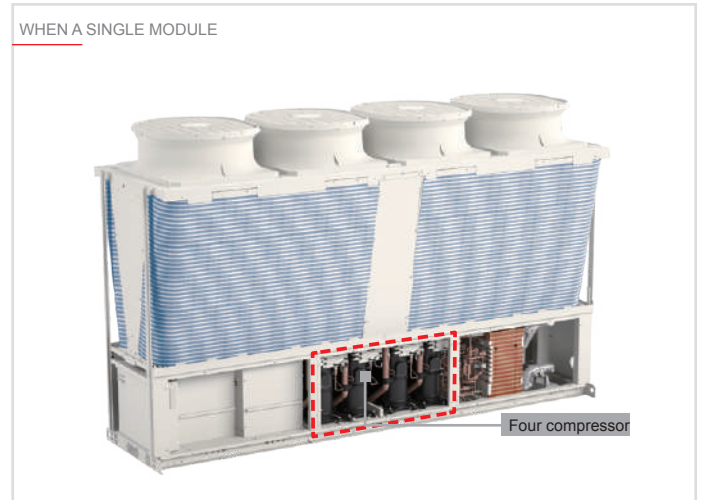

When multiple modules

If one of the e-series modules goes down, the remaining modules can continue to operate. Each module can independently control the outlet water temperature. Even if the main module goes down, operation can be continued.

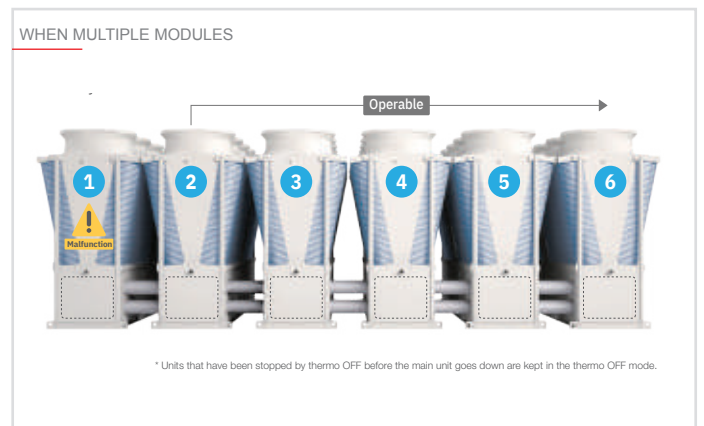

Procedure for installing the connection kit

Selectable piping system

Standard piping and built-in header types are available. The optimum type can be selected according to the design and construction needs of the building.

STANDARD PIPING TYPE	BUILT-IN HEADER TYPE (models with "-N" in the name only)
Type without built-in pump or header	Type of built-in header piping for connection between modules
Advantages The flexibility of design is high, and it is possible to select the most suitable number of pumps and water circuit for the on-site system.	Advantages The piping space and number of connections are reduced, allowing simple construction and short construction times. Advantages * It is not possible to build both the pump and the header in each unit.

Standard piping type

The flexibility of design is high, and the system can be designed according to the on-site system and load pattern. Up to 24 units (4 groups × 6 units) can be connected to one system. The number of pumps and the piping structure can be designed according to the on-site.

STANDARD PIPING TYPE	

Built-in header type

The piping to connect to other units is built into each unit. The number of piping connections is reduced (saving construction work and reducing the construction time), and the installation space can be also reduced.

BUILT-IN HEADER TYPE	
SPACE FOR RETURN PIPING IS NOT REQUIRED	

Details of built-in header type modules

Up to six units with built-in headers can be connected. (Piping size: 150A)
 When 6 units or a less are connected, flow adjustment and reverse return piping for each unit are unnecessary.

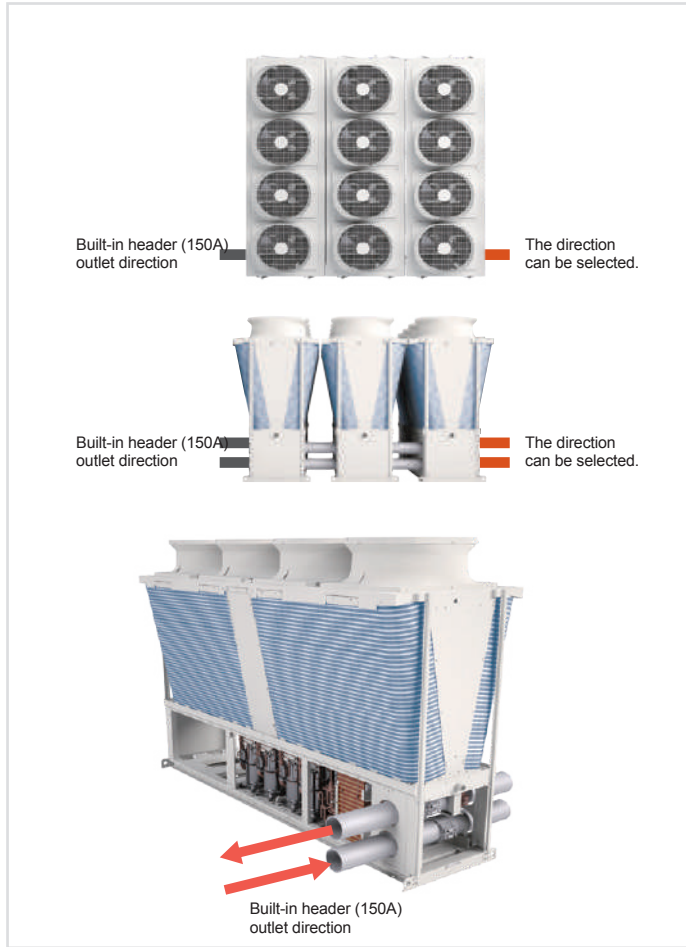

INSTALLATION OF PANELS

1 Install the panels on the end unit.

*Note: install panel S and then the closing panel.

2 Install panel B.

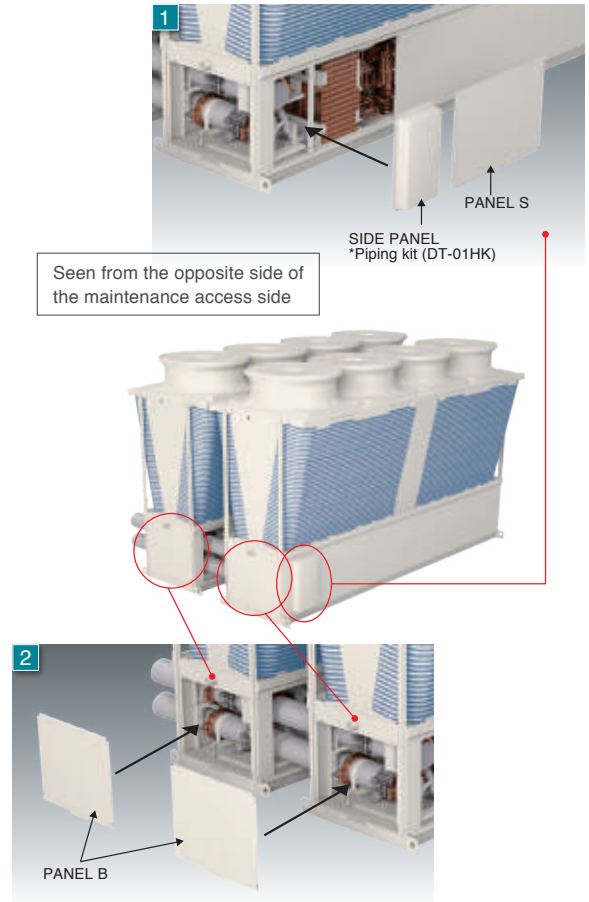

INSTALLATION OF END CONNECTION KIT (DT-01HK, EXCLUDING PANELS)

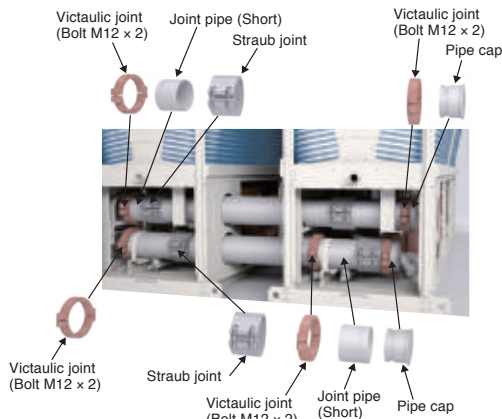

Optional parts ① (Piping Kit)
 DT-01HK

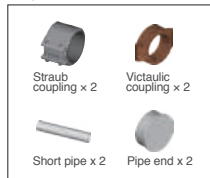

INSTALLATION OF CONNECTION KIT (DT-02HK, EXCLUDING PANELS)

* Please remove the panels before installing the connection kit.

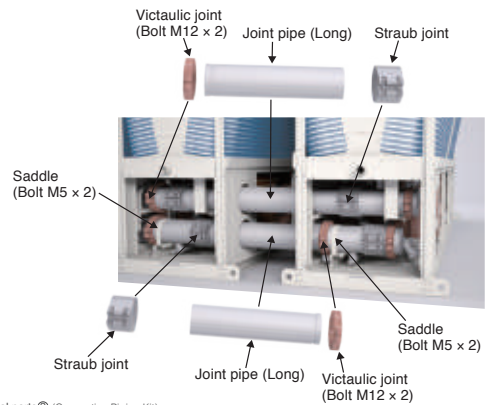

Optional parts ② (Connection Piping Kit)
 DT-02HK

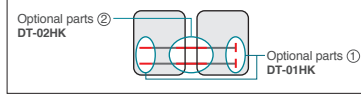
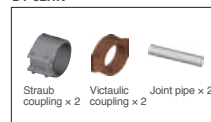

Control technology

You can perform basic operations, such as starting, stopping, mode switching, water temperature setting and schedule setting, by connecting a remote controller.



Operation/setting	ON/OFF
	Cooling/Heating/HeatingECO/Anti-freeze
	Snow/regular
	Demand
	Scheduled operation (daily/weekly)
Display	Operation mode
	Current water temperature
	Error code
Control function (function of chiller body)	Control of number of units Control to prevent simultaneous defrosting

External signal input

Basic operations, such as starting, stopping, mode switching and water temperature setting, can be performed by inputting external signals directly to the unit.

* Optional products, such as remote controllers, are not always required.

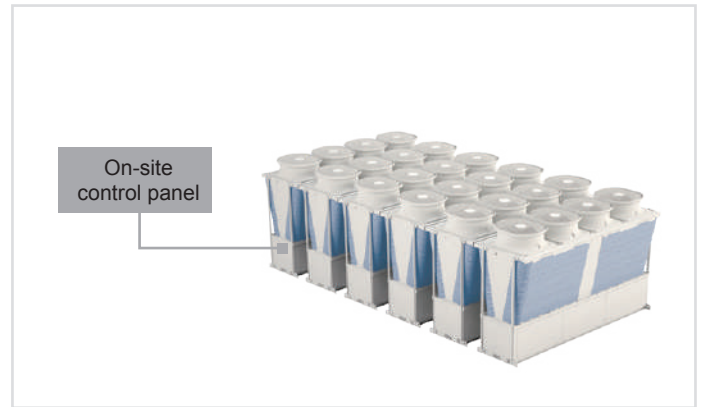

Input	ON/OFF
	Cooling/Heating
	Snow/regular
	Demand
	Target water temperature
Output	Operation mode
	Under operation
	Under defrosting
	Error
Control function (function of chiller)	Control of number of units Control to prevent simultaneous defrosting

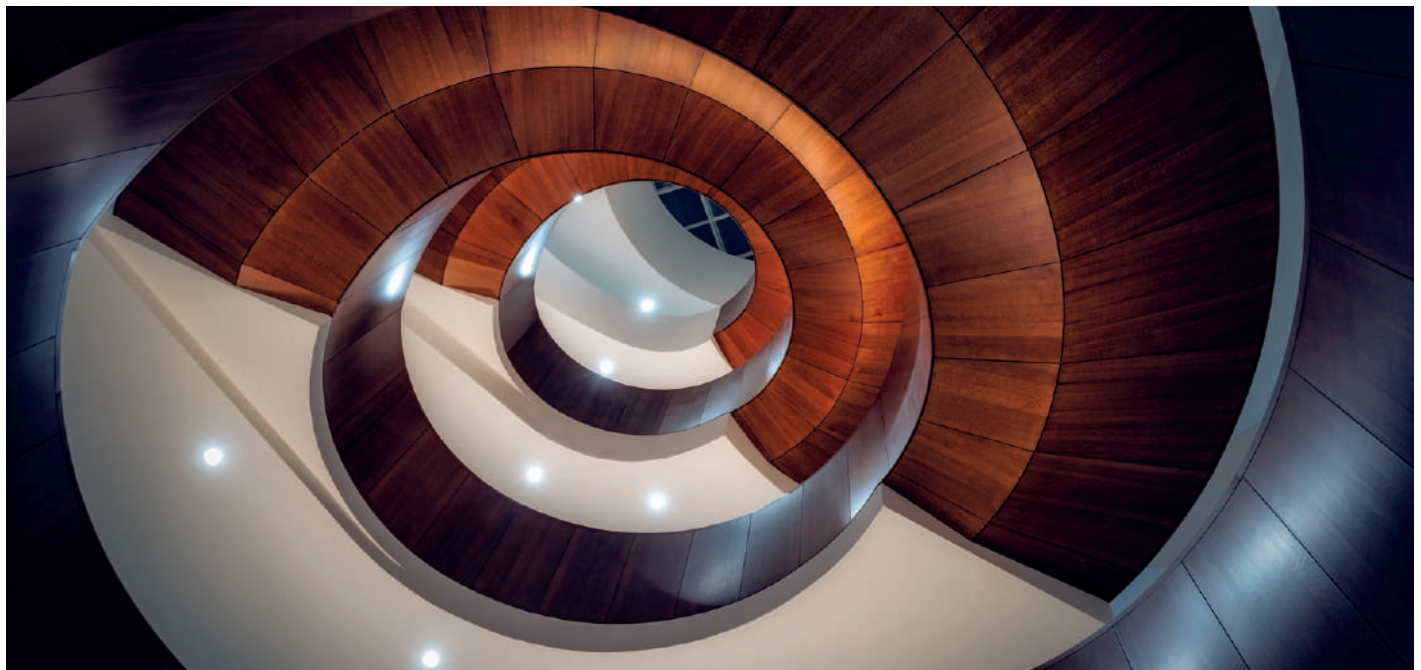



Technical specifications COOLING ONLY MODEL

MODEL		SET	EACV-P1500YBL(-N)(-BS)	EACV-P1800YBL(-N)(-BS)
Power source			3-phase 4-wire 380-400-415V 50/60Hz	
Cooling capacity *1		kW	150.00	180.00
		kcal/h	129,000	154,800
		BTU/h	511,800	614,160
	Power input	kW	45.10	59.01
	EER		3.33	3.05
	IPLV *5		6.55	6.33
	Water flow rate	m ³ /h	25.8	31.0
Cooling capacity(EN14511) *2		kW	148.58	177.76
		kcal/h	127,779	152,874
		BTU/h	506,955	606,517
	Power input	kW	46.52	61.25
	EER		3.19	2.90
	Eurovent efficiency class		A	B
	ESEER *6		4.74	4.45
	SEER		4.62	4.58
	Water flow rate	m ³ /h	25.8	31.0
	Current input	Cooling current 380-400-415V *1	A	77 - 73 - 70
Maximum current		A	111	
Water pressure drop *1		kPa	114	164
Temp range	Cooling	°C	Outlet water 5~30 *7	
		°F	Outlet water 41~86 *7	
	Outdoor	°C	-15~43 *6	
		°F	5~109.4 *6	
Circulating water volume range		m ³ /h	12.9~34.0	
Sound pressure level (measured in anechoic room) at 1m *1		dB (A)	66	68
Sound power level (measured in anechoic room) *1		dB (A)	84	86
Diameter of water pipe (Standard piping)	Inlet	mm (in)	65A (2 1/2B) housing type joint	
	Outlet	mm (in)	65A (2 1/2B) housing type joint	
Diameter of water pipe (Inside header piping)	Inlet	mm (in)	150A (6B) housing type joint	
	Outlet	mm (in)	150A (6B) housing type joint	
External finish			Polyester powder coating steel plate	
External dimension HxWxD		mm	2350 x 3400 x 1080	
Net weight	Standard piping	kg (lbs)	1240 (2734)	
	Inside header piping	kg (lbs)	1256 (2769)	
Design pressure	R410A	MPa	4.15	
	Water	MPa	1.0	
Heat exchanger	Water side		Stainless steel plate and copper brazing	
	Air side		Plate fin and copper tube	
Compressor	Type		Inverter scroll hermetic compressor	
	Maker		MITSUBISHI ELECTRIC CORPORATION	
	Starting method		Inverter	
	Quantity		4	
	Motor output	kW	11.7 x 4	
	Lubricant		MEL32	
	Fan	Air flow rate	m ³ /min	265 x 4
L/s			4417 x 4	
cfm			9357 x 4	
Type, Quantity			Propeller fan x 4	
Starting method			Inverter	
Motor output		kW	0.94 x 4	
Protection	High pressure protection		High pres.Sensor & High pres.Switch at 4.15MPa (601psi)	
	Inverter circuit		Over-heat protection, Over current protection	
	Compressor		Over-heat protection	
Refrigerant *3	Type / GWP *4		R410A / 2088	
	Factory charged	Weight	kg	12.0
		CO2 equivalent *4	t	25.06
	Maximum additional charge	Weight	kg	48.0
		CO2 equivalent *4	t	100.23
	Total charge	Weight	kg	60.0
		CO2 equivalent *4	t	125.29
	Control		LEV	

*1 Under normal cooling conditions at outdoor temp 35°CDB/24°CWB(95°FDB/75.2°FWB) outlet water temp 7°C(44.6°F) inlet water temp 12°C(53.6°F). Pump input is not included in cooling capacity and power input.

*2 Under normal cooling conditions at outdoor temp 35°CDB/24°CWB(95°FDB/75.2°FWB) outlet water temp 7°C(44.6°F) inlet water temp 12°C(53.6°F). Pump input is included in cooling capacity and power input based on EN14511.

*3 Amount of factory-charged refrigerant is 3(kg) x 4. Please add the refrigerant at the field.

*4 These values are based on Regulation(EU) No.517 / 2014.

*5 IPLV is calculated in accordance with AHRI 550-590.

*6 ESEER is calculated in accordance with EUROVENT conditions.

*Please don't use the steel material for the water piping.

*Please always make water circulate, or pull the circulation water out completely when not in use.

*Please do not use groundwater or well water in direct.

*The water circuit must be closed circuit.

*Due to continuous improvement, the above specifications may be subject to change without notice.

*This model doesn't equip with a pump.

Technical specifications HEATPUMP MODEL



MODEL		SET	EAHV-P1500YBL(-N)(-BS)	EAHV-P1800YBL(-N)(-BS)
Power source			3-phase 4-wire 380-400-415V 50/60Hz	
Cooling capacity *1		kW	150.00	180.00
		kcal/h	129,000	154,800
		BTU/h	511,800	614,160
	Power input	kW	45.10	59.01
	EER		3.33	3.05
	IPLV *7		6.55	6.33
Water flow rate	m ³ /h	25.8	31.0	
Cooling capacity(EN14511) *2		kW	148.58	177.76
		kcal/h	127,779	152,874
		BTU/h	506,955	606,517
	Power input	kW	46.52	61.25
	EER		3.19	2.90
	Eurovent efficiency class		A	B
	ESEER *8		4.74	4.45
	SEER		4.62	4.58
	Water flow rate	m ³ /h	25.8	31.0
	Heating capacity *3		kW	150.00
		kcal/h	129,000	154,800
		BTU/h	511,800	614,160
Power input		kW	44.59	55.68
COP			3.36	3.23
Water flow rate		m ³ /h	25.8	31.0
Heating capacity(EN14511) *4		kW	151.42	182.24
		kcal/h	130,221	156,726
		BTU/h	516,645	621,803
	Power input	kW	46.01	57.92
	COP		3.29	3.15
	Eurovent efficiency class		A	B
	SCOP (Reversible) Low/Medium			3.24 / 2.85
	Water flow rate	m ³ /h	25.8	31.0
Current input	Cooling current 380-400-415V *1	A		77 - 73 - 70
	Heating current 380-400-415V *3	A		76 - 72 - 69
	Maximum current	A		111
Water pressure drop *1		kPa	114	164
Temp range	Cooling	°C		Outlet water 5~30 *9
		°F		Outlet water 41~86 *9
	Heating	°C		Outlet water 30~55 *9
		°F		Outlet water 86~131 *9
	Outdoor	°C		-15~43 *9
		°F		5~109.4 *9
Circulating water volume range		m ³ /h	25.8	31.0
Sound pressure level (measured in anechoic room) at 1m *1		dB (A)	66	68
Sound power level (measured in anechoic room) *1		dB (A)	64	86
Diameter of water pipe (Standard piping)	Inlet	mm (in)	65A (2 1/2B) housing type joint	
	Outlet	mm (in)	65A (2 1/2B) housing type joint	
Diameter of water pipe (Inside header piping)	Inlet	mm (in)	150A (6B) housing type joint	
	Outlet	mm (in)	150A (6B) housing type joint	
External finish			Polyester powder coating steel plate	
External dimension HxWxD		mm	2350 x 3400 x 1080	
Net weight	Standard piping	kg (lbs)	1310 (2888)	
	Inside header piping	kg (lbs)	1326 (2923)	
Design pressure	R410A	MPa	4.15	
	Water	MPa	1.0	
Heat exchanger	Water side		Stainless steel plate and copper brazing	
	Air side		Plate fin and copper tube	
Compressor	Type		Inverter scroll hermetic compressor	
	Maker		MITSUBISHI ELECTRIC CORPORATION	
	Starting method		Inverter	
	Quantity		4	
	Motor output	kW	11.7 x 4	
	Lubricant		MEL32	
Fan	Air flow rate	m ³ /min	265 x 4	
		L/s	4417 x 4	
		cfm	9357 x 4	
	Type, Quantity		Propeller fan x 4	
Starting method		Inverter		
Motor output	kW	0.92 x 4		
Protection	High pressure protection		High pres.Sensor & High pres.Switch at 4.15MPa (601psi)	
	Inverter circuit		Over-heat protection, Over current protection	
	Compressor		Over-heat protection	
Refrigerant *5	Type / GWP *6		R410A / 2088	
	Factory charged	Weight	kg	12.0
		CO2 equivalent *6	t	25.06
	Maximum additional charge	Weight	kg	48.0
		CO2 equivalent *6	t	100.23
	Total charge	Weight	kg	60.0
CO2 equivalent *6		t	125.29	
	Control		LEV	

*1 Under normal cooling conditions at outdoor temp 35°DB/24°WB(95°FDB/75.2°FWB) outlet water temp 7°C(44.6°F) inlet water temp 12°C(53.6°F). Pump input is not included in cooling capacity and power input.
 *2 Under normal cooling conditions at outdoor temp 35°DB/24°WB(95°FDB/75.2°FWB) outlet water temp 7°C(44.6°F) inlet water temp 12°C(53.6°F). Pump input is included in cooling capacity and power input based on EN14511.
 *3 Under normal heating conditions at outdoor temp 7°DB/6°WB(44.6°FDB/42.8°FWB) outlet water temp 45°C(113°F) inlet water temp 40°C(104°F). Pump input is not included in heating capacity and power input.
 *4 Under normal heating conditions at outdoor temp 7°DB/6°WB(44.6°FDB/42.8°FWB) outlet water temp 45°C(113°F) inlet water temp 40°C(104°F). Pump input is included in heating capacity and power input based on EN14511.
 *5 Amount of factory-charged refrigerant is 3(kg) x 4. Please add the refrigerant at the field.
 *6 These values are based on Regulation(EU) No.517 / 2014.
 *7 IPLV is calculated in accordance with AHRI 550-590.
 *8 ESEER is calculated in accordance with EUROVENT conditions.
 *Please don't use the steel material for the water piping.
 *Please always make water circulate, or pull the circulation water out completely when not in use.
 *Please do not use groundwater or well water in direct.
 *The water circuit must be closed circuit.
 *Due to continuous improvement, the above specifications may be subject to change without notice.
 *This model doesn't equip with a pump.

Technical specifications HEATYNG ONLY MODEL

MODEL		SET	EAHV-P1500YBL-H(-N)(-BS)	EAHV-P1800YBL-H(-N)(-BS)
Power source			3-phase 4-wire 380-400-415V 50/60Hz	
Heating capacity *1		kW	150.00	180.00
		kcal/h	129,000	154,800
		BTU/h	511,800	614,160
	Power input	kW	44.59	55.68
	COP		3.36	3.23
	Water flow rate	m ³ /h	25.8	31.0
Heating capacity (EN14511) *2		kW	151.42	182.24
		kcal/h	130,221	156,726
		BTU/h	516,645	621,803
	Power input	kW	46.01	57.92
	COP		3.29	3.15
	Eurovent efficiency class		A	B
	SCOP (Heating only) Low/Medium		3.20 / 2.83	
	Water flow rate	m ³ /h	25.8	31.0
	Heating current 380-400-415V *3	A	76 - 72 - 69	
	Maximum current	A	111	
Water pressure drop *1		kPa	114	164
Temp range	Cooling	°C	Outlet water 30~55 *5	
		°F	Outlet water 86~131 *5	
	Outdoor	°C	-15~43 *4	
		°F	5~109.4 *4	
Circulating water volume range		m ³ /h	12.9~34.0	
Sound pressure level (measured in anechoic room) at 1m *1		dB (A)	66	67
Sound power level (measured in anechoic room) *1		dB (A)	84	86
Diameter of water pipe (Standard piping)	Inlet	mm (in)	65A (2 1/2B) housing type joint	
	Outlet	mm (in)	65A (2 1/2B) housing type joint	
Diameter of water pipe (Inside header piping)	Inlet	mm (in)	150A (6B) housing type joint	
	Outlet	mm (in)	150A (6B) housing type joint	
External finish			Polyester powder coating steel plate	
External dimension HxWxD		mm	2350 x 3400 x 1080	
Net weight	Standard piping	kg (lbs)	1310 (2888)	
	Inside header piping	kg (lbs)	1326 (2923)	
Design pressure	R410A	MPa	4.15	
	Water	MPa	1.0	
Heat exchanger	Water side		Stainless steel plate and copper brazing	
	Air side		Plate fin and copper tube	
Compressor	Type		Inverter scroll hermetic compressor	
	Maker		MITSUBISHI ELECTRIC CORPORATION	
	Starting method		Inverter	
	Quantity		4	
	Motor output	kW	11.7 x 4	
	Lubricant		MEL32	
Fan	Air flow rate	m ³ /min	265 x 4	
		L/s	4417 x 4	
		cfm	9357 x 4	
	Type, Quantity		Propeller fan x 4	
	Starting method		Inverter	
Motor output	kW	0.94 x 4		
Protection	High pressure protection		High pres.Sensor & High pres.Switch at 4.15MPa (601psi)	
	Inverter circuit		Over-heat protection, Over current protection	
	Compressor		Over-heat protection	
Refrigerant *3	Type / GWP *4		R410A / 2088	
	Factory charged	Weight	kg	12.0
		CO2 equivalent *4	t	25.06
	Maximum additional charge	Weight	kg	48.0
		CO2 equivalent *4	t	100.23
	Total charge	Weight	kg	60.0
		CO2 equivalent *4	t	125.29
	Control		LEV	

*1 Under normal heating conditions at outdoor temp 7°CDB/6°CWB(44.6°FDB/42.8°FWB) outlet water temp 45°C(113°F) inlet water temp 40°C(104°F). Pump input is not included in heating capacity and power input.

*2 Under normal heating conditions at outdoor temp 7°CDB/6°CWB(44.6°FDB/42.8°FWB) outlet water temp 45°C(113°F) inlet water temp 40°C(104°F). Pump input is included in heating capacity and power input based on EN14511.

*3 Amount of factory-charged refrigerant is 3(kg) x 4. Please add the refrigerant at the field.

*4 These values are based on Regulation(EU) No.517 / 2014.

*Please don't use the steel material for the water piping.

*Please always make water circulate, or pull the circulation water out completely when not in use.

*Please do not use groundwater or well water in direct.

*The water circuit must be closed circuit.

*Due to continuous improvement, the above specifications may be subject to change without notice.

*This model doesn't equip with a pump.

Operating limits

COOLING ONLY

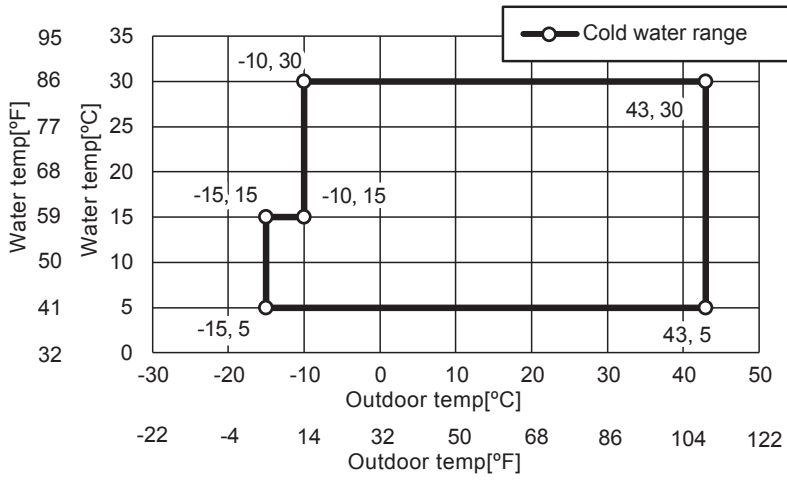

REVERSIBLE HEAT PUMP

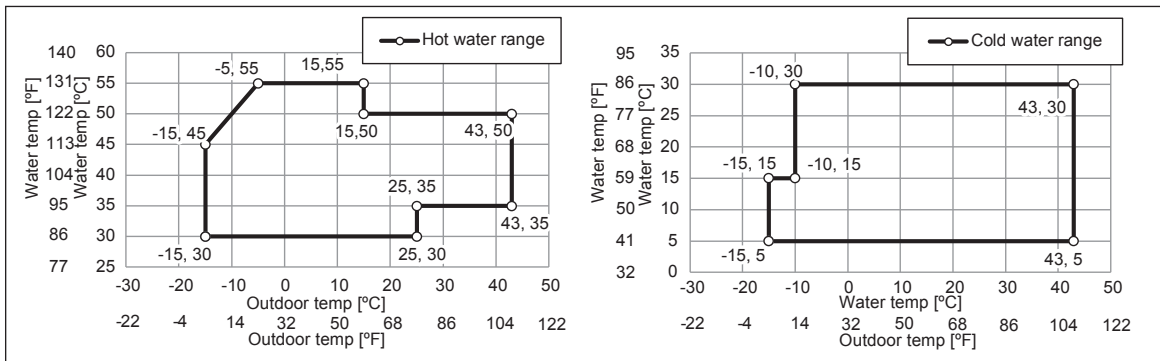

HEATING ONLY

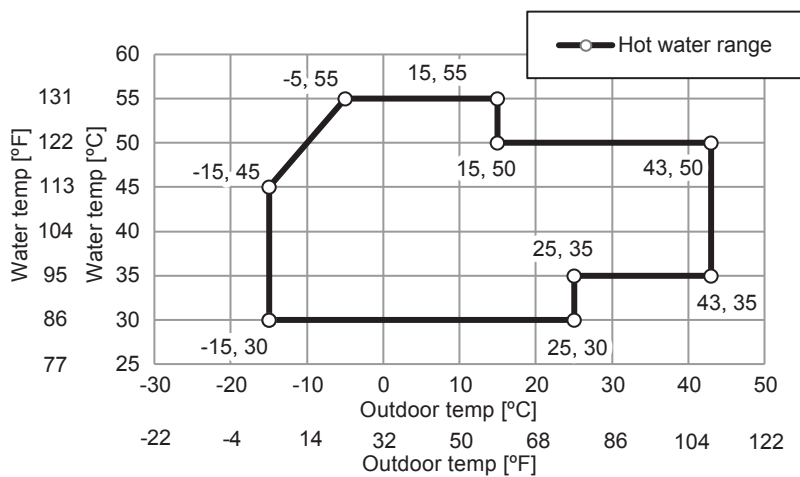

Unit converter	
kcal/h	= kW x 860
BTU/h	= kW x 3,412
lbs	= kg/0.4536
cfm	= m ³ /min x 35.31



M1500/M1800

NEW

R32

e-series

KEY COMPONENTS
SAVE ENERGY

HIGH FUNCTIONALITY
OF MODULAR CHILLERS

BEST IN CLASS
EFFICIENCY FOR
ENERGY SAVING
PERFORMANCE

WIDE OPERATING RANGE
BOTH IN COOLING AND
HEATING MODE

OPTIMUM FREQUENCY
CONTROL

LOW GWP REFRIGERANT R32
FOR REDUCED IMPACT ON
THE ENVIRONMENT

IMPROVED
REDUNDANCY &
RESILIENCE

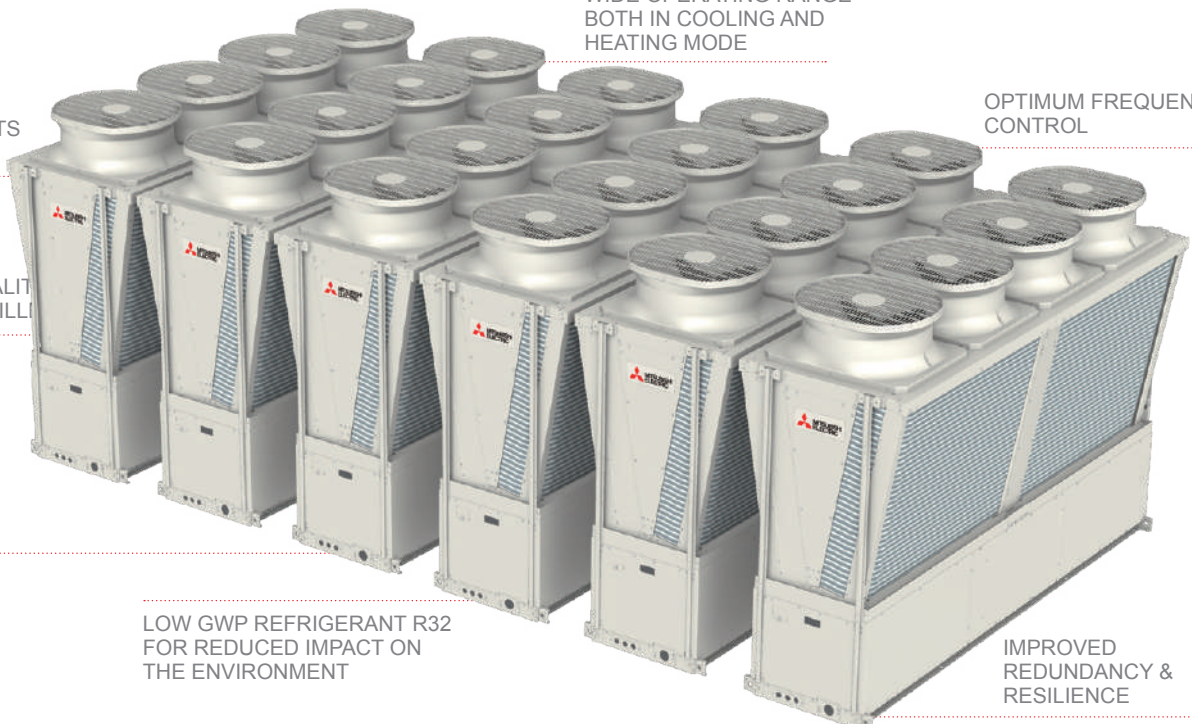

High energy-saving performance thanks to high-performance inverter compressor and proprietary Y-shaped construction.

Best in class efficiency for energy saving performance

The rated and seasonal energy efficiency ratios have been increased to achieve high energy saving performance.

Rated efficiency

The use of the high-efficiency inverter compressors achieves high energy saving performance. The 50 HP model has cooling EER and heating COP rating corresponding to energy saving class A.

Model M1500 EER 3.28 ^{*1}	Eurovent efficiency class Rank A achieved	Model M1500 COP 3.47 ^{*2}
--	--	--

^{*1} Under normal cooling conditions at outdoor temp 35°DB/24°WB(95°FDB/75.2°FWB) outlet water temp 7°C(44.6°F) inlet water temp 12°C(53.6°F). Pump input is included in cooling capacity and power input based on EN14511.
^{*2} Under normal heating conditions at outdoor temp 7°DB/6°WB(44.6°FDB/42.8°FWB) outlet water temp 45°C(113°F) inlet water temp 40°C(104°F). Pump input is included in heating capacity and power input based on EN14511.

Seasonal efficiency

The use of the high-efficiency inverter compressors ensures optimum operation according to the operation load. The compressors can operate efficiently even during nighttime and intermediate seasons with low load, thereby saving energy throughout the year.

Model M1500 SEER 5.52 ^{*1} SCOP 3.31 ^{*1}	SEERavg. +18% vs R410 version	Model M1800 SEER 5.36 ^{*1} SCOP 3.31 ^{*1}
---	--------------------------------------	---

^{*1} Compliant with EN14511

Key Components and Technologies

The high-grade functionality, energy efficiency, and endurance of the e-series are achieved by Mitsubishi Electric's technology.

Compressor

R32-compatible high-efficiency inverter compressor

Each unit has four high-efficiency R32-compatible inverter compressors. Compared to R410A, R32 has low pressure loss, contributing to better operation efficiency. The inverter compressor automatically controls the compressor frequencies based on various air-conditioning conditions such as outside air temperature and changes in load, helping to achieve higher seasonal efficiency.



Stable operation with a suction chamber injection mechanism

Returning the liquid refrigerant to the suction chamber suppresses a rise in the discharge temperature of R32 while the units are operated at low outside temperatures. The amount of injected refrigerant is adjusted according to the refrigerant state, allowing the units to operate in heating mode at an intake temperature as low as -20°C.

IH (induction heating) warmer

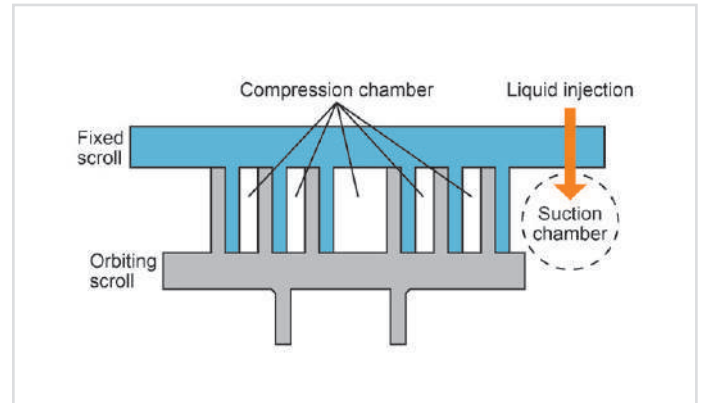

The e-series adopts an IH (induction heating) warmer to prevent refrigerant stagnation while the unit is stopped. The IH warmer suppresses standby power more than the belt case heater, which is wrapped around the compressor shell surface to constantly heat the compressor.

CASE HEATER

Heated from the outside with a heater

IH WARMER

The magnetic property of the iron motor core inside the compressor is used to heat the compressor shell and prevent refrigerant stagnation while the unit is stopped. In addition, compressor heating remains on for 30 minutes after operation is stopped, and subsequently is switched on and off every 30 minutes. Standby power consumption therefore is lower than a case heater.

<p>Heated by energizing the motor</p> <p>* Low voltage at a level that will not start up the compressor</p>	<p>Operation while the air conditioner is stopped</p> <p>On/off is repeated every 30 minutes</p>
--	---

* Normally the compressor is heated while the unit is stopped to prevent liquid refrigerant from remaining in the compressor and to evaporate the liquid refrigerant in the compressor.

Water heat exchanger

Reduction in head loss

Head loss in the water pipe is reduced by the use of a different water heat exchanger and by reducing the number of water piping routes in the unit.

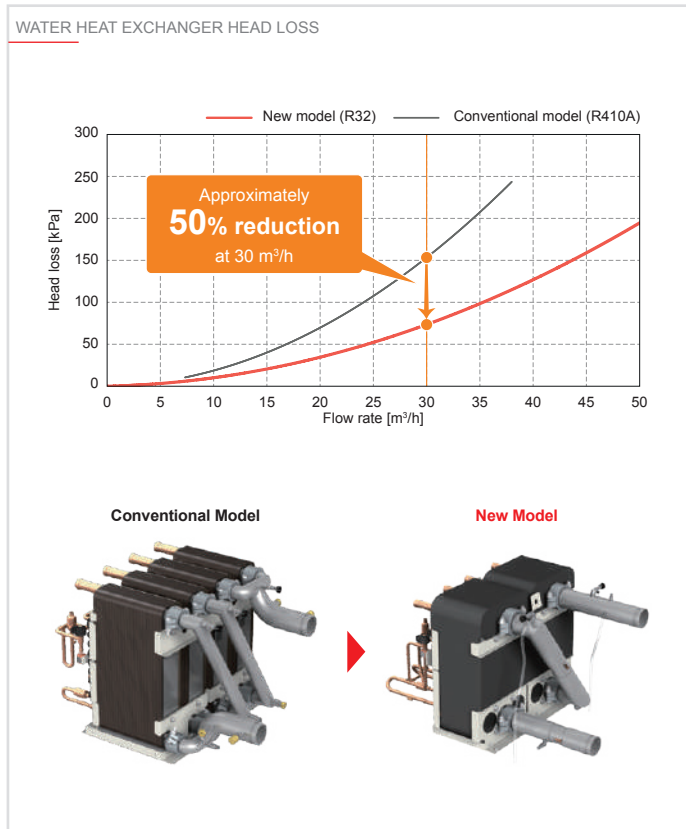

Water piping in the unit

- A water-release plug prevents water splashing when bleeding air.
- Separate air-vent valves are installed at both the inlet and outlet of the water pipes, allowing for easy water drainage just by plugging in and out the plugs.

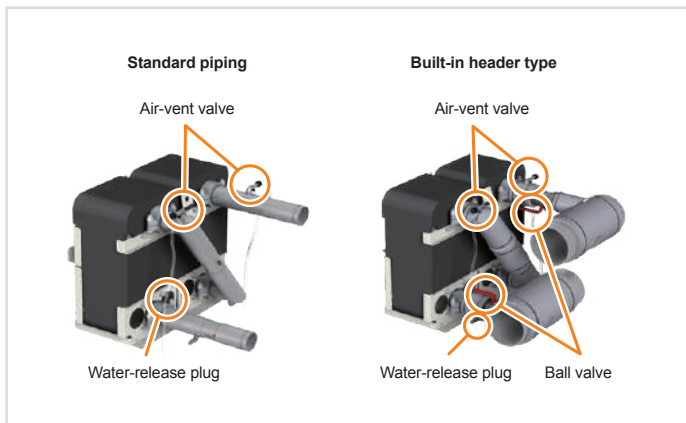

Flat tube heat exchanger

Flat tubes are sub-divided into smaller fins to increase the contact area with the refrigerant, resulting in greater heat-exchanging efficiency. The cooling only models and the heat pump models have fins that are shaped differently to increase the overall heat-exchange efficiency of each model, resulting in reduced refrigerant volume, greater operating range, and higher operation efficiency.

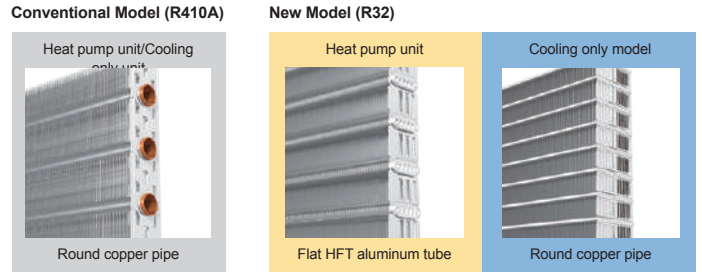

Parallel flow condenser

The heat pump and cooling only models adopt different fins in consideration of the influence of drain water clogging during heating. The heat pump model uses a horizontal flat tube and the cooling only model uses a parallel flow condenser.

The shape of the corrugated fin used in the cooling only model increases the contact area with air and the amount of heat exchange in cooling operation.

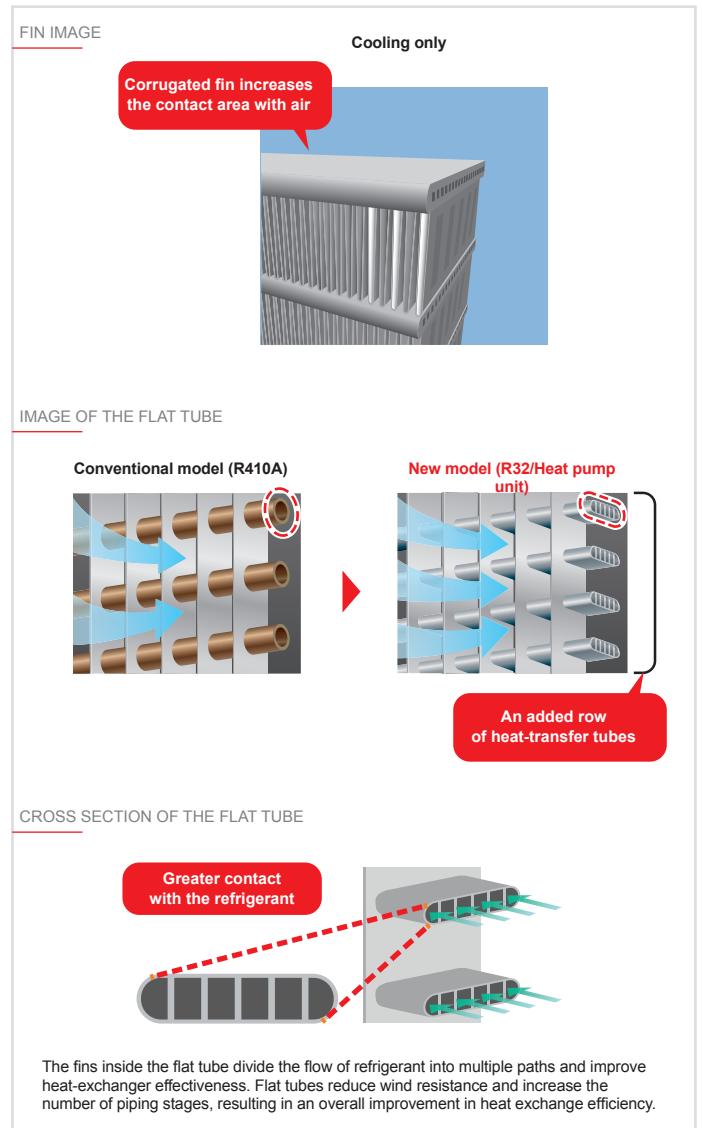

Use of Y-shape structure for effective operation

When the modules are connected, the intake air passages can be ensured on the floor and sides. This structure contributes to effective operation.



High functionality of modular chiller

The capacity among 1 group can be increased to up to 360 HP by combining units.

Large-capacity 50 HP and 60 HP units are available. Even a 360 HP system using six 60 HP units can be installed in a floor area of 8.53 m × 5.2 m including the service space

* Only modules with the same capacity can be combined.



50HP 150kW



60HP 180kW

Heat Pump	EAHV-M1500YCL(-N)
Cooling Only	EACV-M1500YCL(-N)

Heat Pump	EAHV-M1800YCL(-N)
Cooling Only	EACV-M1800YCL(-N)

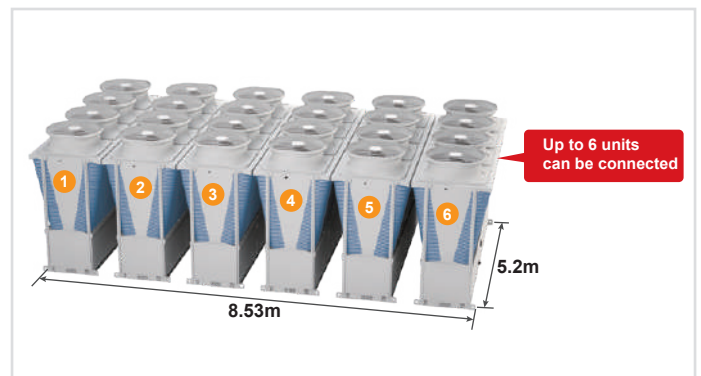

Optimum frequency control

When multiple modules are connected, the frequency of each inverter compressor is controlled during operation to increase the efficiency of each module, achieving a high energy saving performance.

This control can be implemented by simply using our unique M-NET control, without the need for any other on-site design.

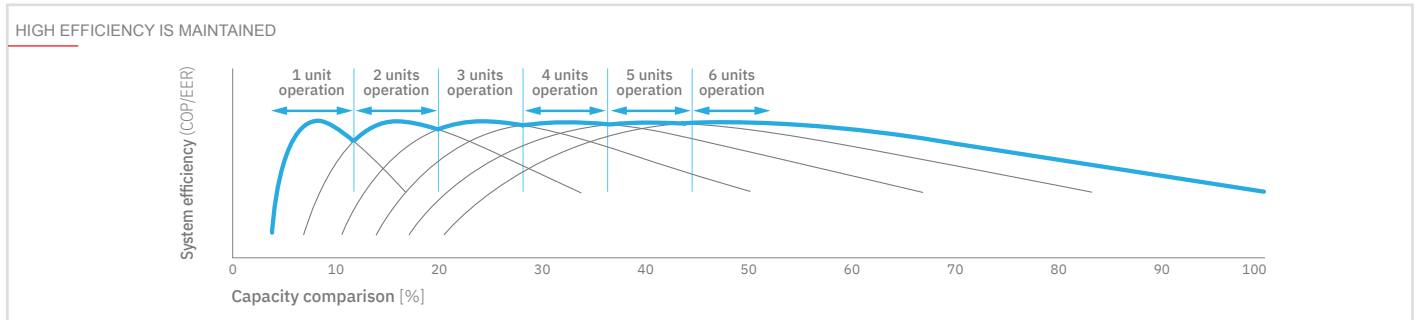

WHEN THE OVERALL SYSTEM LOAD IS 60%

Without optimum frequency control

100% 100% 100% 0% 0%

With non-inverter compressors, it is only possible to turn the unit on or off, and the compressor frequency cannot be adjusted according to the required capacity.

With optimum frequency control

60% 60% 60% 60% 60% 60%

Our modules are equipped with inverter compressors, so the system can be operated in frequency ranges in which the efficiency of each module is at its peak. Optimum frequency control of each unit increases the efficiency of the whole system.

WHEN THE OVERALL SYSTEM LOAD IS 20%

Without optimum frequency control

100% 0% 0% 0% 0%

Since the compressors are running at inefficient frequencies, the efficiency of the whole system is lower.

With optimum frequency control

60% 60% 0% 0% 0% 0%

Peak efficiency is between 40 and 60%. In low load conditions, modules can be switched off to **keep remaining modules at optimum efficiency.** The output of the pumps connected to the remaining group can be decreased, and the efficiency of the whole system is then increased. This control is achieved by connecting to M-NET. There is no need to prepare sensors, and the instrumentation is simple.

Improved redundancy & resilience

When a non-modular chiller is used as the main 300kW unit, as in this example, the same capacity would also be required as a backup. However, when a Mitsubishi Electric e-series modular chiller is used, two modules can still operate even if one module goes down, continuing normal operation. This reduces the backup capacity requirement.

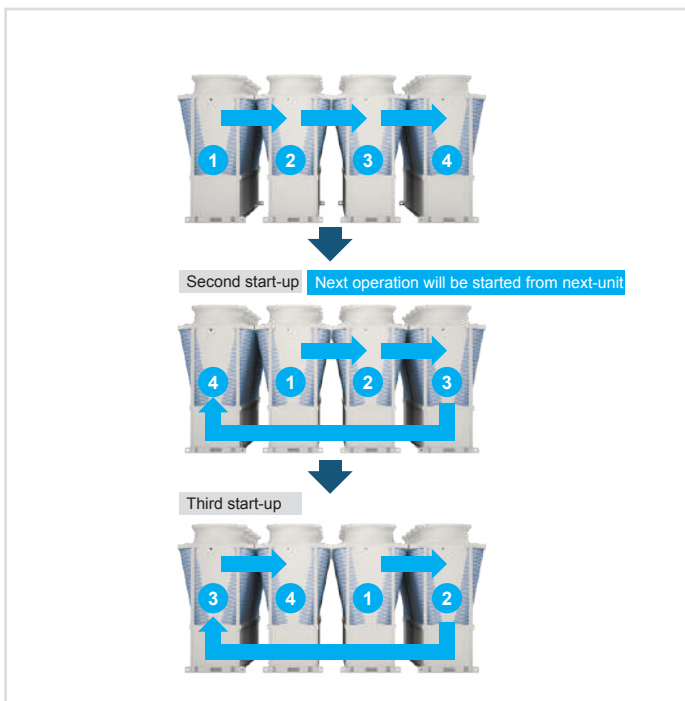
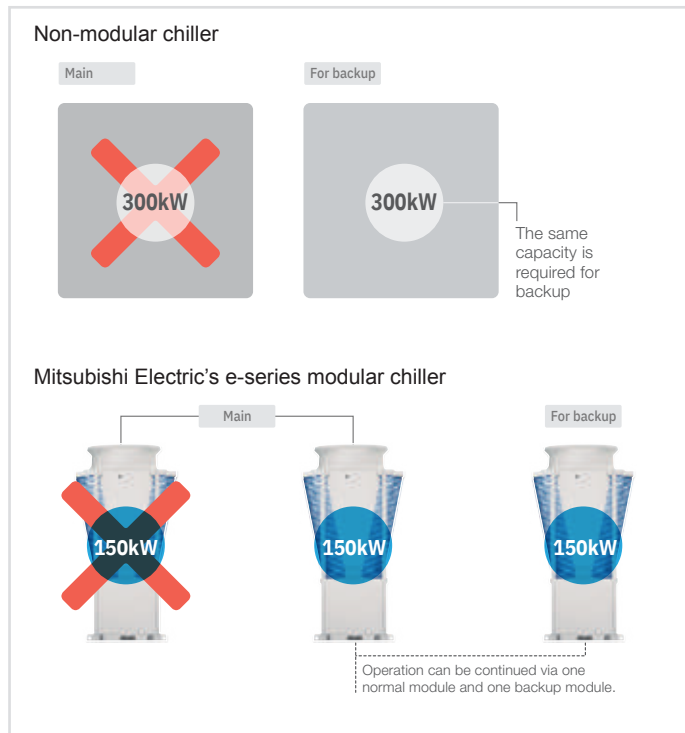

Emergency operation mode

When a single module

The e-series module contains four compressors (two for the 90kW module) developed by Mitsubishi Electric. The four compressors operate as two pairs. If something is wrong with one of the two pairs, the other pair can temporarily continue to operate. The 90kW module achieves this by operating its two compressors independently.

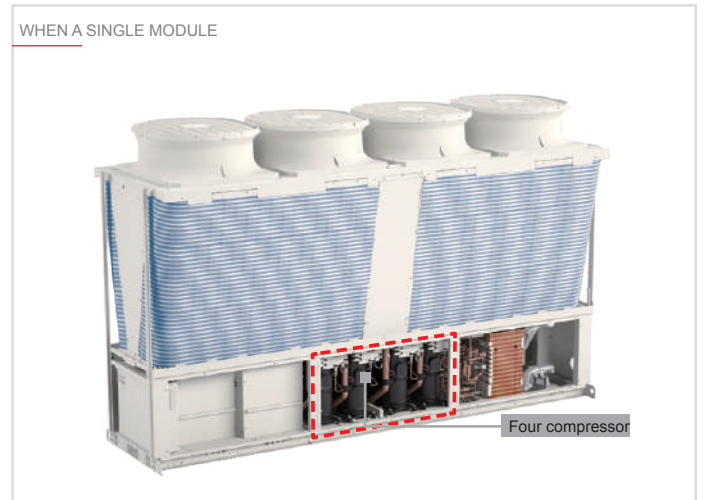

When multiple modules

If one of the e-series modules goes down, the remaining modules can continue to operate. Each module can independently control the outlet water temperature. Even if the main module goes down, operation can be continued.

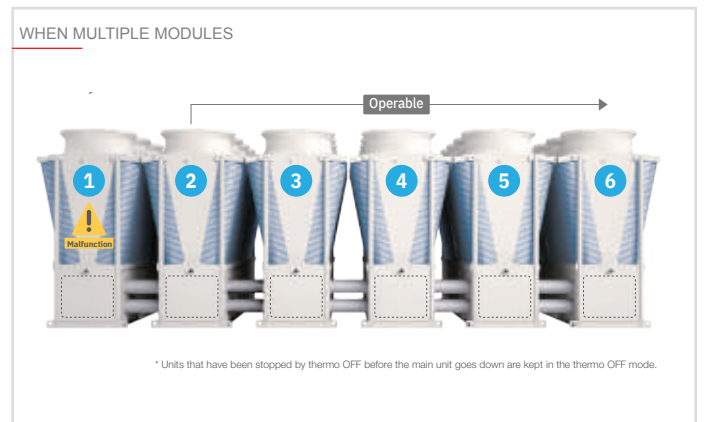

Procedure for installing the connection kit

Selectable piping system

Standard piping and built-in header types are available. The optimum type can be selected according to the design and construction needs of the building.

STANDARD PIPING TYPE	BUILT-IN HEADER TYPE (models with "-N" in the name only)
Type without built-in pump or header	Type of built-in header piping for connection between modules
Advantages The flexibility of design is high, and it is possible to select the most suitable number of pumps and water circuit for the on-site system.	Advantages The piping space and number of connections are reduced, allowing simple construction and short construction times. Advantages * It is not possible to build both the pump and the header in each unit.

Standard piping type

The flexibility of design is high, and the system can be designed according to the on-site system and load pattern. Up to 24 units (4 groups × 6 units) can be connected to one system. The number of pumps and the piping structure can be designed according to the on-site.

STANDARD PIPING TYPE
<div style="display: flex; justify-content: space-around;"> <div style="text-align: center;"> <p><System with 6 chillers and one pump></p> </div> <div style="text-align: center;"> <p><System with 6 chillers and 2 pumps></p> </div> </div>

Built-in header type

The piping to connect to other units is built into each unit. The number of piping connections is reduced (saving construction work and reducing the construction time), and the installation space can be also reduced.

BUILT-IN HEADER TYPE
<div style="display: flex; justify-content: space-around;"> <div style="text-align: center;"> <p><Standard piping construction></p> <p>* Less space and equipment cost</p> </div> <div style="text-align: center;"> <p><Built-in header type></p> <p>Piping space is reduced</p> </div> </div>
<p>SPACE FOR RETURN PIPING IS NOT REQUIRED</p> <div style="display: flex; justify-content: space-around;"> <div style="text-align: center;"> <p><Standard piping construction></p> <p>* Reduced installation work</p> </div> <div style="text-align: center;"> <p><Built-in header type> (models with "-N" in the name only)</p> <p>The piping space can be reduced.</p> <p>Piping for reverse return is not required</p> </div> </div>

Details of built-in header type modules

Up to six units with built-in headers can be connected. (Piping size: 150A)
 When 6 units or a less are connected, flow adjustment and reverse return piping for each unit are unnecessary.

Built-in header type

Header pipings, which are normally required for connecting the unit to local water pipes, are built into the unit. Multiple units are easily connectable by using optional parts. This eliminates the need to procure water pipes for connecting the units, and reduces installation work.

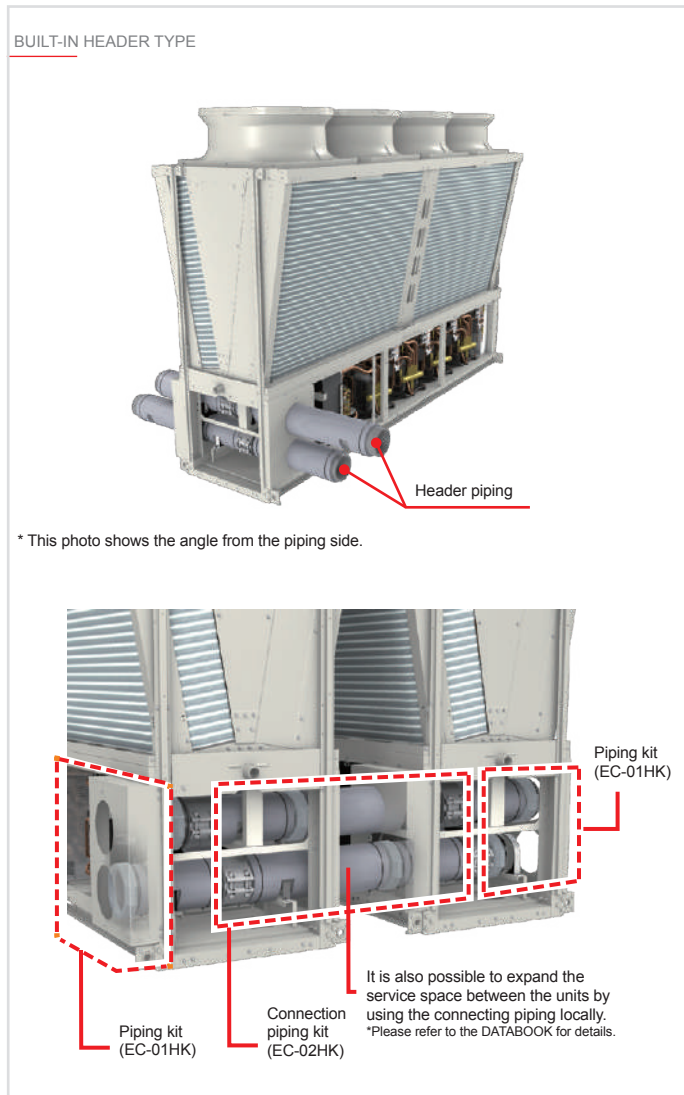

PARTS LIST

EC-01HK
 Optional parts
 (Piping kit)

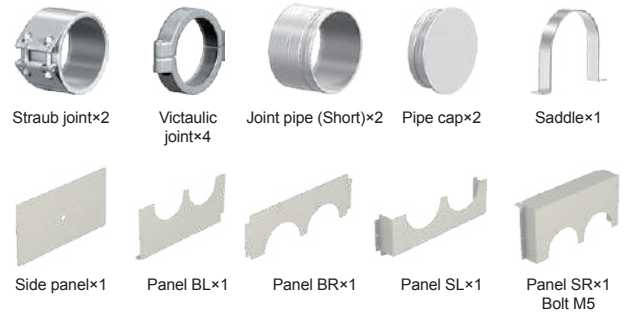

INSTALLING THE PIPING KIT (EC-01HK)

Header piping

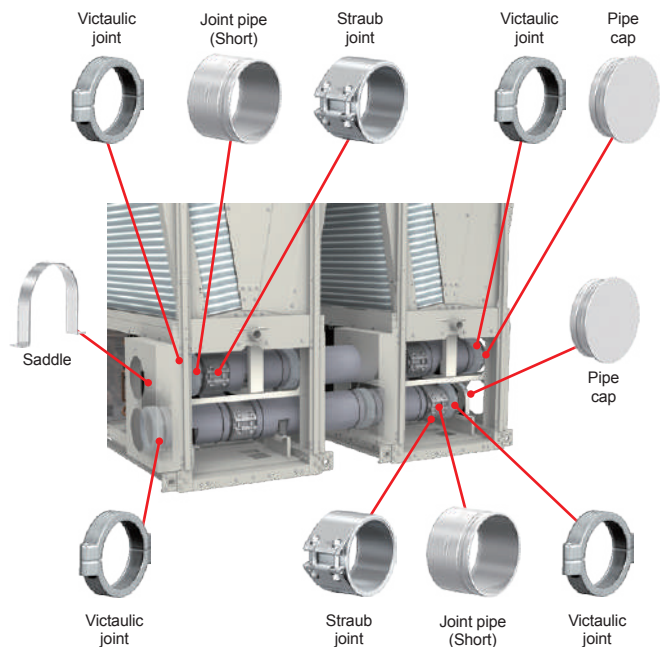

INSTALLING THE PIPING KIT (EC-01HK)

Panel

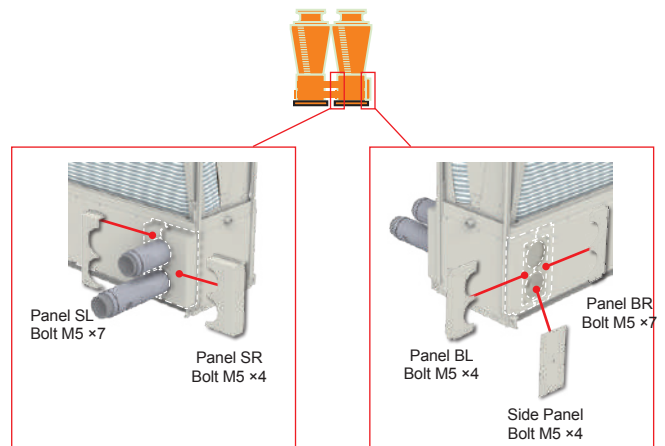

PARTS LIST

EC-02HK
(Connection piping kit)

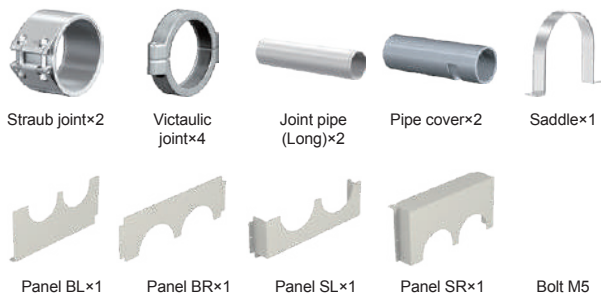

INSTALLING THE PIPING KIT (EC-02HK)

Header piping

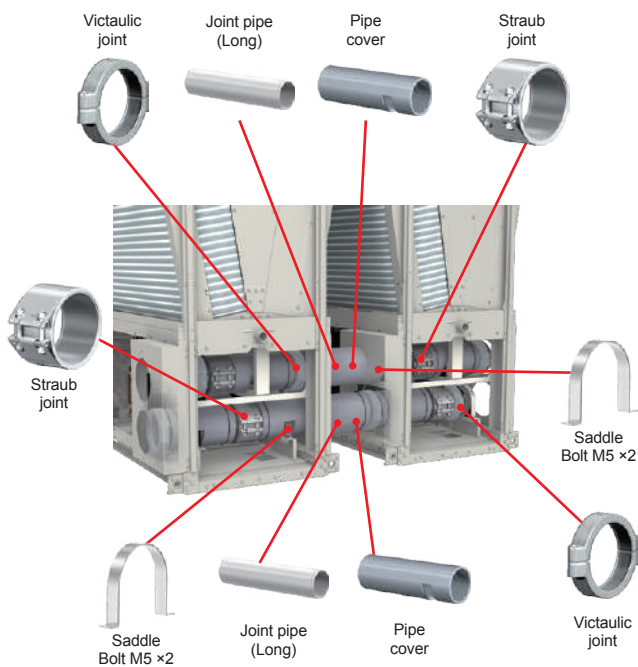

INSTALLING THE PIPING KIT (EC-02HK)

Panel

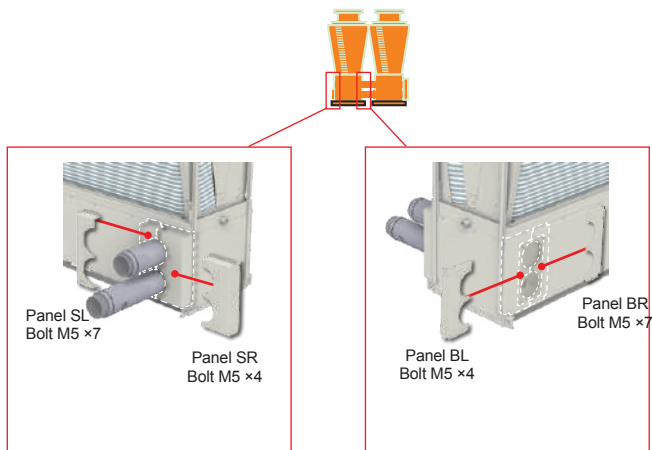

Easy control

The water temperature in each module can be controlled by using local remote controller PAR-W31MAA or by using centralized controller AE-200E. The control method can be selected at the request of each customer.

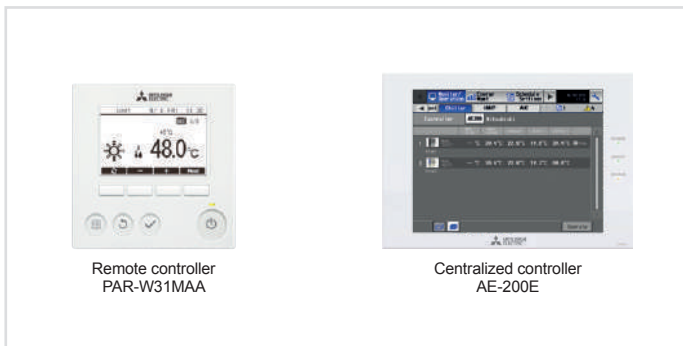

External signal input

Basic operations, such as operation command, mode switching and water temperature setting, can be performed by inputting external signals directly to the unit.

* Optional products, such as remote controllers, are not always required.



Input	ON/OFF
	Cooling/Heating
	Snow/regular
	Demand
	Target water temperature
Output	Operation command
	Operation mode
	vError
Control function (function of chiller)	Control of number of units Control to prevent simultaneous defrosting

Remote controller

Basic operations, such as ON/OFF, mode switching, water temperature setting and schedule setting, can be performed by connecting a remote controller.

Operation/setting	ON/OFF
	Cooling/Heating/HeatingECO/Anti-freeze
	Snow/Normal
	Demand
	Scheduled operation (daily/weekly)
	Target temperature
Display	Operation mode
	Current water temperature
	Target temperature
	Error code
Control function (function of chiller body)	Control of number of units
	Control to prevent simultaneous defrosting



SYSTEM CONFIGURATION

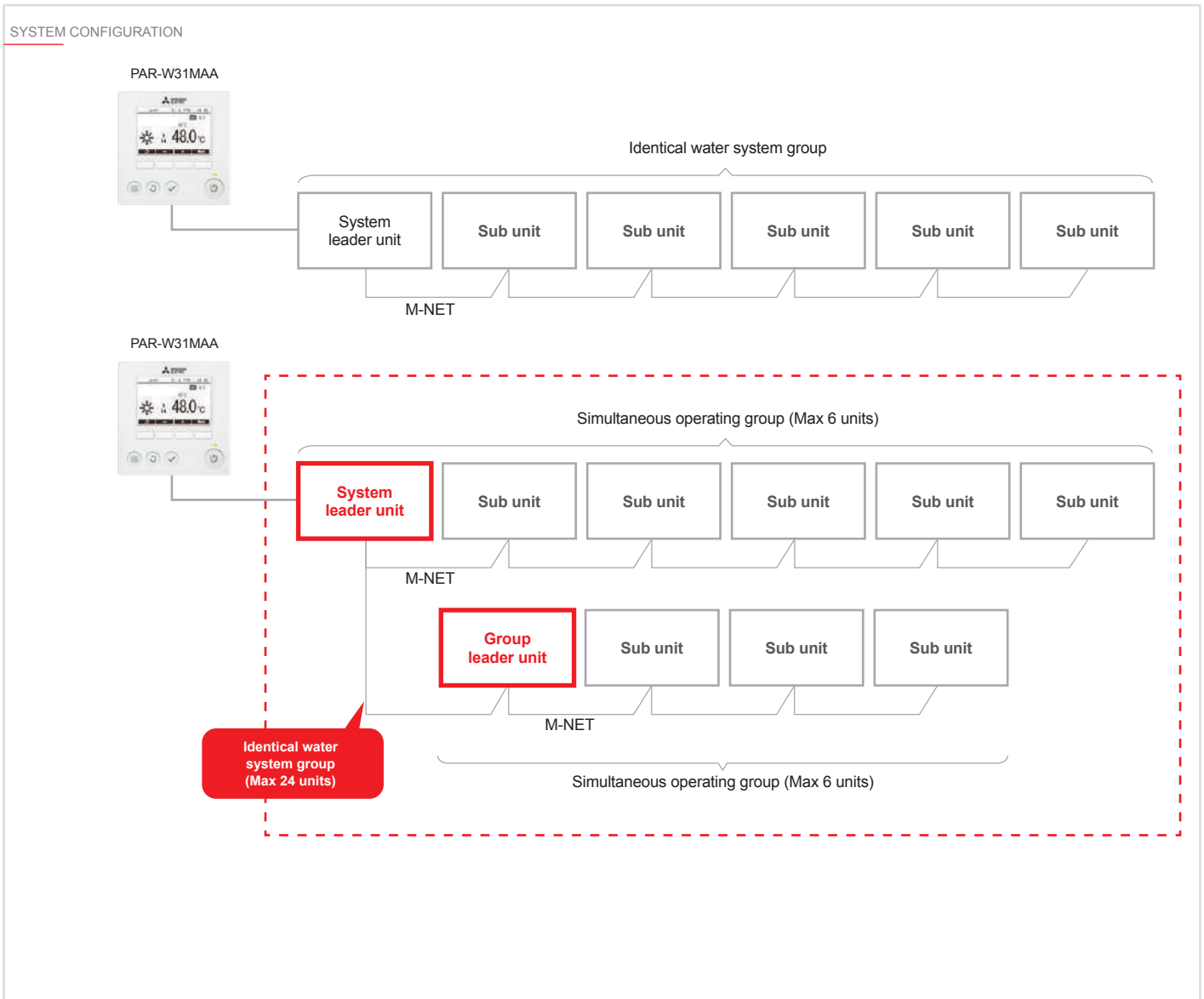

Centralized controller*

The e-series units are connectable to the AE-200E that centrally controls up to 24 units or 24 systems connected via M-NET.

By using EW-50E or AE-50E, the maximum number of connectable units can be further increased.

The use of AE-200E enables various operation settings and integrated control of the e-series and CITY MULTI.

*AE-200E with software Ver.7.8.0 or later can be connected.

Operation/setting	ON/OFF
	Cooling/Heating/HeatingECO/Anti-freeze
	Snow/Normal
	Scheduled operation (daily/weekly/annual)
	Target temperature
	Local control disabled (ON/OFF, operation mode, target temperature)
Display	WEB browser connected
	Operation mode
	Current water temperature
	Error code
Control function (function of chiller body)	Control of number of units
	Control to prevent simultaneous defrosting



Centralized controller
AE-200E

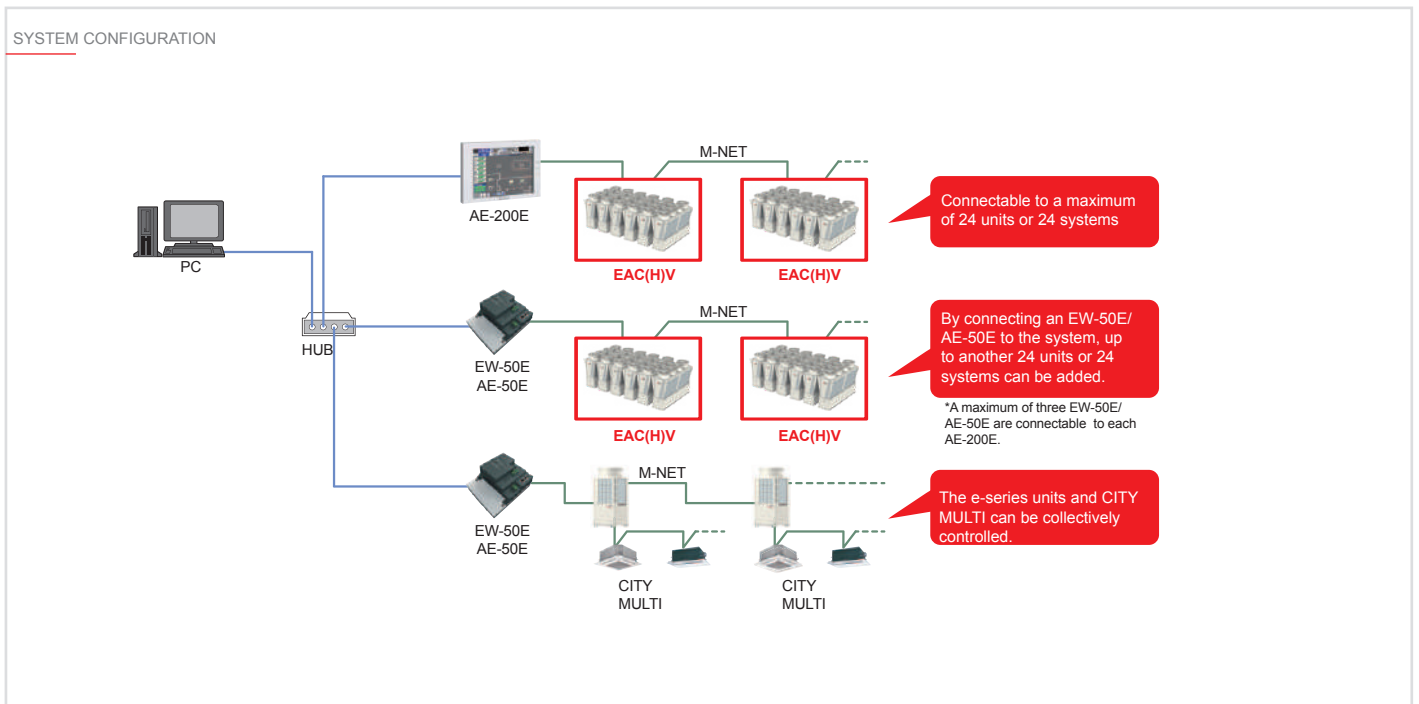

BACnet® connection function

Connectable to a central monitoring device via AE-200E using BACnet®

* BACnet® is a registered trademark of ASHRAE in the United States of America.

* BACnet® can be connected to AE-200E with software Ver.7.9.0 or later.

Operation/setting	ON/OFF
	Cooling/Heating/Heating ECO/Anti-freeze
	Snow/Normal
	Target water temperature
	Local control disabled (ON/OFF, operation mode, target temperature)
	ON/OFF
Display	Cooling/Heating/Heating ECO/Anti-freeze
	Snow/Normal
	Local control disabled (ON/OFF, operation mode, target temperature)
	Inlet/outlet water temperature
	Collective error
	Communication error
	Individual unit error

Technical specifications COOLING ONLY MODEL

MODEL	SET	EACV-M1500YCL(-N)(-BS)	EACV-M1800YCL(-N)(-BS)
Power source		3-phase 4-wire 380-400-415V 50/60Hz	
Cooling capacity *1		kW	150.00
		kcal/h	129,000
		BTU/h	511,800
	Power input	kW	44.73
	EER		3.35
	IPLV **		6.42
	Water flow rate	m ³ /h	25.8
Cooling capacity(EN14511) *2		kW	149.18
		kcal/h	128,295
		BTU/h	509,002
	Power input	kW	45.55
	EER		3.28
	Eurovent efficiency class		A
	SEER		5.52
Water flow rate	m ³ /h	25.8	
Current input	Cooling current 380-400-415V *1	A	76 - 72 - 69
	Maximum current	A	120
Water pressure drop *1		kPa	55
Temp range	Cooling	°C	Outlet water 5~30 *5
		°F	Outlet water 41~86 *5
	Outdoor	°C	-15~52 *5
		°F	5~125.6 *5
Circulating water volume range		m ³ /h	12.9~34.0
Sound pressure level (measured in anechoic room) at 1m *1		dB (A)	65
Sound power level (measured in anechoic room) *1		dB (A)	83
Diameter of water pipe (Standard piping)	Inlet	mm (in)	65A (2 1/2B) housing type joint
	Outlet	mm (in)	65A (2 1/2B) housing type joint
Diameter of water pipe (Inside header piping)	Inlet	mm (in)	150A (6B) housing type joint
	Outlet	mm (in)	150A (6B) housing type joint
External finish			Polyester powder coating steel plate
External dimension HxWxD		mm	2350 x 3400 x 1080
Net weight	Standard piping	kg (lbs)	1039 (2291)
	Inside header piping	kg (lbs)	1067 (2352)
Design pressure	R410A	MPa	4.15
	Water	MPa	1.0
Heat exchanger	Water side		Stainless steel plate and copper brazing
	Air side		Salt-resistant corrugated fin & aluminium micro channel
Compressor	Type		Inverter scroll hermetic compressor
	Maker		MITSUBISHI ELECTRIC CORPORATION
	Starting method		Inverter
	Quantity		4
	Motor output	kW	11.7 x 4
	Lubricant		MEL46EH
Fan	Air flow rate	m ³ /min	4500 x 4
		L/s	9534 x 4
		cfm	
	Type, Quantity		Propeller fan x 4
Starting method		Inverter	
Motor output	kW	0.92 x 4	
Protection	High pressure protection		High pres.Sensor & High pres.Switch at 4.15MPa (601psi)
	Inverter circuit		Over-heat protection, Over current protection
	Compressor		Over-heat protection
Refrigerant *3	Type x charge		R32 x 4.7 (kg) x 4 *3
	Control		LEV

*1 Under normal cooling conditions at outdoor temp 35°C DB / 24°C WB (95°F DB / 75.2°F WB) outlet water temp 7°C (44.6°F) inlet water temp 12°C (53.6°F). Pump input is not included in cooling capacity and power input.

*2 Under normal cooling conditions at outdoor temp 35°C DB / 24°C WB (95°F DB / 75.2°F WB) outlet water temp 7°C (44.6°F) inlet water temp 12°C (53.6°F). Pump input is included in cooling capacity and power input based on EN14511.

*3 Amount of factory-charged refrigerant is 3 (kg) x 4. Please add the refrigerant at the field.

*4 IPLV is calculated in accordance with AHRI 550-590.

*Please don't use the steel material for the water piping.

*Please always make water circulate, or pull the circulation water out completely when not in use.

*Please do not use groundwater or well water directly.

*The water circuit must be closed circuit.

*Due to continuous improvement, the above specifications may be subject to change without notice.

*This model is not equipped with a pump.

Technical specifications HEATPUMP MODEL

MODEL	SET	EAHV-M1500YCL(-N)(-BS)	EAHV-M1800YCL(-N)(-BS)	
Power source		3-phase 4-wire 380-400-415V 50/60Hz		
Cooling capacity *1		kW	150.00	180.00
		kcal/h	129,000	154,800
		BTU/h	511,800	614,160
	Power input	kW	44.73	57.02
	EER		3.35	3.16
	IPLV *6		6.42	6.31
Cooling capacity(EN14511) *2	Water flow rate	m ³ /h	25.8	31.0
		kW	149.18	178.80
		kcal/h	128,295	153,768
		BTU/h	509,002	610,066
	Power input	kW	45.55	58.22
	EER		3.28	3.07
Heating capacity *3	Eurovent efficiency class		A	B
	SEER		5.52	5.36
	Water flow rate	m ³ /h	25.8	31.0
		kW	150.00	180.00
		kcal/h	129,000	154,800
		BTU/h	511,800	614,160
Heating capacity(EN14511) *4	Power input	kW	42.61	53.09
	COP		3.52	3.39
	Water flow rate	m ³ /h	25.8	31.0
		kW	150.82	181.20
		kcal/h	129,705	155,832
		BTU/h	514,598	618,254
Current input	Power input	kW	43.43	54.29
	COP		3.47	3.34
	SCOP Low temp. application/Medium temp. applic.		3.31 / 2.88	
	Water flow rate	m ³ /h	25.8	31.0
	Cooling current 380-400-415V *1	A	76 - 72 - 69	96 - 91 - 88
	Heating current 380-400-415V *3	A	72 - 68 - 66	90 - 85 - 82
Maximum current	A	120		
Water pressure drop *1	kPa	55	78	
Temp range	Cooling	°C	Outlet water 4~30 *7	
		°F	Outlet water 39.2~86 *7	
	Heating	°C	Outlet water 25~55 *7	
		°F	Outlet water 77~131 *7	
	Outdoor (Cooling)	°C	-15~-52 *7	
		°F	5~125.6 *7	
Outdoor (Heating)	°C	-20~43 *7		
	°F	-4~109.4 *7		
Circulating water volume range	m ³ /h	12.9~34.0		
Sound pressure level (measured in anechoic room) at 1m *1	dB (A)	65	67	
Sound power level (measured in anechoic room) *1	dB (A)	83	85	
Diameter of water pipe (Standard piping)	Inlet	mm (in)	65A (2 1/2B) housing type joint	
	Outlet	mm (in)	65A (2 1/2B) housing type joint	
Diameter of water pipe (Inside header piping)	Inlet	mm (in)	150A (6B) housing type joint	
	Outlet	mm (in)	150A (6B) housing type joint	
External finish			Polyester powder coating steel plate	
External dimension HxWxD		mm	2350 x 3400 x 1080	
Net weight	Standard piping	kg (lbs)	1280 (2822)	
	Inside header piping	kg (lbs)	1307 (2881)	
Design pressure	R410A	MPa	4.15	
	Water	MPa	1.0	
Heat exchanger	Water side		Stainless steel plate and copper brazing	
	Air side		Plate fin and copper tube	
Compressor	Type		Inverter scroll hermetic compressor	
	Maker		MITSUBISHI ELECTRIC CORPORATION	
	Starting method		Inverter	
	Quantity		4	
	Motor output	kW	11.5 x 4	
	Lubricant		MEL46EH	
Fan	Air flow rate	m ³ /min	270 x 4	
		L/s	4500 x 4	
		cfm	9534 x 4	
	Type, Quantity		Propeller fan x 4	
	Starting method		Inverter	
	Motor output	kW	0.92 x 4	
Protection	External static press.	Pa	20	
	High pressure protection		High pres.Sensor & High pres.Switch at 4.15MPa (601psi)	
Refrigerant *5	Inverter circuit		Over-heat protection, Over current protection	
	Compressor		Over-heat protection	
	Type x charge		R32 x 11.5 (kg) x 4 *5	
	Control		LEV	

*1 Under normal cooling conditions at outdoor temp 35°C DB / 24°C WB (95°F DB / 75.2°F WB) outlet water temp 7°C (44.6°F) inlet water temp 12°C (53.6°F). Pump input is not included in cooling capacity and power input.

*2 Under normal cooling conditions at outdoor temp 35°C DB / 24°C WB (95°F DB / 75.2°F WB) outlet water temp 7°C (44.6°F) inlet water temp 12°C (53.6°F). Pump input is included in cooling capacity and power input based on EN14511.

*3 Under normal heating conditions at outdoor temp 7°C DB / 6°C WB (44.6°F DB / 42.8°F WB) outlet water temp 45°C (113°F) inlet water temp 40°C (104°F). Pump input is not included in heating capacity and power input.

*4 Under normal heating conditions at outdoor temp 7°C DB / 6°C WB (44.6°F DB / 42.8°F WB) outlet water temp 45°C (113°F) inlet water temp 40°C (104°F). Pump input is included in heating capacity and power input based on EN14511.

*5 Amount of factory-charged refrigerant is 3 (kg) x 4. Please add the refrigerant at the field.

*6 IPLV is calculated in accordance with AHRI 550-590.

*Please don't use the steel material for the water piping.

*Please always make water circulate, or pull the circulation water out completely when not in use.

*Please do not use groundwater or well water directly.

*The water circuit must be closed circuit.

*Due to continuous improvement, the above specifications may be subject to change without notice.

*This model is not equipped with a pump.

Operating limits

COOLING ONLY

Operable in cooling mode at an intake air temperature of up to 52°C.

The use of the flat tube heat exchanger has made it possible to increase the maximum intake air temperature from 43°C to 52°C in cooling mode, extending the cooling performance of the units in intense heat and in collective installation.

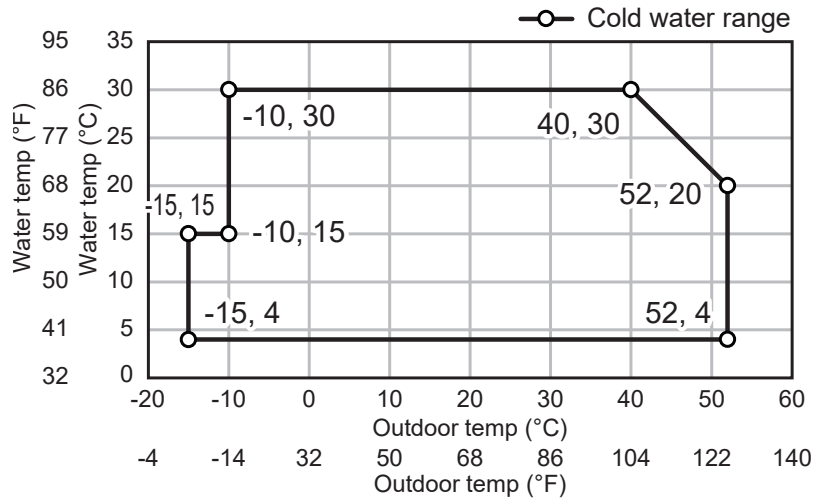

REVERSIBLE HEAT PUMP

Operable in heating mode at an intake air temperature of down to -20°C.

The new model has a greater heating capacity range due to the flat tube heat exchanger and the suction chamber injection mechanism of the compressor. It is operable at the minimum intake air temperature of -20°C and the minimum outlet water temperature of 25°C. The new model is suitable for use in manufacturing lines requiring heating throughout the year.

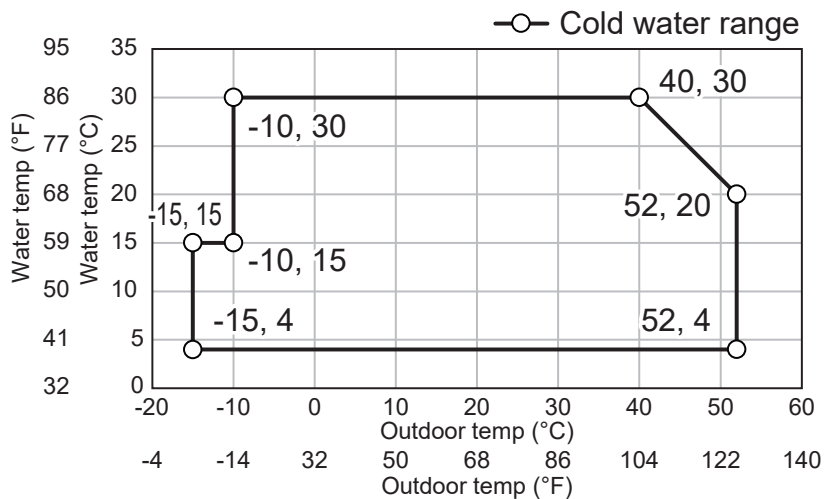
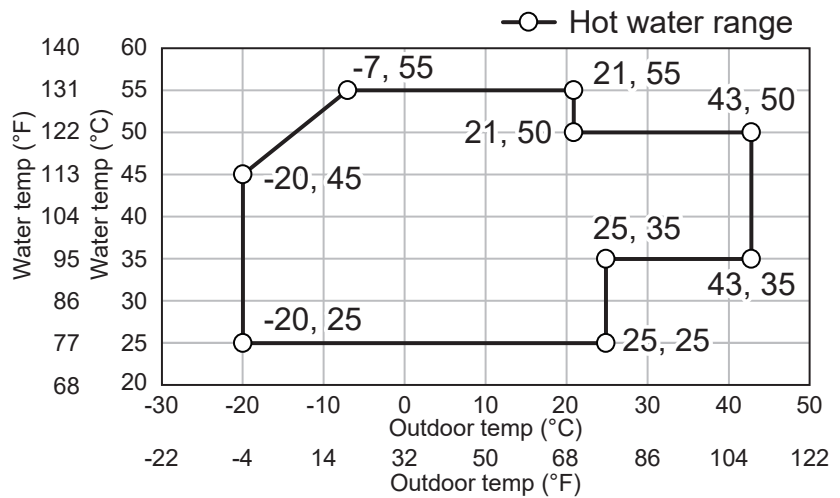

R32 refrigerant properties

Under the conditions shown below, there is a possibility that R32 could burn.

	R32	R410	R22
Chemical formula	CH ₂ F ₂	CH ₂ F ₂ /CHF ₂ CF ₃	CHClF ₂
Composition (blend ratio wt. %)	Single composition	R32/R125 (50/50 wt %)	Single composition
Ozone depletion potential (ODP)	0	0	0.055
Global warming potential (GWP) *1	675	2088	1810
LFL(vol.%) *2	13.3	-	-
UFL(vol.%) *3	29.3	-	-
Flammability *4	Lower flammability (2L)	No flame propagation (1)	No flame propagation (1)

*1 IPCC 4th assessment report

*2 LFL: Lower flammable limit

*3 UFL: Upper flammable limit

*4 ISO 817:2014

*5 R32 consistency is higher than LFL*2 and lower than UFL*3.

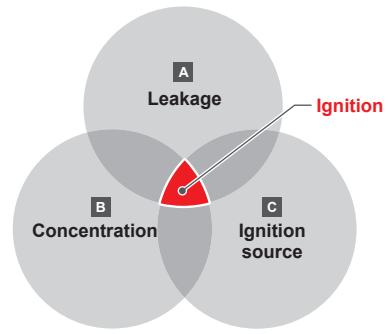

- A Do not leak refrigerant.**
 - <Installation>
 - Vacuum drying should be done.
 - Do not release refrigerant into the atmosphere unnecessarily.
 - Follow "Installation points of charging refrigerant."
 - <Repair/Removal>
 - Refrigerant should be recovered.
- B Prevent concentration.**
 - Follow "Installation restrictions".
- C Keep ignition sources away from the unit.**
 - Do not braze pipes that contain refrigerant. Before brazing, refrigerant should be recovered.
 - Do not install the unit while electricity is on. Turn off electricity and check using a tester.
 - Do not smoke during work and transportation.

Note: Both R32 / R410A emit toxic gas when exposed to naked flame.

TOOLS	Gauge manifold	Charge hose	Electronic weight scales	Charge valve	Electric leak tester (Gas leak detector)	Vacuum pump	Vacuum pump adapter	Refrigerant recovery equipment *1	Refrigerant recovery cylinder *2
R32	Shareable *3	Shareable *3	Shareable *3	Shareable *3	Shareable *3	Shareable *3	Shareable *3	Shareable *3	EXCLUSIVE
R410	Shareable *3	Shareable *3	Shareable *3	Shareable *3	Shareable *3	Shareable *3	Shareable *3	Shareable *3	EXCLUSIVE

NOTE: Be sure to confirm with the manufacturers that the electric leak tester, vacuum pump and refrigerant recovery equipment are compliant with R32.

*1 Refer to catalogs provided by the manufacturers of the tools above to ensure that the tools are usable with R32.

*2 Do not use R32 and R410A in combination in the same refrigerant recovery cylinder.

*3 The types of tools required for R32 units and R410A units are the same. Each tool must be used only with either R32 units or R410A units.

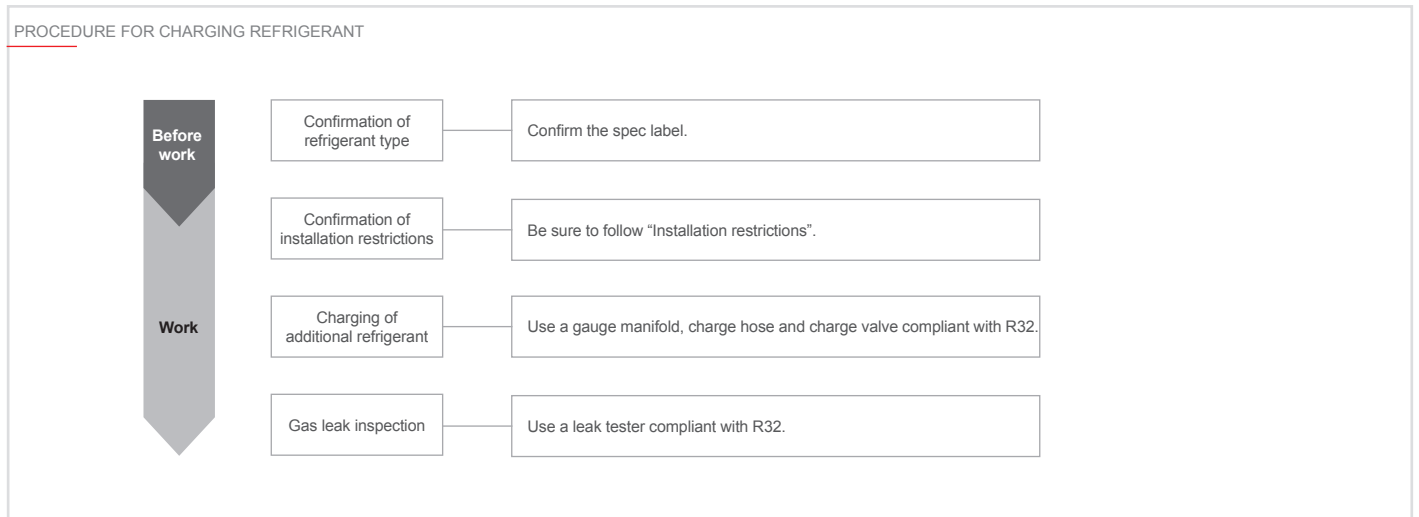

Installation restrictions

Do not install the unit where combustible gas may leak

- If combustible gas accumulates around the unit, fire or explosion may result.

- Provide sufficient space around the unit for effective operation, efficient air movement, and ease of access for maintenance.
- All restrictions mentioned in this manual apply not only to new installations but also to relocations and layout changes.
- Refer to the Installation manual for other precautions on installation

Installation space requirement

- Do not install the unit inside a building such as the basement or machine room, where the refrigerant may stagnate.
- Install the unit in a place where at least one of four sides is open.

CORRECT INSTALLATION

If the unit needs to be installed in a space where all four sides are blocked, confirm that one of the following situations (A or B) is satisfied.

A Install the unit in a space with a wall height of ≤ 0.125 m.

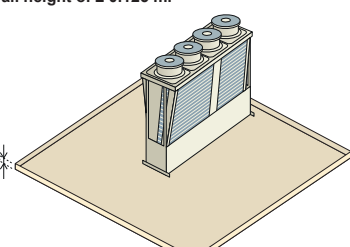

Wall height ≤ 0.125 m
(No restrictions apply to the refrigerant amount)

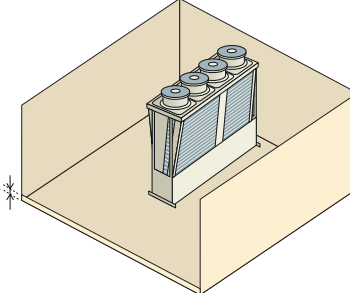

Wall height ≤ 0.125 m

B Create an appropriate ventilation opening.

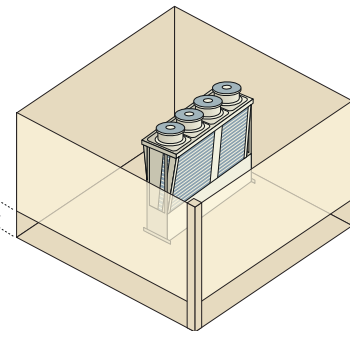

Wall opening > 0.5 m

CORRECT INSTALLATION

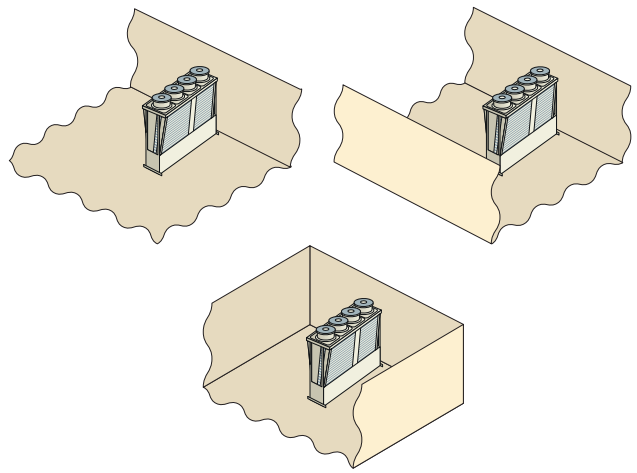

INCORRECT INSTALLATION

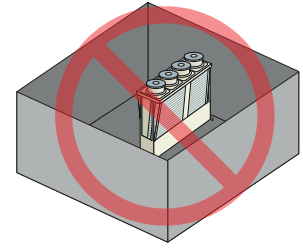

Regulatory requirements for safety

See below for information on installing a safety device on the air cooled chilling unit system

* Safety devices shall be regularly inspected, maintained, and replaced in accordance with relevant laws, regulations, and the instructions of the manufacturers.

* The requirements listed below were established based on IEC60335-2-40 (Edition 5.0) G.G.6. See the original standards for further information on selecting a safety device.

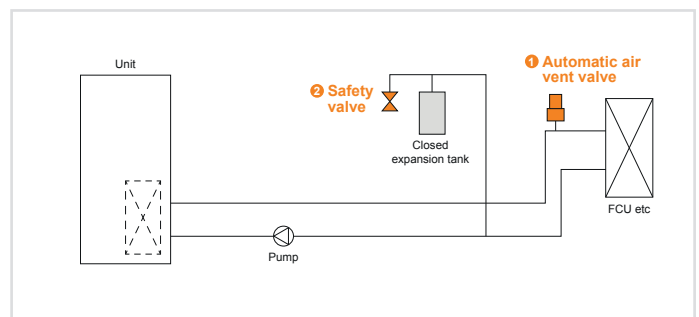

Required items	Note
Automatic air vent valve	* In the event of a failure of the waterside heat exchanger in the unit, the refrigerant may leak from the automatic air vent valve, so install it in a place where the refrigerant will not accumulate, such as outdoors.
Safety valve	* In the event of a failure of the waterside heat exchanger in the unit, the refrigerant may leak from the safety valve, so install it in a place where the refrigerant will not accumulate, such as outdoors.

IT Cooling

s-MEXT split system

s-MEXT split System		342
s-MEXT G00 System	NEW	348
s-MEXT G00 Indoor Unit	NEW	350
Mr. SLIM Outdoor Unit	NEW	352

MULTIDENSITY modular system

MULTIDENSITY	NEW	354
m-MOCU	NEW	358
m-MROW / m-MRAC	NEW	362





s-MEXT split system

Close Control Unit for IT Cooling applications.
Direct expansion system, full inverter for Edge Data Center.



Edge computing: the new trend for cloud decentralization

A new concept that places it self side by side to cloud computing is appearing on the market, thanks to the unstoppable digital transformation we are experiencing. It's the Edge computing.

In 2018, into the top ten strategic technological trends for companies and organizations, Gartner, a leading company in research and consulting, reported the "Cloud to the Edge" trend in fifth position.

This technology imposes the cloud decentralization, which translate into a new reference model for designing data centers. Concepts like IoT, 5G will inevitably lead a resources fragmentation in data centers

management. In fact, we speak of granularity, investments in smaller and widespread data centers, developed to respond to the growing demand for web connections with low latency and high performances.

As result, data processing times will have to be faster, and the only way to comply with both the connections' growing number and consumers' needs in terms of performances will have to be, according to the experts, to data processing closer to the users themselves.

Then we start to talk about Edge Data Centers, little data centers or server rooms, scattered on territory and used to host cloud services and local data processing.



cloud

users



cloud

edge
datacenter

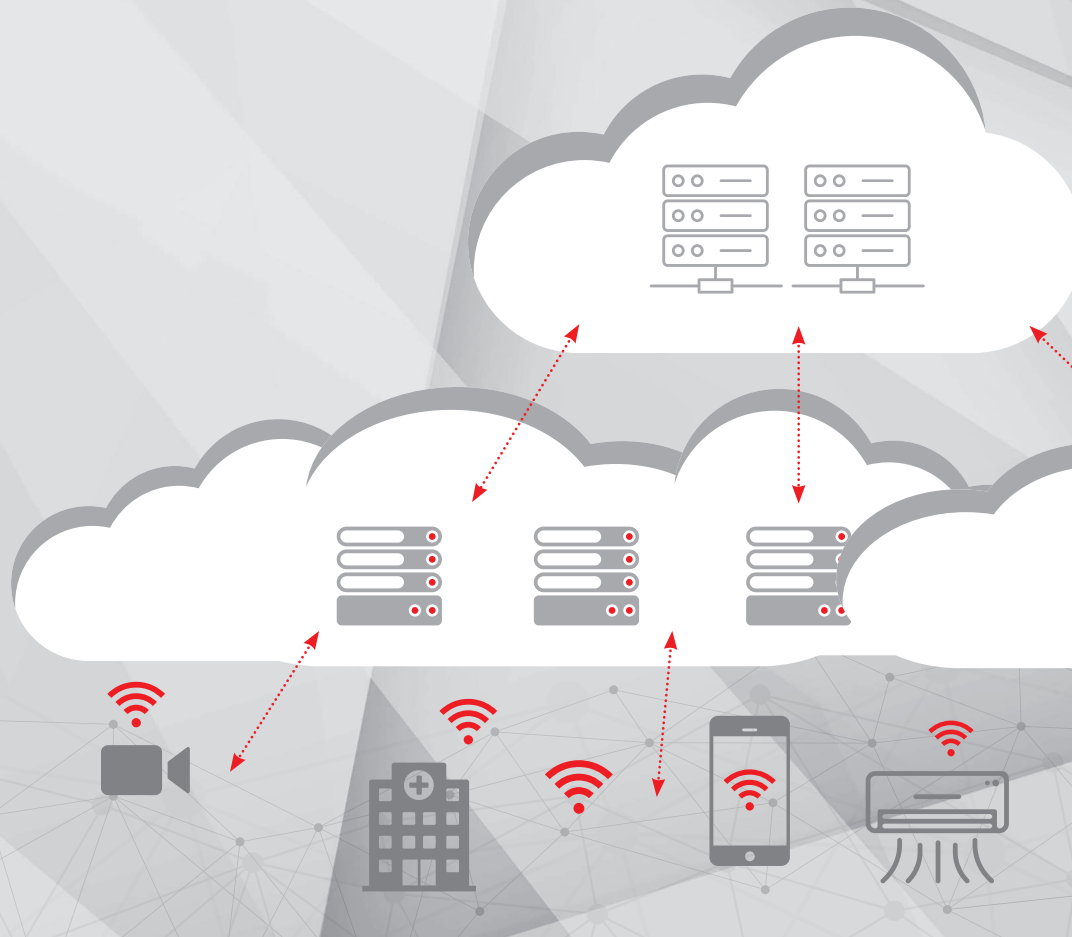



Cloud Computing

Traditional cloud model

The traditional model is facing some latency problems, limited bandwidth, dependability that cause traffic congestions, not suitable for future IoT implementations.

Advantages: large data processing capacity for complex analysis.

Products and applications: chillers, precision conditioners, infrastructures, control systems and accessories with RC brand.



Edge Computing

Distributed intelligence model

Edge computing, by distributing intelligence, will bring down the reduction of the amount of data to be processed, prioritizing management of critical data, latency sensitive, next to the users, filtering and passing to the cloud less impacting data. It will manage big data processing.

Advantages: low latency, high elaboration performances with less investments in infrastructures.

Products and applications: precision air conditioners, infrastructures, control systems and accessories branded Mitsubishi Electric and RC.







s-MEXT G00 system NEW

R410A

R32

HIGH EFFICIENCY LEVEL,
REDUCED OCCUPATION



Under



Over

S-MEXT COMBINES MORE THAN 50 YEARS OF EXPERIENCE OF RC BRAND IN THE IT COOLING MARKET, WITH THE MITSUBISHI ELECTRIC EXCELLENCE QUALITY.

S-MEXT AND MR. SLIM
PERFECT SYNERGY



MITSUBISHI ELECTRIC QUALITY
READY TO SERVE YOUR EDGE
DATA CENTER



Mitsubishi Electric present s-MEXT, developed with the RC experience and notoriety in the IT Cooling market: the brand new combined system that combines all the experience of a specialized brand in precision air conditioning with the technological excellence and reliability of Mitsubishi Electric.

The innovative system dedicated to Edge Data Center combines a precision air conditioner (indoor unit) with the commercial outdoor unit of Mr.Slim series.

Best kW/m² Ratio

Thanks to the innovative system, s-MEXT guarantees high level performances while occupying very small floor space. It's compact layout allows to easily integrate the unit in existing data centers, without sacrificing any kW per square meter.

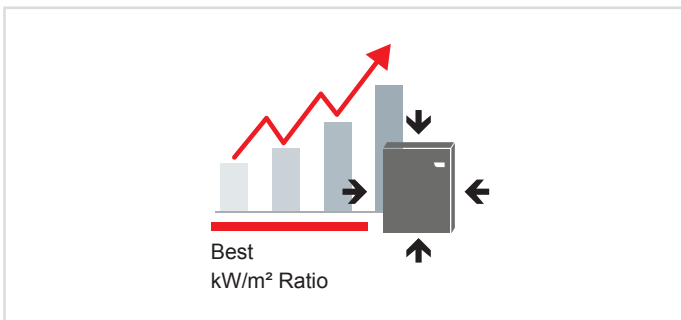

Efficiency beyond expectations

A data center's air conditioning system accounts for over 40% of total data center energy consumption. An efficient approach to air conditioning can generate an enormous advantage in efficiency and reduction of operating costs.

s-MEXT system is characterized by high quality components and control logics aimed at managing the system in the most efficiency mode.

- DC inverter scroll for linear and continuous modulation of cooling capacity based on the load.
- DC fans for best modulation of the air flow.

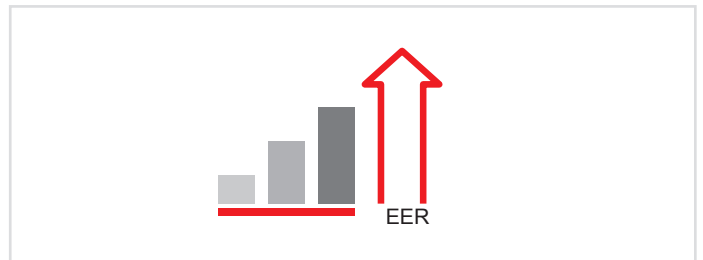

Flexibility in the air flows' choice

Flexible installation of the unit, thanks to the possibility of choosing between two air requirements: Under and Over.

Beyond the traditional Operational limits

The continuous increase of the thermal load in the IT environments has led to an increasing temperature inside the server rooms (up to 27°C) s-MEXT system has been developed to operate with return air temperature up to 35°C.

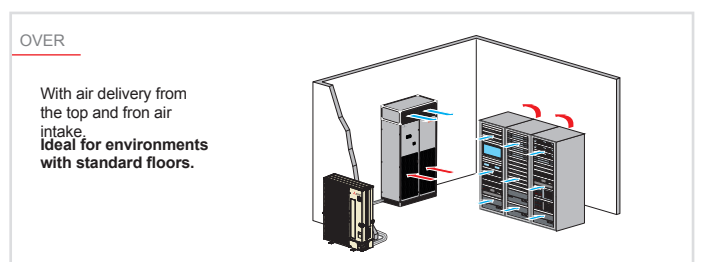
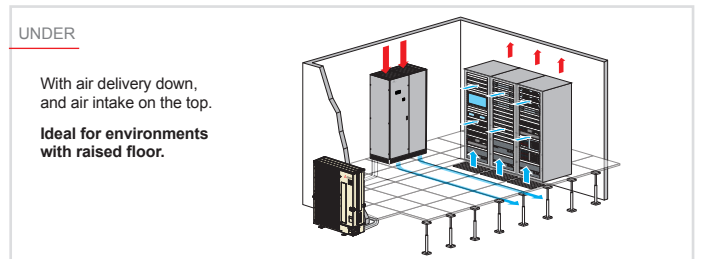
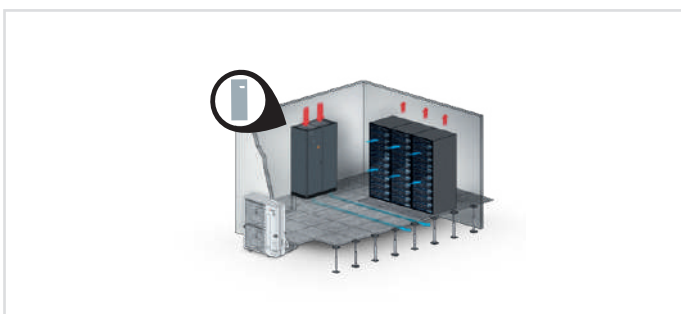

s-MEXT G00 Indoor Unit NEW

R410A

R32

PRECISION CONDITIONER
(INDOOR UNIT)

ABLE TO MANAGE TEMPERATURE
AND HUMIDITY VARIABLES, WITH
EXTREME PRECISION, EVEN IN
THE EVENTS OF LARGE LOADS
VARIATIONS

DESIGNED TO PERFECTLY COMBINE
EFFICIENCY AND RELIABILITY IN
ALL OPERATING CONDITIONS,
THESE INDOOR UNIT USES ONLY
CERTIFIED AND HIGH QUALITY
COMPONENTS: EC FAN, DX COIL
WITH HYDROLYSIS TREATMENT
AND ADVANCED CONTROL
SYSTEM.

A WIDE RANGE OF ACCESSORIES
COMPLETES THE SERIE AND
MAKES S-MEXT SUITABLE
FOR THE MOST CRITICAL
ENVIRONMENTAL'S CONDITIONS



Quick and easy installation

The construction features and the unit layout have been designed to ensure quick installation and facilitate front access for easy maintenance activity.

New EC inverter fan

High performance EC fan ensures a perfect modulation of air flow for partial loads. Made of ultra-light polymeric material, this fan is distinguished by:

- Sound level reduction by 4-5 dB(A);
- Reduction of 25% of power consumption, compared to traditional solutions.

Advanced Control System

Control System is the heart of the unit. Designed for monitoring and to operate the functional and environmental single unit's parameters. The Control System allows:

- Automatic reset after power failures;
- Serial interconnection with most modern BMS systems;
- up to 100 events recording;
- "Non-volatile" data storage for saving files;

Via simple and intuitive graphic display.



Technical specifications

MODEL			006	009	013	022	038	044
Outdoor unit	n°		1	1	1	1	2	2
	Model	PUHZ-ZRP	60 VHA2	100 VKA3	125 YKA3	250 YKA3	200 YKA3	250 YKA3
Cooling (1)		PUHZ-ZM	60 VHA	100 VKA	125 YKA	250 YKA	200 YKA	250 YKA
	Cooling capacity	kW	6,79	10,1	11,9	22,5	38,8	42,4
	Sensible	kW	6,28	9,0	10,3	19,5	34,0	37,5
	SHR (2)		0,92	0,89	0,87	0,87	0,88	0,88
	System EER (nominal) 27°C - 47% RH		3,92	3,98	2,97	2,87	3,15	2,59
	SUPPLY FAN	n°	1	1	1	2	1	1
	Air flow	m³/h	2000	2500	2800	5000	8800	10000
	Nominal external static pressure	Pa	20	20	20	20	20	20
	Maximum external static pressure	Pa	200	25	45	25	125	25
	Power input (3)	kW	0,21	0,37	0,52	0,74	1,43	2,10
	Absorbed current (3)	A	0,93	1,64	3,23	3,28	2,20	3,22
	Starting current	A	0,5	0,5	0,5	0,5	0,5	0,5
Plate current	A	2,3	2,3	3,15	4,6	4,2	4,2	
Electrical panel	Power input	kW	0,14	0,14	0,14	0,14	0,14	0,14
	Pressure level	dB(A)	53	57	61	60	63	67
Sound level (ISO 3744) (4)	Power level	dB(A)	69	73	77	76	79	83
	AIR FILTERS	n°	1	1	1	2	4	4
	Extended filtering surface	m²	0,68	0,68	0,68	1,05	1,76	1,76
	Efficiency (ISO EN 16890)	COARSE	60%	60%	60%	60%	60%	60%
	REFRIGERANT CIRCUITS	n°	1	1	1	1	2	2
	POWER SUPPLY	V/Ph/Hz	230/1/50	230/1/50	230/1/50	230/1/50	400/3+N/50	400/3+N/50
Dimensions	Length	mm	600	600	600	1000	1000	1000
	Depth	mm	500	500	500	500	890	890
	Height	mm	1980	1980	1980	1980	1980	1980
	NET WEIGHT Over	kg	103	115	115	185	297	297
	NET WEIGHT Under	kg	103	115	115	185	297	297
Connections	Refrigerant pipes: Gas - Liquid	Ø Inch	5/8" - 3/8"	5/8" - 3/8"	5/8" - 3/8"	1" - 1/2"	1" - 3/8"	1" - 1/2"
	Condensate (5)	Ø mm	19	19	19	19	19	19
	Power supply wiring cable (6)	n° x mm²	3G1.5	3G1.5	3G1.5	3G1.5	4G1.5	4G1.5

Notes:

THE COOLING CAPACITY DOES NOT CONSIDER THE SUPPLY FAN MOTOR THERMAL LOAD

(1) Gross value. Characteristics referred to entering air at 27°C-47% RH; Ambient temperature 35°C; ESP=20Pa; Connection pipes length 5m;

(2) SHR= Sensible cooling capacity / Total cooling capacity.

(3) Corresponding to the nominal ESP=20Pa.

(4) Sound pressure level on air return at 1m.

(5) Rubber pipe-referred to internal diameter.

(6) Minimum section.

These units contain <HFC R410A [GWP₁₀₀ 2088]> fluorinated greenhouse gas.

These units contain <HFC R32 [GWP₁₀₀ 675]> fluorinated greenhouse gas.

Mr. SLIM

NEW

OUTDOOR UNIT

OUTDOOR UNIT EQUIPPED WITH DC SCROLL INVERTER COMPRESSOR AND AXIAL FANS WITH DC ELECTRIC MOTOR

THE HEAT EXCHANGER IS THUS EXPLOITED ENTIRELY IN ITS EXCHANGE SURFACE.



OUTDOOR UNIT THAT BENEFIT FROM SCROLL COMPRESSOR, IS ALSO EQUIPPED WITH A DEVICE CALLED "POWER RECEIVER", A REFRIGERANT ACCUMULATOR ACCOMPANIED BY A PAIR OF LEV VALVES, WITH THE DUAL FUNCTION (SUBCOOLING/OVERHEATING THE REFRIGERANT).

Technologies and Functions

Mr.Slim presents excellent performances in all loading conditions thanks to the sophisticated power inverter technology with advanced features:

- “Rotation and Backup” function for automatic switching on a second unit in case of first unit block.
- “Easy and fast maintenance” function and automatic monitoring of the refrigerant status.

Linear Expansion Valve (LEV)

The Mr.Slim linear expansion valve (LEV) allows precise regulation of the refrigerant flow, optimizing the compressor’s performances.

- Fast achievement of system stability.
- Quick adaptation to load fluctuations.

Scroll Inverter compressor

Full inverter technology applied to the compressor allows continuous modulation of the cooling capacity according to the real needs of the servers.

In this way the rotation speed is continuously modulated helping to significantly increase the efficiency for partial loads.

- Elimination of inrush currents;
- Energy consumption reduction for 25%, compared to traditional ON/OFF technology;
- Maximum reliability thanks to continuous modulation without annoying ON/OFF cycles.



Technical specifications

OUTDOOR UNIT			PUHZ-ZM 60VHA	PUHZ-ZM 100VKA	PUHZ-ZM 125YKA	PUHZ-ZM 250YKA	PUHZ-ZM 200YKA	PUHZ-ZM 250YKA
	Indoor unit model		006	009	013	022	038	044
	Outdoor unit to be coupled to the indoor	n°	1	1	1	1	2	2
	COMPRESSOR	n°	1	1	1	1	1	1
	Power INPUT	kW	1,19	1,88	2,82	6,01	4,33	6,01
	Refrigerant charge	kg	2,8	4	4	7,7	7,1	7,7
	CONDENSER FAN	n°	1	2	2	2	2	2
	Air flow	m³/h	3300	6600	7200	8400	8400	8400
	Power input	kW	0,06	0,06	0,06	0,2	0,2	0,2
Dimensions	Lenght	mm	950	1050	1050	1050	1050	1050
	Depth	mm	355	370	370	370	370	370
	Height	mm	943	1338	1338	1338	1338	1338
	NET WEIGHT	kg	70	116	125	135	135	135

Notes:

(1) Characteristics referred to ambient temperature 35°C – indoor air condition 27°C-47% UR - Connection pipes length 5m;

(2) Sound pressure level on unit front at 1m.

(3) Minimum section.

(4) For standard refrigerant charge.

(5) With additional refrigerant charge.

(*) Data are referred to single outdoor unit.

(+) from 71 to 100 m please refer to Mr Slim O&M Manual.

These units contain <HFC R32 [GWP₁₀₀ 675]> fluorinated greenhouse gas.



MULTIDENSITY modular system

Efficient, rational, plug & play solution for high density data rooms.
Full inverter VRF system for small & medium size it environments
with hot spots up to 50 kW.



Up to 8 indoor units connected to one OUTDOOR unit

High density hot spots are managed by indoor units connected to condensing units working together as a unique system.



Highest capacity per footprint

Thanks to the possibility to minimise the number of outdoor units, the overall footprint of the whole system is drastically reduced.

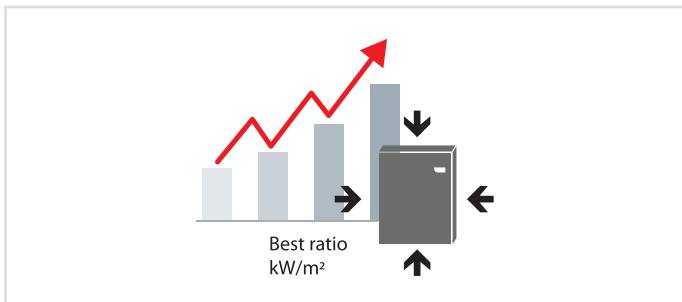

Choose your system's reliability

A multitude of configurations are available to provide customers with their desired level of reliability (configuration N, N+1, 2N). The Multidensity system is in line with TIER III and IV design topologies, based on the configuration chosen.

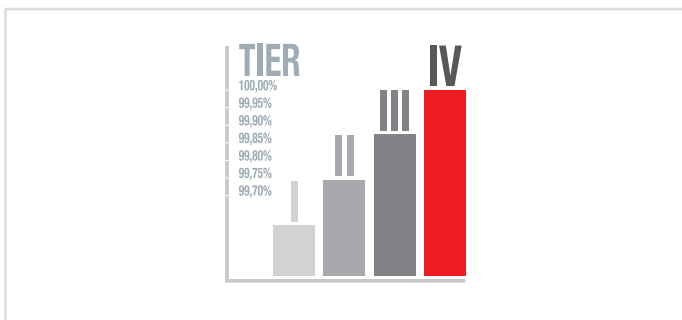

Adaptable flexibility

Match any kind of cooling requirement, from localised cooling to hot and cold aisle cooling management.

Rational design for optimised CAPEX

The rational design of the VRF system is combined with the experience and reliability of the Mitsubishi Electric brand, which guarantees the best quality for your IT infrastructure.

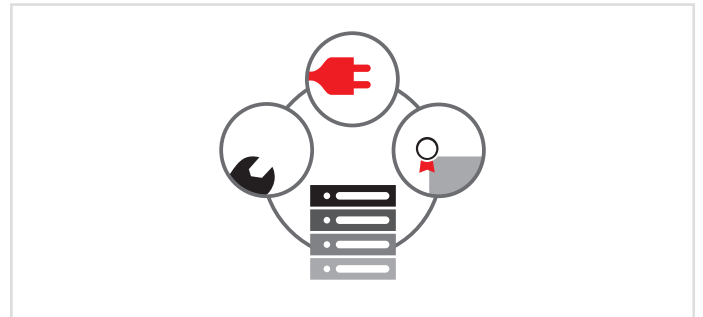

Plug and Play Installation

PLUG & PLAY SOLUTIONS No additional elements such as pumps, tanks, and valves are required. This installation simplicity results in a quicker start-up and more reliable maintenance, which are key factors for reducing installation and maintenance costs.

Active Redundancy

Active Redundancy Advanced load sharing logics of the Active Redundancy function ensure that the heat loads are balanced among the units (including those units that usually remain in stand-by) according to the actual requirements of the IT infrastructure, leveraging on the multi-unit configuration of redundant systems.

The modular approach of MULTIDENSITY SYSTEM

Indoor units are connected in master-slave configuration, if the master unit fails for any reason, the Dynamic Master logic automatically elects a new master from the other units.

Thanks to the flexible and modular approach of the MULTIDENSITY SYSTEM, it represents a tailored solution for any data center layout.

CONFIGURATION WITHOUT REDUNDANCY (N)

Ideal for small to medium IT rooms

- 1 external unit paired with up to 8 indoor units
- Average system EER is around 3.00
- Cooling capacity up to 50 kW

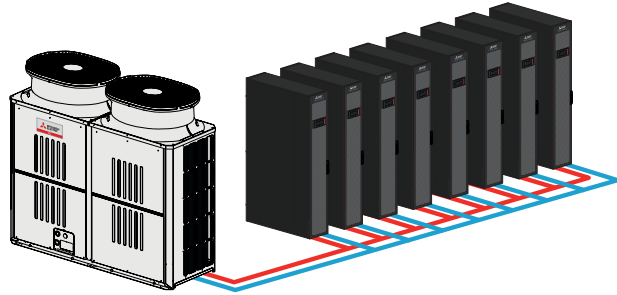

CONFIGURATION WITH REDUNDANCY (N+1)

Ideal for TIER II IT rooms

- 2 external units paired with up to 8 indoor units
- The external units operate in load sharing at partial loads for higher efficiency
- In case of failure of one of the condensing units, the second one operates at full load
- Average system EER is around 3.25
- Cooling capacity up to 50 kW

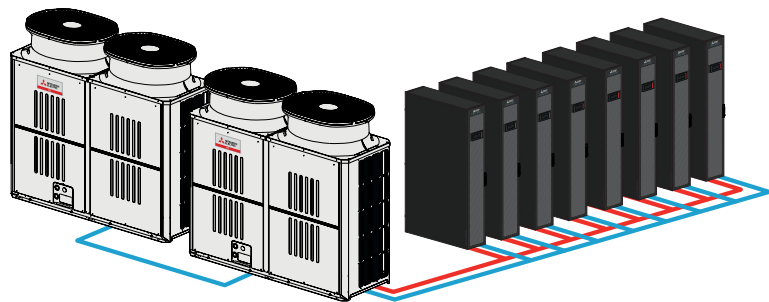

CONFIGURATION (2N)

Ideal for TIER III and TIER IV data centers

In accordance with the Uptime's Institute's classification, this configuration offers:

- A fully redundant and mirrored system with two independent distribution systems
- 1+1 external units paired with up to 8+8 indoor units

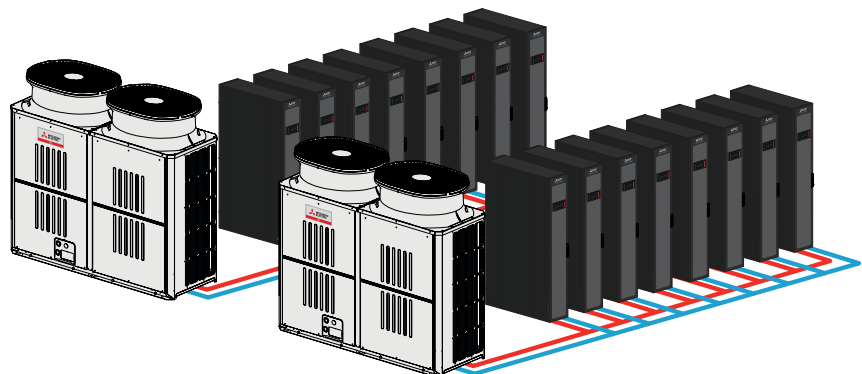

New evolution touch display

The evolution touch display is available for the room units m-MROW and m-MRAC.

Through simple, easy-to-read colour graphics, the innovative touch screen display (available as an option) shows the real performance of key components.

A completely redesigned interface improves the user experience. The 7" touch screen display ensures the immediate visualization of the indoor units' status thanks to dedicated screens for main operating parameter control: temperature, humidity, ventilation and then, alarms and event management.

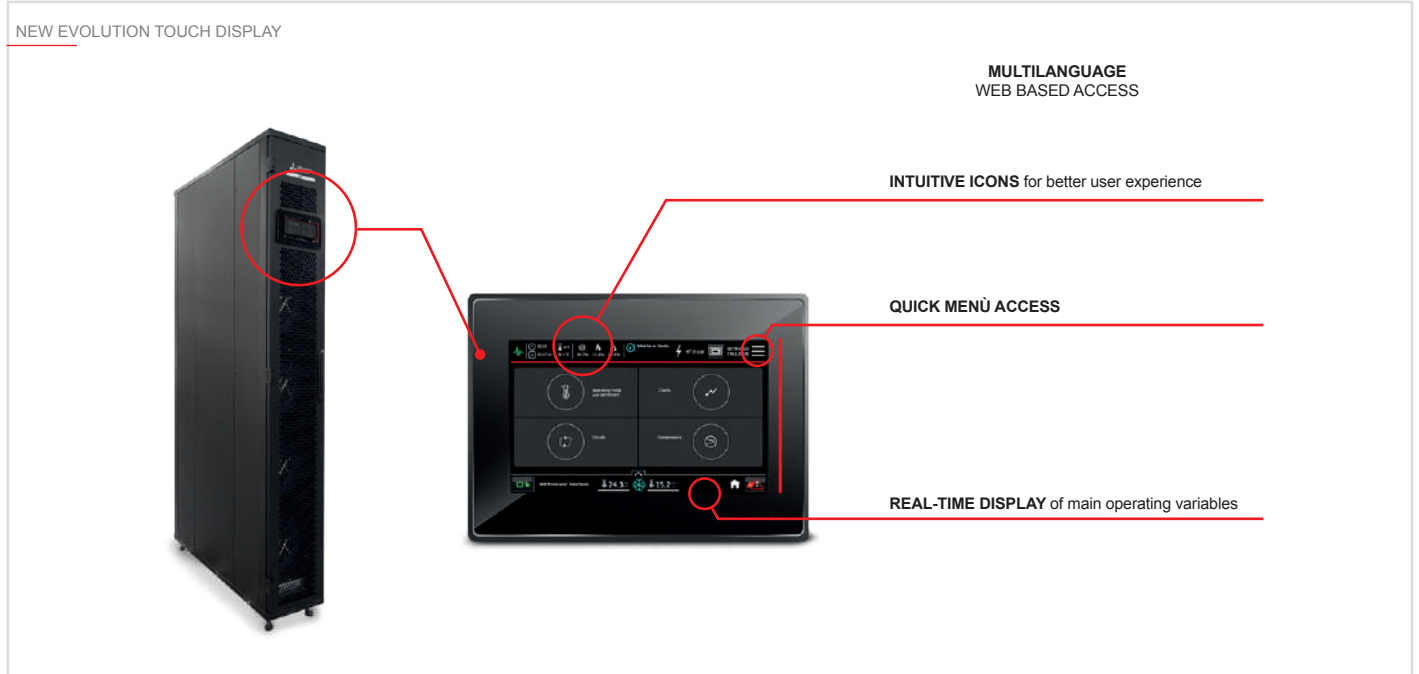

KIPLink innovative interface

Multidensity system is also available, as option, with KIPLink interface. Based on WI-FI technology, KIPLink gets rid of the standard keyboard and allows one to operate on the unit directly from a mobile devices (smartphone, tablet, notebook).



Dimensioning and design

Thanks to the sizing and design tool typical of Mitsubishi Electric direct expansion systems - New Design Tool – it's possible to simplify the design phases by minimizing the learning curve.



m-MOCU NEW

AIR-COOLED OUTDOOR UNIT FOR OUTDOOR INSTALLATION
TO BE COUPLED WITH IT COOLING INDOOR UNITS

mitsubishi electric's
experience in vrf
applied to it cooling
infrastructures

bell-mouth shape
designed propeller
fans with inverter
control brushless
dc motors

bldc scroll compressors
with inverter technology to
produce the exact output
needed by the system

modular design and
reduced footprint
for any installation
requirement

increased performance

extreme reliability

suitable for long
refrigerant pipe distance

low noise operation



Technical specifications CONDENSING UNITS				
Outdoor Unit			1x m-MOCU-G02-050	2x m-MOCU-G02-050
Cooling Capacity	Total ⁽¹⁾	kW	50	50
	System EER ⁽¹⁾	kW/kW	2.96	3.24
Unit Electrical Data	Power input ⁽¹⁾	kW	15.2	13.7
Compressor		Nr.	1	2x 1
	Power input ⁽¹⁾	kW	14.3	2x 14.3
Condenser Fans		Nr.	2	2x 2
	Total air flow	m ³ /h	19.200	2x 19.200
	Power input	kW	2x 0.92	4x 0.92
	External static pressure	Pa	0	0
Sound Level Iso 3744	Pressure level ⁽²⁾	dB(A)	65	68
Refrigerant Circuits		Nr.	1	2x 1
	Refrigerant type		R410A	R410A
	Pre-charged refrigerant	kg	11.8	2x 11.8
	F-GAS - CO ₂ equivalent	t	24.63	2x 24.63
Refrigerant Piping	Max pipe length (from the outdoor unit to the farthest indoor unit)	m	165	165
	Max height difference (outdoor unit higher than indoor units)	m	50	50
	Max height difference (outdoor unit lower than indoor units)	m	40	40
Power Supply		V/Ph/Hz	380-400-415 / 3+N / 50-60	380-400-415 / 3+N / 50-60
Dimensions	Length	mm	1750	2x 1750
	Depth	mm	740	2x 740
	Height	mm	1650	2x 1650
Net Weight		kg	304	2x 304

1. Gross Value. Characteristics referred to room air temperature 35°C with 27%RH and external ambient air temperature 35°C. ESP=20Pa.
2. Gross Value. Characteristics referred to room air temperature 46°C with 16%RH and external ambient air temperature 35°C. ESP=20Pa.
3. Sound pressure level on air return at 1m.

m-MROW NEW m-MRAC

THESE INDOOR RACK COOLING UNITS, FROM 10 TO 28 KW,
ARE DESIGNED TO BE CLOSE-COUPLED TO BLADE SERVERS AND MANAGE HOT SPOTS

OPTIMIZED FOR MULTIDENSITY
SYSTEM

REDUCED SPACE OCCUPANCY
(UP TO 0,36 M²)

COOLING ONLY WHERE NEEDED

EC PLUG FANS FOR
REDUCING ENERGY
CONSUMPTION
AND NOISE LEVELS

ELECTRONIC EXPANSION
VALVE TO ACHIEVE
A MUCH WIDER
MODULATION CAPACITY

BOTH IN-ROW AND
ENCLOSURE
VERSIONS AVAILABLE

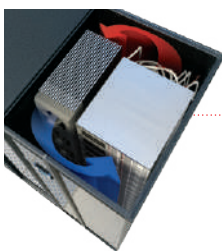

ENCLOSURE
IDEAL FOR REMOVING
HOT SPOTS IN STAND
ALONE SYSTEMS



IN ROW
IDEAL FOR HOT/COLD
AISLE CONFIGURATIONS

Technical specifications INDOOR UNITS					
Indoor unit			m-MROW-G02-009	m-MROW-G02-015	m-MROW-G02-025
			m-MRAC-G02-009	m-MRAC-G02-015	m-MRAC-G02-025
Unit size			9	15	25
Cooling capacity m-MROW	Total (1)	kW	10.6	16.6	28.6
	Sensible (1)	kW	9.6	15.7	27.4
	SHR (1)		0.91	0.94	0.96
	Indoor unit EER (1)	kW/kW	58.9	50.3	32.5
Cooling capacity m-MROW	Total (2)	kW	10.9	22.9	32.8
	Sensible (2)	kW	10.9	22.9	32.8
	SHR (2)		1	1	1
	Indoor unit EER (2)	kW/kW	60.5	69.3	37.2
Supply fan		Nr.	2	4	5
	Air flow	m ³ /h	1500	2700	4200
	Power input	kW	0.18	0.34	0.85
	Nominal external static pressure	Pa	20	20	20
	Maximum external static pressure	Pa	60	60	60
Sound level ISO 3744	Pressure level (3)	dB(A)	63.5	64.5	70.5
	Power level	dB(A)	79.0	80.0	86.0
Air filters		Nr.	2	2	2
	Extended filtering surface	m ²	0.35	0.35	0.35
	Efficiency (ISO EN 16890)	COARSE	40%	40%	40%
Refrigerant circuits		Nr.	1	1	1
	POWER SUPPLY	V/Ph/Hz	230/1/50-60	230/1/50-60	230/1/50-60
Dimensions	Width	mm	300	300	300
	Length	mm	1000 / 1200	1000 / 1200	1000 / 1200
	Height	mm	2085	2085	2085
Net weight	m-MROW	kg	175	190	193
	m-MRAC	kg	185	200	203





LIVING ENVIRONMENTAL SYSTEMS

Centro Direzionale Colleoni
Viale Colleoni, 7 - Palazzo Sirio
20864 Agrate Brianza (MB)
tel. 039.60531 - fax 039.6053223
e-mail: clima@it.mee.com



The equipment described in this catalogue contain fluorinated gasses such as HFC-32 (GWP 675), HFC-410A (GWP 2088). Installation of those equipment must be executed by professional installer based on EU reg. 303/2008 and 517/2014

COMFORT & IT COOLING SYSTEMS
FULL PRODUCT CATALOGUE
E-2112250(17170) sostituisce E-2009250(16620)

Specifications are subject to change without notice



E-2112250



ies.mitsubishielectric.it/en/products/